

Antenna System Solutions Provider



CONTENTS

Single-band Antennas.....8

Multi-band Antennas.....47

TDD Antennas.....178

General Description

FET (Fixed Electrical Tilt)

The pointing angle of the elevation beam is factory set at 0°, 3°, 5°, 6° or 9°. Customized settings available on request.

MET (Manually adjustable, variable Electrical Tilt)

Using a hand operated adjustment mechanism, which is located at the bottom of the antenna, the pointing angle of the elevation beam can be continuously adjusted over the specified downtilt range.

RET (Remote adjustable, variable Electrical Tilt)

By remote adjustment from the base of the tower or from the network operational maintenance centre(OMC), the pointing angle of the elevation beam is continuously adjustable over the specified downtilt range.

A single connector interface on the bottom of the antenna provides the ability to select and adjust individual frequency band of a Multi-band antenna.

AISG protocol compliant

AISG v2.0 supplied as standard(3GPP UTRAN luant TS25.463 Remote Electrical Tilting)

AISG v1.0 supplied on request

RoHS

ZTT products are fully compliant with RoHS request.

NGMN-P-BASTA

All antennas are measured according to the specifications given in NGMN-P-BASTA White Paper Version 11.1.

Specifications

ZTT is continually improving products. Specifications may change any time without notice. Please see www.zttcable.com or contact sales for more current information.

ZTT Multiport & Tube Antenna Numbering System

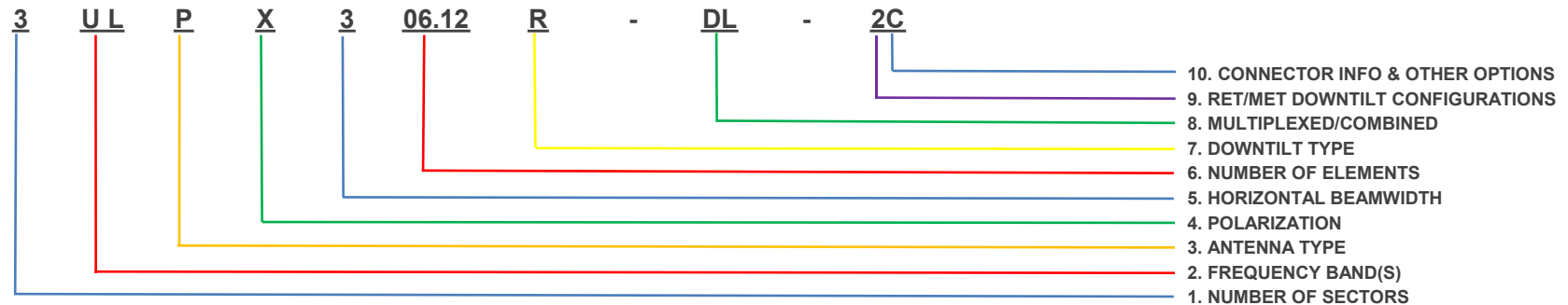

1. NUMBER OF SECTORS

2=2 sectors(OX)
3=3 sectors(OX)

2. FREQUENCY BAND(S)-MHz

D=698-896	L=1710-2690
G=790-960	H=2300-2700
U=698-960	V=3300-3800
J=617-960	C=1427-2690
W=1710-2170	S=2300-3800
R=3300-5000	N=4800-6000
T=300-500	B=1-300

3. ANTENNA TYPE

P=Panel Directional Antenna
O=Tube Antenna
N=Omni Antenna

4. POLARIZATION

X=±45° Dual Slant
A=Vertical or Horizontal
T=Vertical & Horizontal dual pol.

5. HORIZONTAL BEAMWIDTH

1=20deg(approximately)
2=33deg(approximately)
3=65deg(approximately)
4=90deg(approximately)
5=45deg(approximately)
6=120deg(approximately)

6. NUMBER OF ELEMENTS

06=6 elements at low band
12=12 elements at high band
When element number is the same, it can be omitted

7. DOWNTILT TYPE

F=Fixed tilt
M=Manual tilt
P=Replaceable RET
R=Remote tilt, 1 AISG interface
P2=2x AISG interface
F6=pre-configured etilt=6
SM=Slim & Manual tilt
B=Built-in SBT

8. MULTIPLEXED/COMBINED

DL=Diplexed on low band
DH=Diplexed on high band
DL2=2 arrays Diplexed on low band
DH4=4 arrays Diplexed on high band
CL=Diplexed on low band, co-downtilt
CL2=2 arrays Diplexed on low band, co-downtilt
CL2DH4=2 arrays Diplexed on low band, co-downtilt, 4 arrays Diplexed on high band, independent downtilt

9. RET/MET DOWNTILT CONFIGURATIONS

0=tilting range 10deg, tilt start at 0deg.
2=tilting range 10deg, tilt start at 2deg.
5=tilting range 15deg, tilt start at 5deg

10. CONNECTOR INFO & OTHER OPTIONS

V1, V2, ...=Different part number
1P=Combined high&low band with 1 Connectors coming out
2P=Combined high&low band with 2 Connectors coming out
4P=Combined high&low band with 4 Connectors coming out
N=N Female
G=equipped with GPS antenna
C=4.3-10 Female
D=DIN Female
Q=MQ4/MQ5
X=NEX10

ZTT Multibeam Antenna Numbering System

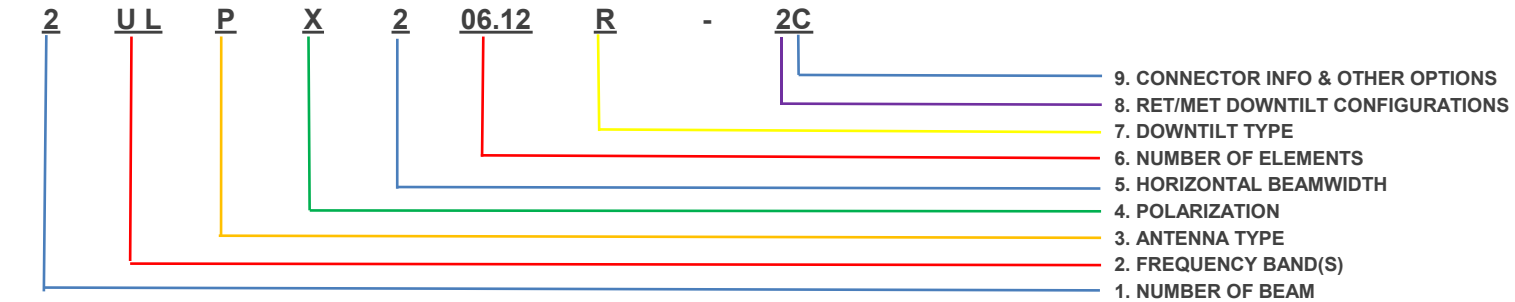

1. NUMBER OF BEAM

2=2 beams
3=3 beams
5=5 beams
6=6 beams
9=9 beams

3. ANTENNA TYPE

P=Panel Directional Antenna

4. POLARIZATION

X=±45° Dual Slant

7. DOWNTILT TYPE

F=Fixed tilt
R=Remote tilt, 1 AISG interface
P=Replaceable RET
P2=2x AISG interface

2. FREQUENCY BAND(S)-MHz

D=698-896	L=1710-2690
G=790-960	H=2300-2700
U=698-960	V=3300-3800
J=617-960	C=1427-2690
W=1710-2170	S=2300-3800
R=3300-5000	N=4800-6000
T=300-500	B=1-300

5. HORIZONTAL BEAMWIDTH

2=33deg(approximately)

6. NUMBER OF ELEMENTS

First number denotes the qty of X-axis elements.
Second number denotes the qty of Y-axis elements.
When element number is the same, it can be omitted

8. RET/MET DOWNTILT CONFIGURATIONS

0=tilting range 10deg, tilt start at 0deg.
2=tilting range 10deg, tilt start at 2deg.
5=tilting range 15deg, tilt start at 5deg

9. CONNECTOR INFO & OTHER OPTIONS

V1, V2, ...=Different part number
N=N Female
C=4.3-10 Female
D=DIN Female
Q=MQ4/MQ5
X=NEX10

ZTT Smart Antenna Numbering System

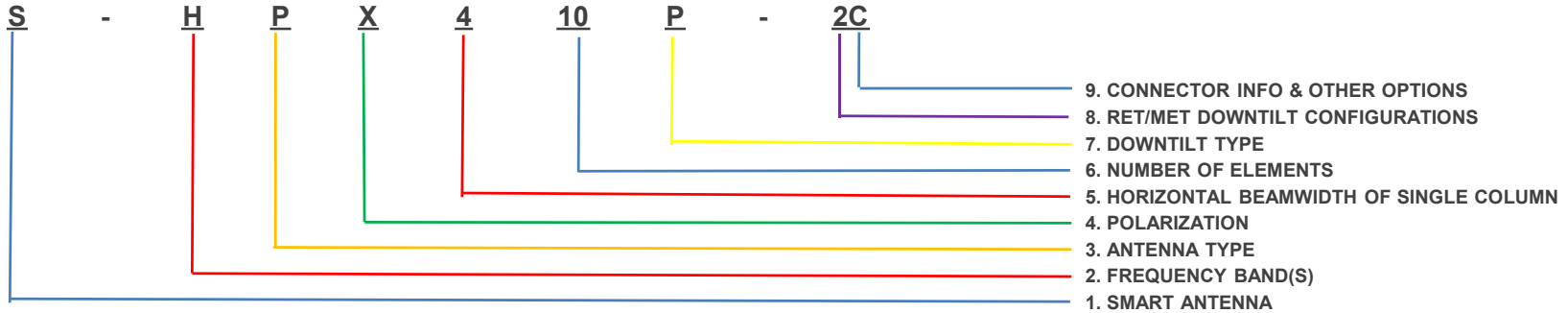

1. Smart Antenna

S=Smart Antenna

2. FREQUENCY BAND(S)-MHz

H=2300-2700 N=3800-5000
 V=3300-3800 S=2300-3800

3. ANTENNA TYPE

P=Panel Directional Antenna
 O=Tube Antenna

4. POLARIZATION

X= $\pm 45^\circ$ Dual Slant

5. HORIZONTAL BEAMWIDTH OF SINGLE COLUMN

3=65deg(approximately)
 4=90deg(approximately)
 It is defined by the band that beamwidth is the widest

6. NUMBER OF ELEMENTS

First 2 number denotes the qty of X-axis elements.
 Second 2 number denotes the qty of Y-axis elements.
 When element number is the same, it can be omitted

7. DOWNTILT TYPE

F=Fixed tilt
 M=Manual tilt
 P=Replaceable RET
 R=Remote tilt, 1 AISG interface
 P2=2x AISG interface
 F6=pre-configured etilt=6

8. RET/MET DOWNTILT CONFIGURATIONS

0=tilting range 10deg, tilt start at 0deg.
 2=tilting range 10deg, tilt start at 2deg.
 5=tilting range 15deg, tilt start at 5deg

9. CONNECTOR INFO & VERSION & OTHER OPTIONS

V1, V2, ...=Different part numbert
 C=4.3-10 Female
 D=DIN Female
 Q=MQ4/MQ5
 N=N Female

ZTT Hybrid Antenna Numbering System

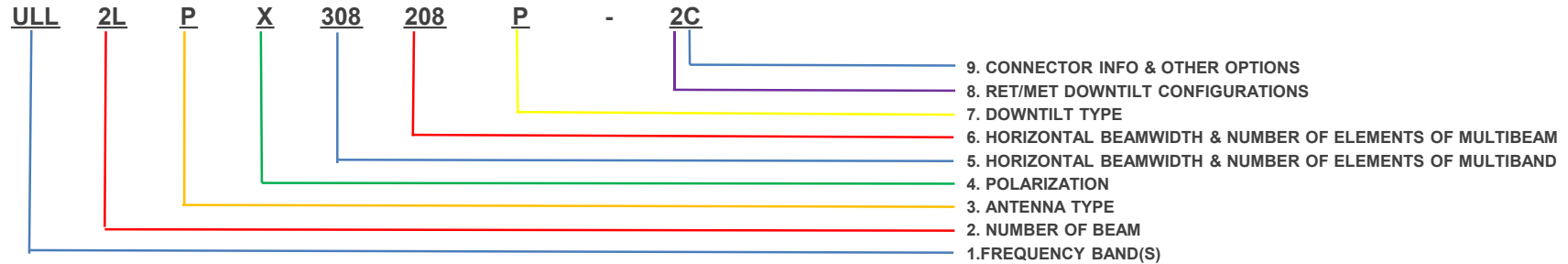

1. FREQUENCY BAND(S)-MHz
 U=698-960 H=2300-2700
 G=790-960 V=3300-3800
 D=698-896 C=1427-2690
 W=1710-2170 N=3800-5000
 L=1710-2690 S=2300-3800

2. NUMBER OF BEAM
 2=2 beams
 3=3 beams

3. ANTENNA TYPE
 P=Panel Directional Antenna
 O=Tube Antenna

4. POLARIZATION
 X=±45° Dual Slant

5. HORIZONTAL BEAMWIDTH & NUMBER OF ELEMENTS OF MULTIBAND
 First number denotes horizontal beamwidth
 2=33deg(approximately)
 3=65deg(approximately)
 Second & Third number denotes the qty of elements.
 When element number is the same, it can be omitted

6. HORIZONTAL BEAMWIDTH & NUMBER OF ELEMENTS OF MULTIBEAM
 First number denotes horizontal beamwidth
 2=33deg(approximately)
 3=65deg(approximately)
 Second & Third number denotes the qty of elements.
 When element number is the same, it can be omitted

7. DOWNTILT TYPE
 F=Fixed tilt
 M=Manual tilt
 P=Replaceable RET
 R=Remote tilt, 1 AISG interface
 P2=2xAISG interface
 F6=pre-configured etilt=6

8. RET/MET DOWNTILT CONFIGURATIONS
 0=tilting range 10deg, tilt start at 0deg.
 2=tilting range 10deg, tilt start at 2deg.
 5=tilting range 15deg, tilt start at 5deg

9. CONNECTOR INFO & VERSION & OTHER OPTIONS
 V1, V2, ...=Different part number
 1P=Combined high&low band with 1 Connectors coming out
 2P=Combined high&low band with 2 Connectors coming out
 4P=Combined high&low band with 4 Connectors coming out
 N=N Female
 C=4.3-10 Female
 D=DIN Female
 G=equiped with GPS antenna
 Q=MQ4/MQ5
 X=NEX10

Single-band Antennas

No.	Type	BR Part No.	Frequency(MHz)	HBW(deg)	Gain(dBi)	E-Tilt	Size mm(L*W*D)	Page
1	2 Ports	GPX205R	790-960	33	17.5	0-14°RET	1400×448×145	10
2	2 Ports	GPX209P-C	790-960	33	20	0-10°RET	2690×498×197	12
3	2 Ports	UPX209P-E2-C	698-960	33	19.5	2-12°RET	2490×498×197	15
4	2 Ports	UPX409P-C	698-960	90	15.5	0-10°RET	2495×270×149	18
5	2 Ports	LPX202F0-V1-C	1710-2690	33	14	0°FET	300×300×115	20
6	2 Ports	LPX210R	1710-2690	33	20	0-8°RET	1250×280×90	22
7	2 Ports	LPX303F3	1710-2690	65	12	3°FET	400×155×90	24
8	2 Ports	LPX306R-E2-C	1710-2690	65	15.5	2-12°RET	695×155×90	26

9	4 Ports	LPX310R-C	1710-2690	65	18	0-10°RET	1130×155×90	28
10	4 Ports	LLPX202F0	1710-2690/1710-2690	33/33	14	0°FET	550×300×115	31
11	4 Ports	LLPX207P-C	2×1710-2690	33	19	0-10° RET	940×504×118	33
12	4 Ports	LLPX303F6-C	1710-2690/1710-2690	65/65	12	6°FET	360×280×90	35
13	4 Ports	LLPX306F0-C	1710-2690/1710-2690	65/65	15	0°FET	700×280×90	37
14	4 Ports	LLPX306P-2C	2×1710-2690	65	15	2-12° RET	695×280×90	39
15	4 Ports	LLPX310P-2C	2×1710-2690	65	17	2-12° RET	1280×280×90	41
16	4 Ports	LLPX314P-C	2×1710-2690	65	19	0-8° RET	1700×280×90	43
17	4 Ports	VVPX202F0-V1	3300-3800/3300-3800	32/32	14/14	0°FET	400×155×90	45

★ denotes the preliminary issued antenna

Product Data Sheet

GPX205R

X Pol Panel Antenna 790-960MHz 33° 17.5dBi 0°-14° RET

Electrical Specifications

Frequency Range (MHz):	790-960(R1)		
	790-862	862-894	894-960
Gain (dBi):	16.5±0.5	17.2±0.5	17.5±0.5
Return Loss (dB):	>14 (VSWR<1.5)		
Polarization:	±45°		
Horizontal 3dB beamwidth (°):	38	35	32
Vertical 3dB beamwidth (°):	16	14.5	13
Electrical Downtilt (°):	0°-14° Independently Continuously Adjustable		
RET Type:	Cascade SRET, AISG 2.0, Upgradeable		
1 st Upper Sidelobe Level (dB):	15	15	15
Front to Back Ratio @180±30°(dB):	23	24	25
Cross Polar Ratio 0° (dB):	15	15	15
Cross Polar Ratio ±15° (dB):	10	10	10
Isolation Port to Port (dB):	>28		
Max. Power Per Port (W)	250		
Intermodulation IM3 (dBc):	<-150 (2×43 dBm)		
Impedance (ohm):	50		
Lightning Protection:	DC Grounded		
Connector Type:	2×7/16 DIN Female		

BASTA Electrical Specifications

Frequency Range(MHz):	790-960(R1)		
	790-862	862-894	894-960
Average Gain by Beam Tilts (dBi):	0° 16.65	0° 16.94	0° 17.26
	7° 16.39	7° 16.54	7° 16.83
	14° 16.07	14° 16.21	14° 16.45
Gain by all Beam Tilts Tolerance(dB):	±0.35	±0.42	±0.53
Horizontal Beamwidth Tolerance(°):	±1.42	±1.61	±2.27
Vertical Beam width Tolerance(°):	±0.92	±0.48	±0.89
Upper Side Lobe Suppression, Peak to 20°(dB):	15.19	15.06	15.32
Front to back Total Power at 180° ± 30°(dB)	25.01	27.55	25.97
CPR at Boresight(dB):	17.54	21.10	15.78

Mechanical Data

Antenna Dimensions (mm) :	1400×448×145
Packing Dimensions (mm) :	1685×530×235
Antenna Net Weight /Bracket (kg) :	16.5/5.9
Antenna Gross Weight (kg) :	26.5
Radome Material:	Fiberglass
Pipe OD (mm):	55-114
Mounting Kits (Included):	BA.K.04.00069131, Adjustable Downtilt 0°-16°

Environmental Ratings

Humidity:	95%RH@+30℃
Temperature (℃):	-40~+70
Wind Load @150 km/h (N):	Frontal/ Lateral/ Rearside: 833/119/926
Max. wind velocity (km/h):	200

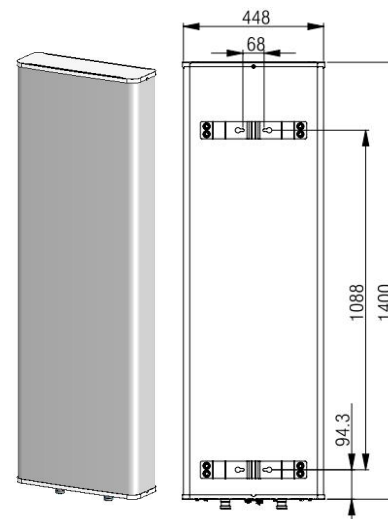

Product Data Sheet

GPX205R

Internal RET Specifications

RET type:	Integrated RET
RET protocol:	AISG 2.0 /3 GPP
Input voltage range(V):	10-30 DC
Power consumption(W):	< 5 (motor activated , single RET) < 1 (standby, single RET), < 1.5 (standby, 12V)
Adjustment time (full range) (s):	< 120 (typically, depending on antenna type)
RET connector:	1 pair of AISG 8 pin male & female
Pin assignment according AISG:	8 pin circular connector conforming to IEC 60130-9 - Ed. 3.0
Lightning protection (kA):	5 (8/20 μ s Differential mode), 8 (8/20 μ s Common mode)

Typical Patterns

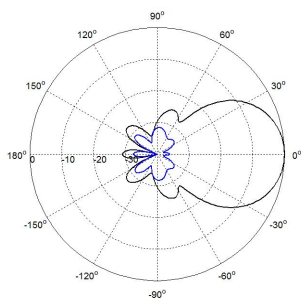

Azimuth

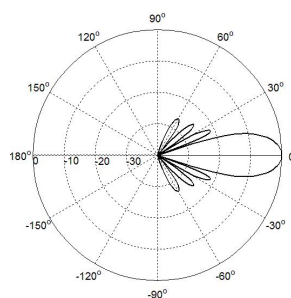

Elevation

Bottom View

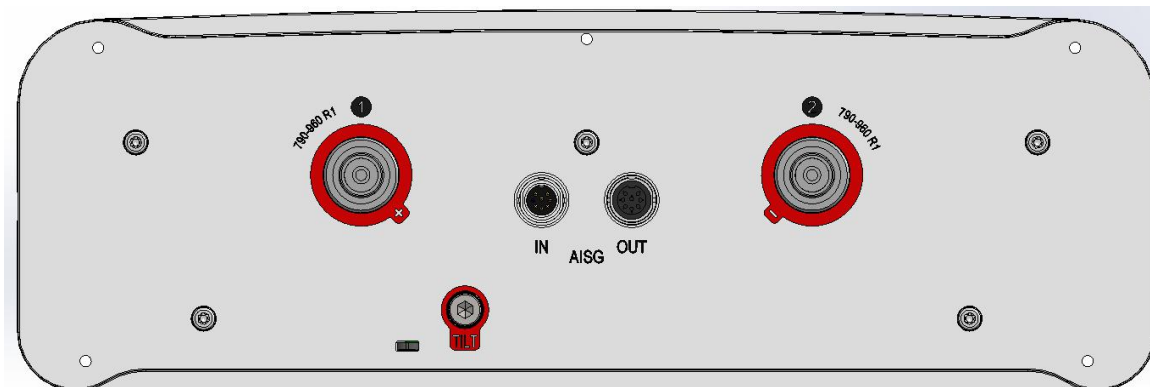

Correlation Table

Frequency range	Array	Connector	RET S/N
790-960MHz	R1	1-2	BRxxx.....1R1

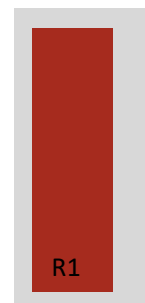

Product Data Sheet

GPX209P-C

X Pol Panel Antenna 790-960MHz 33° 20dBi 0°-10° Replaceable RET

Electrical Specifications

Frequency Range (MHz):	790-960(R1)		
	790-862	824-896	880-960
Gain (dBi):	18.6±0.5	19.0±0.5	19.3±0.5
Return Loss (dB):	>14 (VSWR<1.5)		
Polarization:	±45°		
Horizontal 3dB beamwidth (°):	35	33	30
Vertical 3dB beamwidth (°):	8.0	7.5	7.0
Electrical Downtilt (°):	0-10 Independently Continuously Adjustable		
RET Type:	Cascade SRET, AISG 2.0, Upgradeable		
1 st Upper Sidelobe Suppression (dB):	16	16	16
Front to Back Ratio @180±30°(dB):	24	24	24
Cross Polar Ratio 0° (dB):	15	15	15
Cross Polar Ratio ±15° (dB):	10	10	10
Isolation Port to Port (dB):	>28		
Max. Power Per Port (W):	250		
Intermodulation IM3 (dBc):	<-150 (2×43 dBm)		
Impedance (ohm):	50		
Lightning Protection:	DC Grounded		
Connector Type:	2×4.3-10 Female		

BASTA Electrical Specifications

Frequency Range(MHz):	790-960(R1)		
	790-862	862-894	894-960
Average Gain by all Beam Tilts (dBi):	18.32	18.65	18.93
Gain by all Beam Tilts Tolerance(dB):	±0.43	±0.35	±0.51
Average Gain by Beam Tilt (dBi):	2° 18.36 7° 18.32 12° 18.23	2° 18.51 7° 18.42 12° 18.36	2° 19.02 7° 18.93 12° 18.75
Horizontal Beamwidth Tolerance(°):	±2.77	±2.94	±2.53
Vertical Beamwidth Tolerance(°):	±0.57	±0.62	±0.59
1st Upper Sidelobe Suppression (dB) :	15.75	15.52	15.33
Front to back Total Power at 180° ± 30°(dB):	24.84	24.68	24.24
CPR at Boresight(dB):	21.29	20.29	20.16

Product Data Sheet

GPX209P-C

Mechanical Data

Antenna Dimensions (mm) :	2690×498×197
Packing Dimensions (mm) :	2960×585×290
Antenna Net Weight (kg) /Bracket (kg):	32/5.9
Antenna Gross Weight (kg) :	44
Radome Material:	Fiberglass
Pipe OD (mm):	50-115
Mounting Kits (Included):	BA.K.04.00069091, Adjustable Downtilt 0°-10°

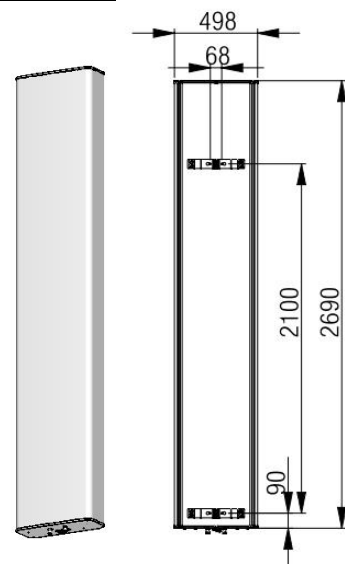

Environmental Ratings

Humidity:	95%RH@+30°C
Temperature (°C):	-40~+70
Wind Load @150 km/h (N):	Frontal/Lateral/Rearside: 1759/324/1785
Max. wind velocity (km/h):	150

Internal RET Specifications

RET type:	Replaceable RET
RET protocol:	AISG2.0 /3GPP
Input voltage range(V):	10-30 DC
Power consumption(W):	< 5 (motor activated, single RET) < 1 (standby, single RET), < 1.5 (standby, 12V)
Adjustment time (full range) (s):	< 120 (typically, depending on antenna type)
RET connector:	1 pair of AISG 8 pin male & female
Pin assignment according AISG:	8 pin circular connector conforming to IEC 60130-9 - Ed. 3.0
Lightning protection (kA):	5 (8/20 μs Differential mode), 8 (8/20 μs Common mode)

Typical Patterns

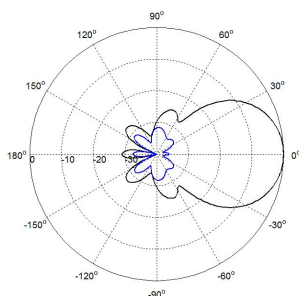

Azimuth

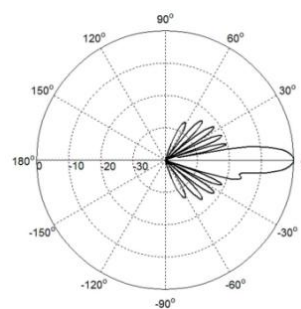

Elevation



GPX209P-C

Bottom View

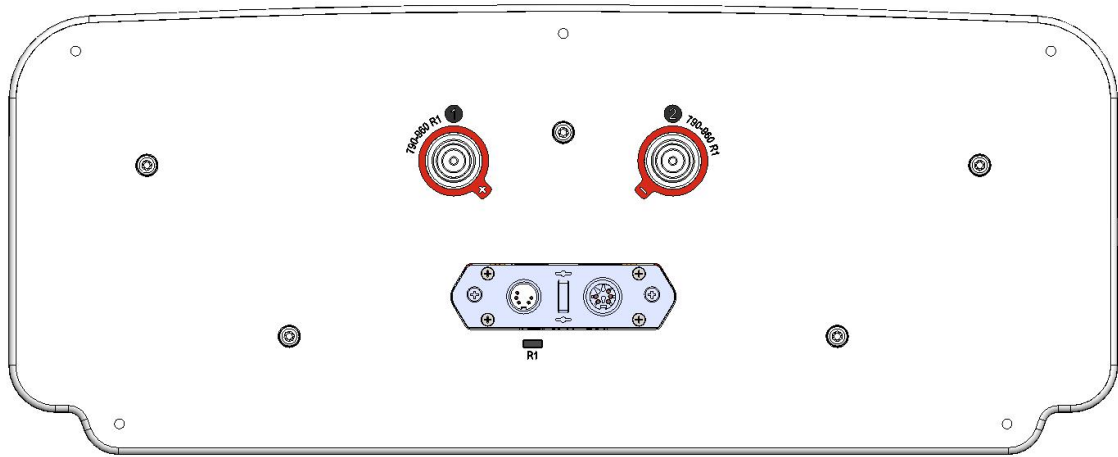

Correlation Table

Frequency range	Array	Connector
790-960MHz	R1	1-2

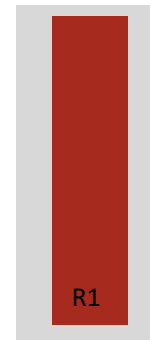

Product Data Sheet

UPX209P-E2-C

X Pol Panel Antenna 698-960MHz 33° 19.5dBi 2°-12° Replaceable RET

Electrical Specifications

Frequency Range (MHz):	698-960(R1)		
	698-862	862-894	894-960
Gain (dBi):	18.0±0.5	18.7±0.5	19.2±0.5
Return Loss (dB):	>14 (VSWR<1.5)		
Polarization:	±45°		
Horizontal 3dB beamwidth (°):	39	35	30
Vertical 3dB beamwidth (°):	9.2	8.0	7.0
Electrical Downtilt (°):	2-12 Independently Continuously Adjustable		
RET Type:	Cascade SRET, AISG 2.0, Upgradeable		
1 st Upper Sidelobe Suppression (dB):	15	15	15
Front to Back Ratio @180±30°(dB):	24	24	25
Cross Polar Ratio 0° (dB):	15	15	15
Cross Polar Ratio ±15° (dB):	10	10	10
Isolation Port to Port (dB):	>28		
Max. Power Per Port (W):	250		
Intermodulation IM3 (dBc):	<-150 (2×43 dBm)		
Impedance (ohm):	50		
Lightning Protection:	DC Grounded		
Connector Type:	2×4.3-10 Female		

BASTA Electrical Specifications

Frequency Range(MHz):	698-960(R1)		
	698-862	862-894	894-960
Average Gain by all Beam Tilts (dBi):	18.24	18.65	19.12
Gain by all Beam Tilts Tolerance(dB):	±0.53	±0.35	±0.61
Average Gain by Beam Tilt (dBi):	2° 18.30	2° 18.75	2° 19.22
	7° 18.23	7° 18.66	7° 19.10
	12° 18.17	12° 18.36	12° 18.85
Horizontal Beamwidth Tolerance(°):	±2.77	±2.94	±2.53
Vertical Beamwidth Tolerance(°):	±0.57	±0.62	±0.59
1st Upper Sidelobe Suppression (dB) :	15.35	15.62	15.53
Front to back Total Power at 180° ± 30°(dB):	24.84	25.18	25.84
CPR at Boresight(dB):	20.29	19.09	16.99

Product Data Sheet

UPX209P-E2-C

Mechanical Data

Antenna Dimensions (mm) :	2490×498×197
Packing Dimensions (mm) :	2760×585×290
Antenna Net Weight (kg) /Bracket (kg):	30.5/5.7
Antenna Gross Weight (kg) :	42.5
Radome Material:	Fiberglass
Pipe OD (mm):	50-114
Mounting Kits (Included):	BA.K.04.00069471, Adjustable Downtilt 0°-8°(0°-8°in 1°steps)

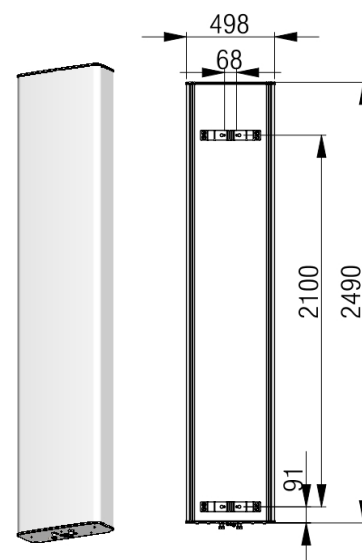

Environmental Ratings

Humidity:	95%RH@+30°C
Temperature (°C):	-40~+70
Wind Load @150 km/h (N):	Frontal/Lateral/Rearside: 2196/460/2315
Max. wind velocity (km/h):	150

Internal RET Specifications

RET type:	Replaceable RET
RET protocol:	AISG 2.0 /3 GPP
Input voltage range(V):	10-30 DC
Power consumption(W):	< 5 (motor activated, single RET) < 1 (standby, single RET), < 1.5 (standby, 12V)
Adjustment time (full range) (s):	< 120 (typically, depending on antenna type)
RET connector:	1 pair of AISG 5 pin male & female
Pin assignment according AISG:	8 pin circular connector conforming to IEC 60130-9 - Ed. 3.0
Lightning protection (kA):	5 (8/20 μs Differential mode), 8 (8/20 μs Common mode)

Typical Patterns

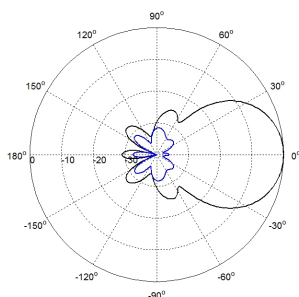

Azimuth

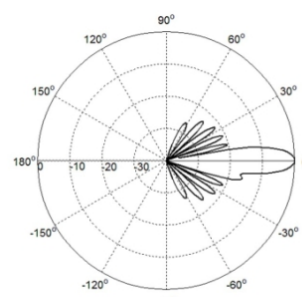

Elevation



UPX209P-E2-C

Bottom View

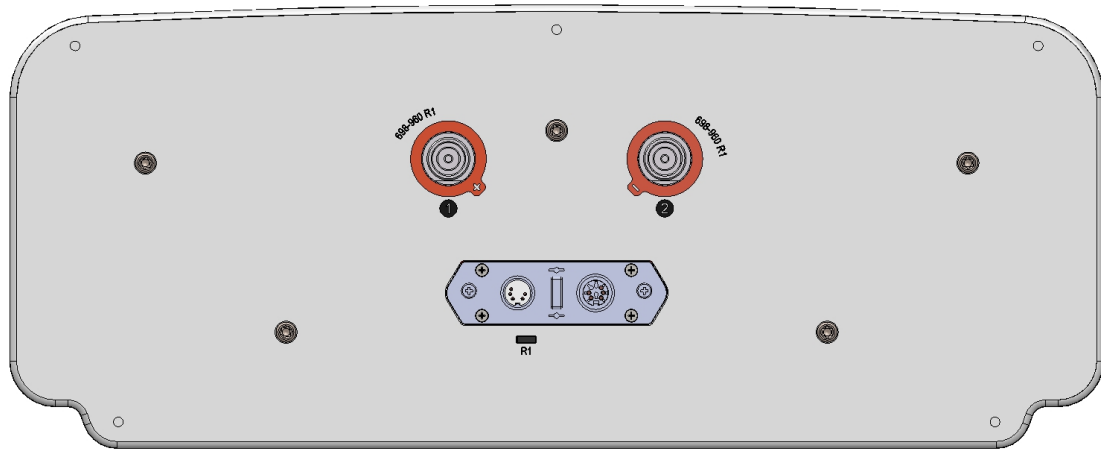

Correlation Table

Frequency range	Array	Connector	RET/S/N
698-960MHz	R1	1-2	BRXXX.....1R1



Product Data Sheet

UPX409P-C

X Pol Panel Antenna 698-960MHz 90° 15.5dBi 0-10°Replaceable RET

Electrical Specifications

Frequency Range (MHz):	698-960(R1)		
	698-862	862-894	894-960
Gain (dBi):	14.4±0.5	15.0±0.5	15.3±0.5
Return Loss (dB):	>14(VSWR<1.5)		
Polarization:	±45°		
Horizontal 3dB Beamwidth (°):	88	85	83
Vertical 3dB Beamwidth (°):	8.5	7.5	7.0
Electrical Downtilt (°):	0-10 Independently Continuously Adjustable		
RET Type:	Cascade SRET, AISG 2.0, Upgradeable		
1 st Upper Sidelobe Suppression (dB):	15	15	15
Front to Back Ratio (dB):	22	23	24
Isolation Port to Port (dB):	>28		
Max. Power Per Port (W):	250		
Intermodulation IM3 (dBc):	<-150 (2×43 dBm)		
Impedance (ohm):	50		
Lightning Protection:	DC Grounded		
Connector Type:	2×4.3-10 Female		

BASTA Electrical Specification

Frequency Range(MHz):	698-960(R1)		
	698-806	806-880	880-960
Average Gain by all Beam Tilts (dBi):	14.8	15	15.2
Gain by all Beam Tilts Tolerance(dB):	±0.4	±0.3	±0.3
Average Gain by Beam Tilt (dBi):	0° 14.8	0° 15.0	0° 15.3
	5° 14.9	5° 15.0	5° 15.4
	10° 14.7	10° 14.9	10° 15.0
Horizontal Beamwidth Tolerance(°):	±1.2	±0.8	±1
Vertical Beamwidth Tolerance(°):	±0.7	±0.5	±0.6
USLS to 20° above beampeak(dB):	17.7	15.3	16.6
Front to back Ratio at 180° ± 30°(dB)	22.2	23.8	24.3
CPR at Boresight(dB):	20.6	18.3	16.4

Mechanical Data

Antenna Dimensions (mm):	2495×270×149
Packing Dimensions (mm):	2765×355×240
Antenna Net Weight/Bracket (kg):	19/5.9
Antenna Gross Weight (kg):	29
Radome Material:	Fiberglass
Pipe OD (mm):	50-115
Mounting Kits (Included):	BA.K.04.00069091, Adjustable Downtilt 0-10°

Environmental Ratings

Humidity:	95%RH@+30℃
Temperature (℃):	-40~+70
Wind Load @150 km/h (N):	Frontal/Lateral/Rearside: 589/261/1096
Max. Wind velocity(km/h):	150

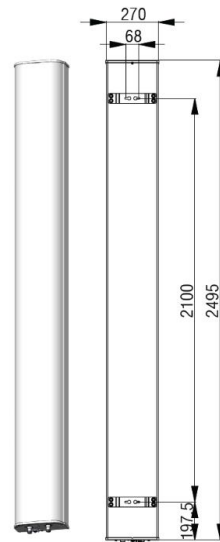

Product Data Sheet

UPX409P-C

Internal RET Specifications

RET Type:	Replaceable RET
RET protocol:	AISG2.0 /3GPP
Input voltage range(V):	10-30 DC
Power consumption(W):	< 5 (motor activated, single RET) < 1 (stand by, single RET), < 1.5 (stand by, 12V)
Adjustment time (full range) (s):	< 120 (typically, depending on antenna type)
RET connector:	1 pair of AISG 5 pin male & female
Pin assignment according AISG:	8 pin circular connector conforming to IEC 60130-9 - Ed. 3.0
Lightning protection (kA):	5 (8/20 μ s Differential mode), 8 (8/20 μ s Common mode)

Typical Patterns

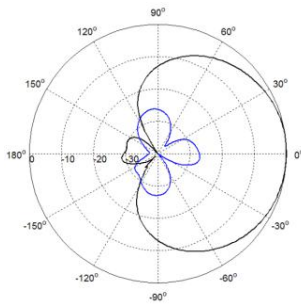

Azimuth(Low Band)

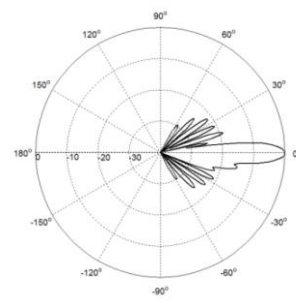

Elevation(Low Band)

Bottom View

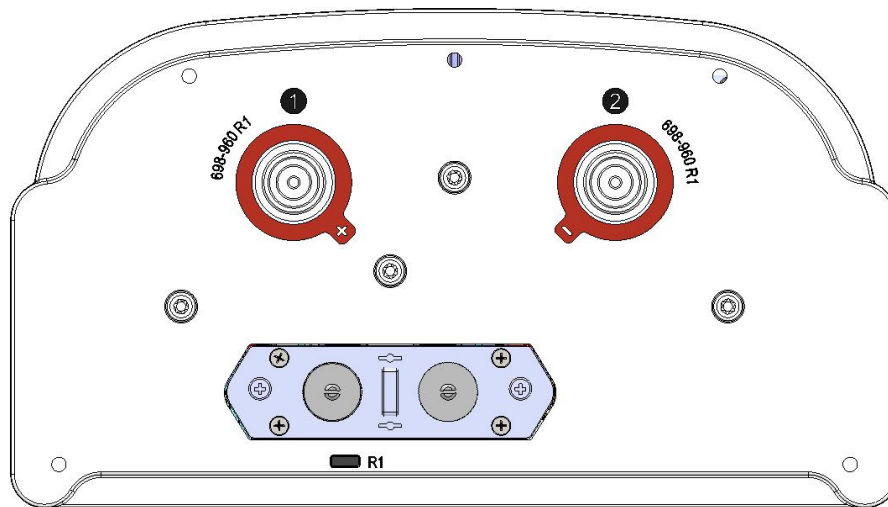

Correlation Table

Frequency range	Array	Connector	RET S/N
698– 960 MHz	R1	1-2	BRxxx.....1R1



Product Data Sheet

LPX202F0-V1-C

X Pol Panel Antenna 1710-2690MHz 33° 14dBi 0° Fixed Tilt 4.3-10 Connector

Electrical Specifications

Frequency Range (MHz):	1710-2690		
	1710-2170	2300-2500	2500-2690
Gain (dBi):	13.5±0.5	14.0±0.5	14.5±0.5
Return Loss (dB):	>14 (VSWR<1.5)		
Polarization:	±45°		
Horizontal 3dB beamwidth (°):	37	30	25
Vertical 3dB beamwidth (°):	37	30	25
Electrical Downtilt (°):	0 Fixed		
Horizontal Sidelobe(dB):	20	20	20
1 st Upper Sidelobe Suppression(dB):	20	20	20
Front to Back Ratio @180±30°(dB):	27	27	27
Cross Polar Ratio 0° (dB):	17	17	17
Cross Polar Ratio ±30° (dB):	10	10	8
Isolation Port to Port (dB):	>27		
Max. Power Per Port (W):	200		
Intermodulation IM3 (dBC):	<-150 (2×43 dBm)		
Impedance (ohm):	50		
Lightning Protection:	DC Grounded		
Connector Type:	2×4.3-10Female		

BASTA Electrical Specification

Frequency Range(MHz):	1710-2170	2300-2500	2500-2690
Average Gain by all Beam Tilts(dBi):	13.4	13.8	14.4
Gain by all Beam Tilts Tolerance(dB):	±0.3	±0.2	±0.2
3dB Horizontal Beamwidth Tolerance(°):	±4.2	±1.5	±1.5
3dB Vertical Beamwidth Tolerance(°):	±3.7	±3.5	±1.5
Upper Side Lobe Suppression, Peak to 20°(dB):	22	21.5	19.5
Front to back Total Power at 180° ± 30°(dB):	26	29	27
CPR at Boresight(dB):	25	24.5	22.5
Cross Polar Ratio ±30° (dB):	13	12	6

Mechanical Data

Antenna Dimensions (mm):	300×300×115
Packing Dimensions (mm):	535×395×220
Antenna Net Weight/Bracket (kg):	3.3/2.6
Antenna Gross Weight (kg):	8.3
Radome Material:	Fiberglass
Pipe OD (mm):	70-100
Mounting Kits (Included):	BA.K.04.00033, Horizontal adjustable±35°, Vertical adjustable±45°

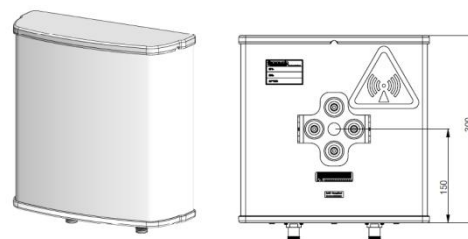

Environmental Ratings

Humidity:	95%RH@+30°C
Temperature (°C):	-40~+70
Wind Load @150 km/h (N):	Frontal/Lateral/Rearside: 143/24/167
Max. Wind velocity(km/h):	200

LPX202F0-V1-C

Typical Patterns

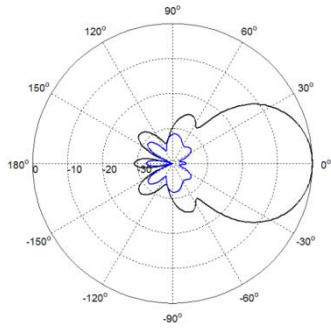

Azimuth

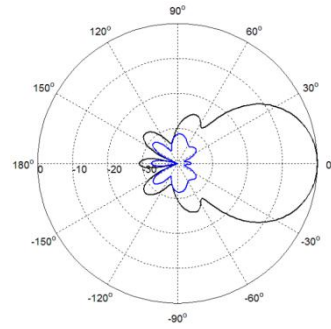

Elevation

Bottom View

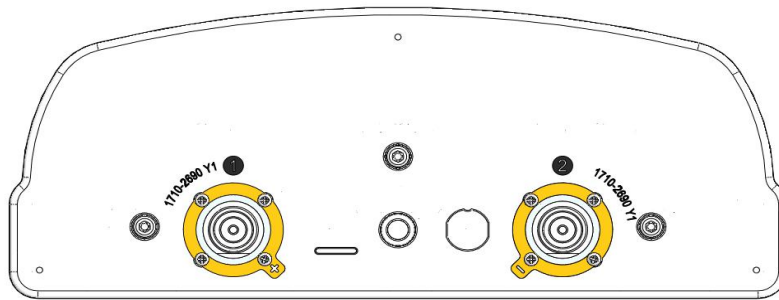

Correlation Table

Frequency range	Array	Connector
1710-2690 MHz	Y1	1-2

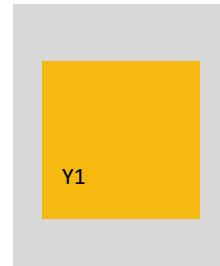

Product Data Sheet

LPX210R

X Pol Panel Antenna 1710-2690MHz 33°20dBi 0-8°RET

Electrical Specifications

Frequency Range (MHz):	1710-2690(Y1)				
	1710-1880	1880-2025	2025-2170	2300-2500	2500-2690
Gain(dBi):	19.3±0.5	19.8±0.5	20±0.5	20.2±0.5	20.5±0.5
Return Loss (dB):	>14 (VSWR<1.5)				
Polarization:	±45°				
Horizontal 3dB beamwidth (°):	35	32	30	28	25
Vertical 3dB beamwidth (°):	7.5	7.0	6.5	6.0	5.5
Electrical Downtilt (°):	0-8Independently Continuously Adjustable				
1 st Upper Sidelobe Suppression (dB):	>16				
Front to Back Ratio (dB):	>25				
Cross Polar Ratio 0° (dB):	>17				
Cross Polar Ratio ±60° (dB):	>10				
Isolation Port to Port(dB):	>28				
Max. Power Per Port (W):	300				
Intermodulation IM3 (dBc):	<-150 (2×43 dBm)				
Impedance (ohm):	50				
Lightning Protection:	DC Grounded				
Connector Type:	2×7/16 DIN Female				

BASTA Electrical Specifications

Frequency Range(MHz):	2×1710-2690(Y1)
Average Gain by all Beam Tilts (dBi):	20.1
Gain by all Beam Tilts Tolerance(dB):	±0.72
Average Gain by Beam Tilt (dBi):	0° 20.2 4° 20.3 8° 19.8
Horizontal Beamwidth Tolerance(°):	±5.32
Vertical Beamwidth Tolerance(°):	±1.46
USLS beampeak to 20° above beampeak(dB):	16.95
Front to back Total Power at 180° ± 30°(dB):	30.75
CPR at Boresight(dB):	22.04

Mechanical Data

Antenna Dimensions (mm):	1250×280×90
Packing Dimensions (mm):	1618×380×150
Antenna Net Weight/Bracket (kg):	10/5.7
Antenna Gross Weight (kg):	19
Radome Material:	Fiberglass
Pipe OD (mm):	70-114
Mounting Kits (Included):	BA.K.04.00011,Adjustable Downtilt0-16°

Environmental Ratings

Humidity:	95%RH@+30°C
Temperature (°C):	-50~+80
Wind Load @150 km/h (N):	Frontal/Lateral/Rearside: 593/85/675
Max. Wind velocity(km/h):	200

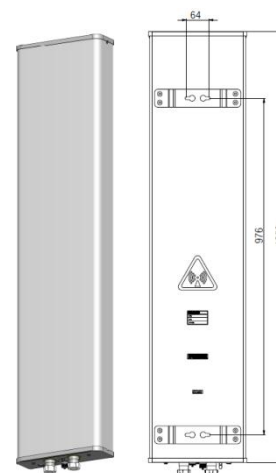

LPX210R

Internal RET Specifications

RET type:	Integrated RET
RET protocol:	AISG2.0 /3GPP
Input voltage range(V):	10-30 DC
Power consumption(W):	< 5 (motor activated ,single RET) < 1 (stand by, single RET), < 1.5 (stand by, 12V)
Adjustment time (full range) (s):	< 120 (typically, depending on antenna type)
RET connector:	1 pair of AISG 8 pin male & female
Pin assignment according AISG:	8-pin circular connector conforming to IEC 60130-9 - Ed. 3.0
Lightning protection(kA):	5 (8/20 μ s Differential mode), 8 (8/20 μ s Common mode)

Typical Patterns

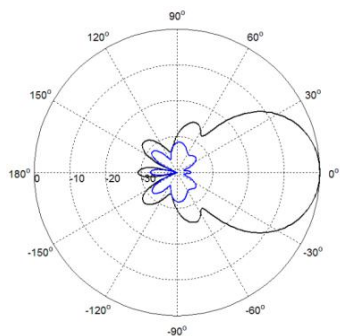

Azimuth

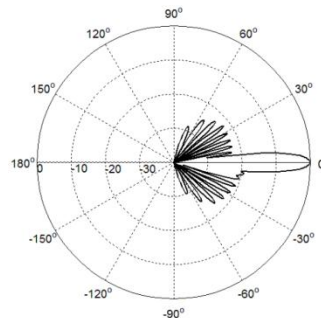

Elevation

Correlation Table

Frequency range	Array	Connector
1710-2690	Y1	1-2

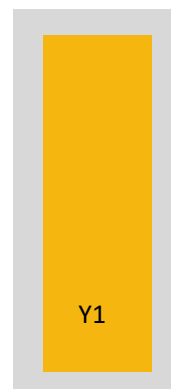

Bottom View

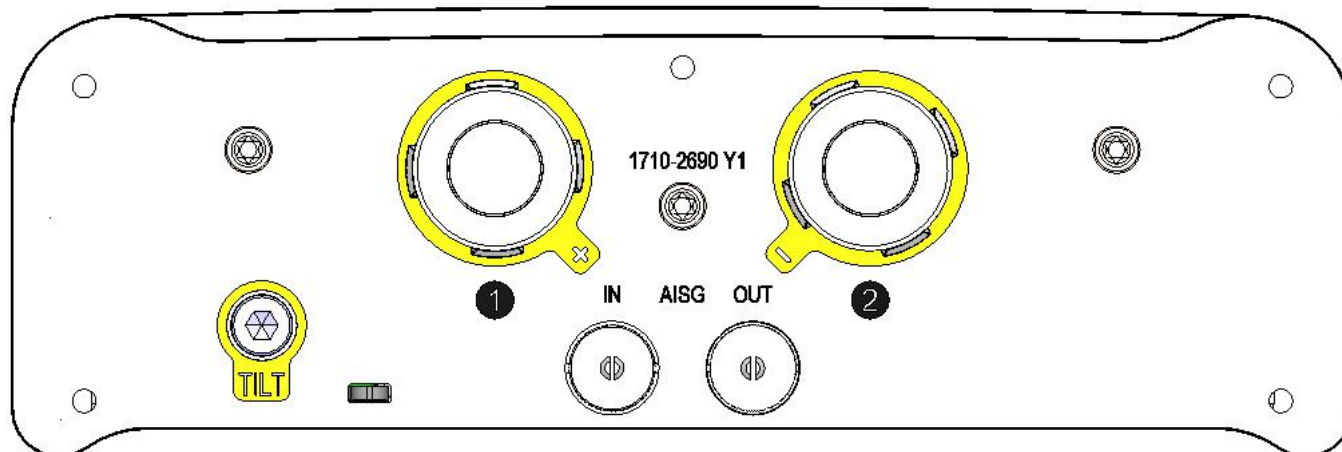

Product Data Sheet

LPX303F3

X Pol Panel Antenna 1710-2690MHz 65° 12dBi 3° FET

Electrical Specifications

Frequency Range (MHz):	1710-1880	1880-2025	2025-2170	2300-2500	2500-2690
Gain (dBi):	11.0	11.2	11.5	11.8	12.0
Return Loss (dB):	>14(VSWR<1.5)				
Horizontal 3dB Beamwidth (°):	70	68	66	64	62
Vertical 3dB Beamwidth (°):	30	28	26	25	22
Polarization:	±45°				
Electrical Downtilt (°):	3				
Isolation (dB):	>25				
Front to Back Ratio (dB):	>23				
Cross Polar Ratio 0° (dB):	>15				
Cross Polar Ratio ±60° (dB):	>10				
Intermodulation IM3 (dBc):	<-150 (2×43 dBm)				
Power Rating (W):	150				
Lightning Protection:	DC Grounded				

BASTA Electrical Specifications

Frequency Range (MHz):	1710-1880	1880-2025	2025-2170	2300-2500	2500-2690
Average Gain by all Beam Tilts (dBi):	11.4	11.6	12.5	12.3	12.4
Gain by all Beam Tilts Tolerance (dB):	0.2	0.5	0.3	0.4	0.3
Average Gain by Beam Tilt (dBi):	11.4	11.6	12.5	12.3	12.4
Horizontal Beamwidth Tolerance (°):	2.5	3.5	2.5	4	2
Vertical Beamwidth Tolerance (°):	2	1.5	1	1	1
USLS beampeak to 20° above beampeak (dB):	16				
Front to back Total Power at 180° ± 30° (dB):	26	25.6	27	28	28
CPR at Boresight (dB):	24				
CPR at Sector (dB):	12				

Mechanical Data

Antenna Dimensions (mm):	400×155×90
Packing Dimensions (mm):	616×351×206
Antenna Net Weight (kg):	2.1
Antenna Gross Weight (kg):	5
Connector Type:	2×7/16 DIN Female
Radome Material:	FRP
Pipe OD (mm):	70-114
Mounting Kits (Included):	Horizontal adjustable: -35°~+35° Vertical adjustable: -45°~+45°

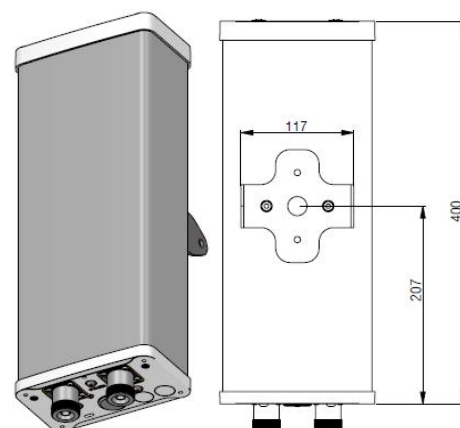

Environmental Ratings

Humidity:	95%RH@+30°C
Temperature (°C):	-40~+70
Wind Load @150 km/h (N):	Frontal/Lateral/Rearside: 114/44/118

LPX303F3

Typical Patterns

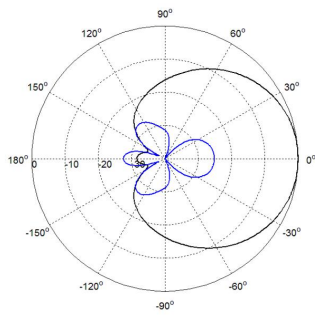

Azimuth

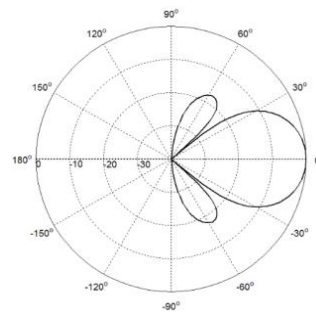

Elevation

Bottom View



Product Data Sheet

LPX306R-E2-C

X Pol Panel Antenna 1710-2690MHz 65° 16dBi 2°-12° RET

Electrical Specifications

Frequency Range (MHz):	1710-2690(Y1)		
	1710-2170	2300-2490	2490-2690
Gain (dBi):	14.6±0.5	15.0±0.5	15.3±0.5
Return Loss (dB):	>14 (VSWR<1.5)		
Polarization(°):	±45°		
Horizontal 3dB Beamwidth (°):	69	63	58
Vertical 3dB Beamwidth (°):	14.5	11.0	10.0
Electrical Downtilt (°):	2-12 Independently Continuously Adjustable		
RET Type:	RET Cascade SRET, AISG 2.0, Upgradeable		
1 st Upper Sidelobe Suppression (dB):	15	15	15
Front to Back Ratio (dB):	>25	>25	>25
Cross Polar Ratio 0° (dB):	15	15	15
Cross Polar Ratio ±60° (dB):	>10	>8	>6
Isolation Port to Port(dB):	>25		
Max. Power Per Port (W):	200		
Intermodulation IM3 (dBC):	<-150 (2×43dBm)		
Impedance (ohm):	50		
Lightning Protection:	DC Grounded		
Connector Type:	2×4.3-10 Female		

BASTA Electrical Specifications

Frequency Range(MHz):	1710-2690(Y1)		
	1710-2170	2300-2490	2490-2690
Average Gain by Beam Tilts (dBi):	2° 15.21	2° 15.38	2° 15.32
	7° 14.90	7° 15.01	7° 14.98
	12° 14.62	12° 14.70	12° 14.68
Gain by all Beam Tilts Tolerance(dB):	±0.53	±0.60	±0.66
Horizontal BeamwidthTolerance(°):	±4.68	±2.08	±3.53
Vertical Beamwidth Tolerance(°):	±1.93	±0.99	±0.42
Upper Side Lobe Suppression, Peak to 20°(dB):	15.38	15.97	16.01
Front to back Total Power at 180° ± 30°(dB)	25.27	26.42	26.59
CPR at Boresight(dB):	18.96	17.77	18.52

Mechanical Data

Antenna Dimensions (mm):	695×155×90
Packing Dimensions (mm):	1040×240×185
Antenna Net Weight/Bracket (kg):	4/1.5
Antenna Gross Weight (kg):	7.5
Radome Material:	Fiberglass
Pipe OD (mm):	70-114
Mounting Kits (Included):	BA.K.04.00013, Adjustable Downtilt 0°-15°

Environmental Ratings

Humidity:	95%RH@+30°C
Temperature (°C):	-40~+70
Wind Load @150 km/h (N):	Frontal/Lateral/Rearside:150/58/154
Max.Wind velocity(km/h):	200

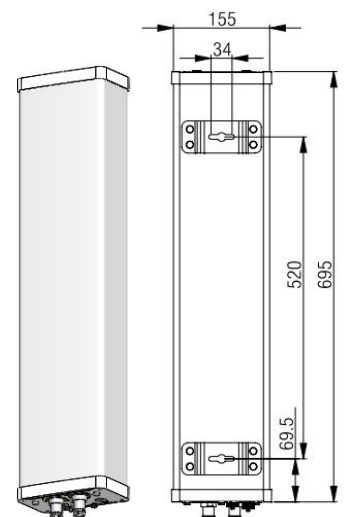

LPX306R-E2-C

Internal RET Specifications

RET Type:	Integrated RET
RET protocol:	AISG2.0 /3GPP
Input voltage range(V):	10-30 DC
Power consumption(W):	< 5 (motor activated, single RET) < 1 (stand by, single RET), < 1.5 (stand by, 12V)
Adjustment time (full range) (s):	< 120 (typically, depending on antenna type)
RET connector:	1 pair of AISG 8 pin male & female per sector
Pin assignment according AISG:	8pin circular connector conforming to IEC 60130-9 - Ed. 3.0
Lightning protection (kA):	5 (8/20 μs Differential mode), 8 (8/20 μs Common mode)

Typical Patterns

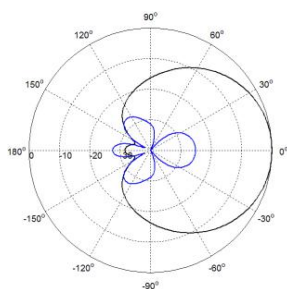

Azimuth

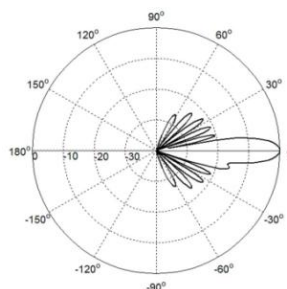

Elevation

Bottom View

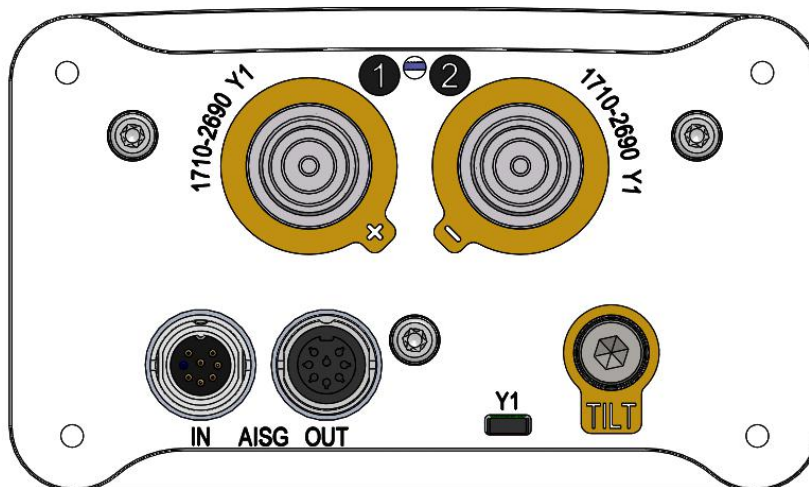

Correlation Table

Frequency range	Array	Connector	RET S/N
1710–2690 MHz	Y1	1-2	BRxxx.....1Y1

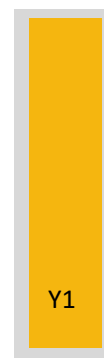

Product Data Sheet

LPX310R-C

X Pol Panel Antenna 1710-2690MHz 65° 18dBi 0°-10° RET

Electrical Specifications

Frequency Range (MHz):	1710-2690(Y1)		
	1710-2170	2200-2490	2490-2690
Gain (dBi):	16.8±0.5	17.2±0.5	17.5±0.5
Return Loss (dB):	>14 (VSWR<1.5)		
Polarization:	±45°		
Horizontal 3dB Beamwidth (°):	68	65	58
Vertical 3dB Beamwidth (°):	7.8	6.5	5.5
Electrical Downtilt (°):	0-10 Independently Continuously Adjustable		
RET Type:	RET Cascade SRET, AISG 2.0, Upgradeable		
1 st Upper Sidelobe Suppression(dB):	16	16	16
Front to Back Ratio (dB):	>25		
Cross Polar Ratio 0° (dB):	15	15	15
Cross Polar Ratio ±60° (dB):	10	9	8
Isolation Port to Port (dB):	>28		
Max. Power Per Port (W):	250		
Intermodulation IM3 (dBc):	<-150(2×43 dBm)		
Impedance (ohm):	50		
Lightning Protection:	DC Grounded		
Connector Type:	2×4.3-10 Female		

BASTA Electrical Specifications

Frequency Range(MHz):	1710-2690		
	1710-2170	2200-2490	2490-2690
Average Gain by all Beam Tilts (dBi):	16.64	16.93	17.23
Gain by all Beam Tilts Tolerance(dB):	±0.43	±0.35	±0.41
Average Gain by Beam Tilt (dBi):	0° 16.85 5° 16.66 10° 16.42	0° 17.25 5° 16.96 10° 16.73	0° 17.45 5° 17.20 10° 17.03
Horizontal Beamwidth Tolerance(°):	±4.77	±2.94	±2.53
Vertical Beamwidth Tolerance(°):	±0.82	±0.42	±0.38
1st Upper Sidelobe Suppression (dB) :	17.56	17.62	16.86
Front to back	27.84	27.18	26.84
Total Power at 180° ± 30°(dB):	27.84	27.18	26.84
CPR at Boresight(dB):	24.29	23.09	22.86



Product Data Sheet

LPX310R-C

Mechanical Data

Antenna Dimensions (mm):	1130×155×90
Packing Dimensions (mm):	1475×240×185
Antenna Net Weight/Bracket (kg):	5.5/1.5
Antenna Gross Weight (kg):	9
Radome Material:	Fiberglass
Pipe OD (mm):	70-114
Mounting Kits (Included):	BA.K.04.00013, Adjustable Downtilt 0°-15°

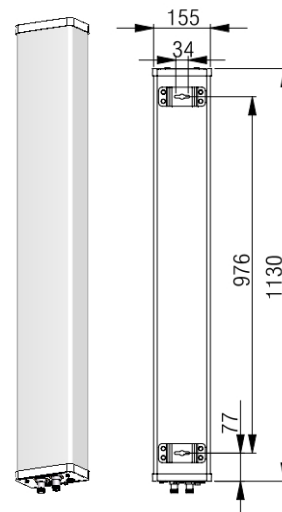

Environmental Ratings

Humidity:	95%RH@+30℃
Temperature (℃):	-40~+70
Wind Load @150 km/h (N):	Frontal/ Lateral/Rearside: 249/98/256
Max. Wind velocity(km/h):	200

Internal RET Specifications

RET type:	Integrated RET
RET protocol:	AISG2.0 /3GPP
Input voltage range(V):	10-30 DC
Power consumption(W):	< 5 (motor activated , single RET) < 1 (stand by, single RET), < 1.5 (stand by, 12V)
Adjustment time (full range): (s):	< 120 (typically, depending on antenna type)
RET connector:	1 pair of AISG 8 pin male & female per sector
Pin assignment according AISG:	8 pin circular connector conforming to IEC 60130-9 - Ed. 3.0
Lightning protection (kA):	5 (8/20 μs Differential mode), 8 (8/20 μs Common mode)

Typical Patterns

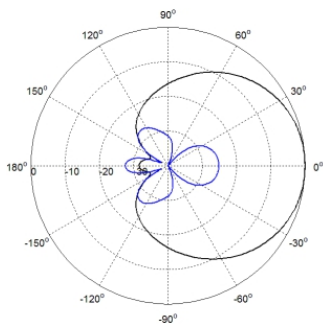

Azimuth

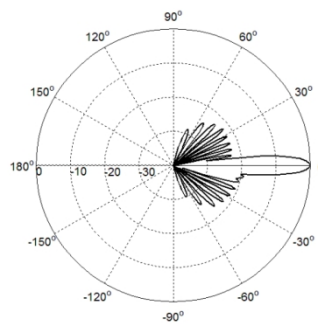

Elevation



LPX310R-C

Bottom View

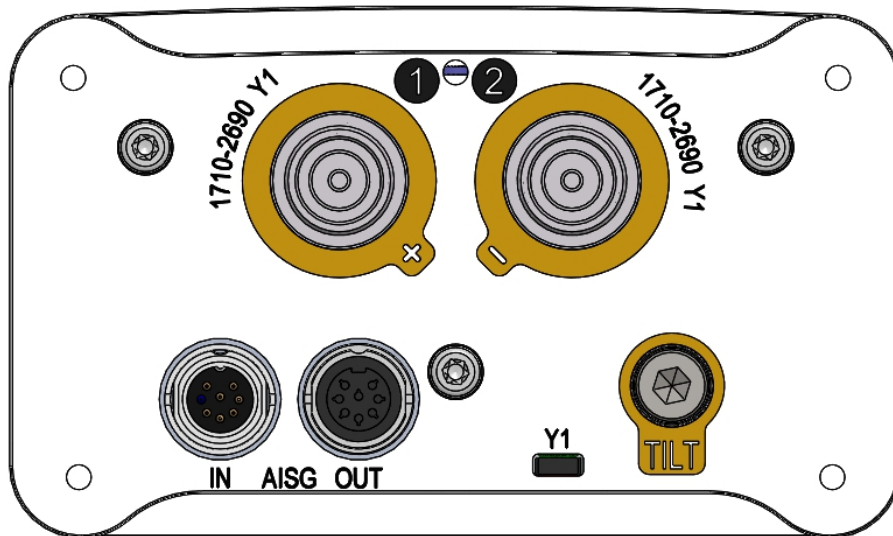

Correlation Table

Frequency range	Array	Connector	RET S/N
1710-2690MHz	Y1	1-2	BRXXX.....1Y1



Product Data Sheet

LLPX202F0

XX Pol Panel Antenna 1710-2690/1710-2690MHz 33°/33° 14/14dBi 0° FET

Electrical Specifications

Frequency Range (MHz):	2×1710-2690				
	1710-1880	1880-2025	2025-2170	2300-2500	2500-2690
Gain (dBi):	13.5±0.5	14.0±0.5	14.5±0.5	14.8±0.5	15.0±0.5
Return Loss (dB):	>14 (VSWR<1.5)				
Polarization (°):	±45				
Horizontal 3dB beamwidth (°):	36	35	34	30	27
Vertical 3dB beamwidth (°):	34	33	30	26	23
Electrical Downtilt (°):	0 Fixed				
Horizontal Sidelobe(dB):	15				
1 st Upper Sidelobe Level:	18	17	16	15	14
Front to Back Ratio @180±30°(dB):	25				
Cross Polar Ratio 0° (dB):	15				
Cross Polar Ratio ±30° (dB):	10				
Isolation Port to Port (dB):	>28				
Power Rating (W):	150				
Intermodulation IM3 (dBc):	<-150 (2×43 dBm)				
Impedance (ohm):	50				
Lightning Protection:	DC Grounded				
Connector Type:	4×7/16 DINFemale				

Mechanical Data

Antenna Dimensions (mm):	550×300×115
Packing Dimensions (mm):	757×410×256
Antenna Net Weight/Bracket (kg):	5.1/2.5
Antenna Gross Weight (kg):	8.65
Radome Material:	Fiberglass
Pipe OD (mm):	70-110 30-50(Optional)
Mounting Kits (Included):	BA.K.04.00040 horizontal adjustable -35°-+35°,vertical adjustable-45°-+45°

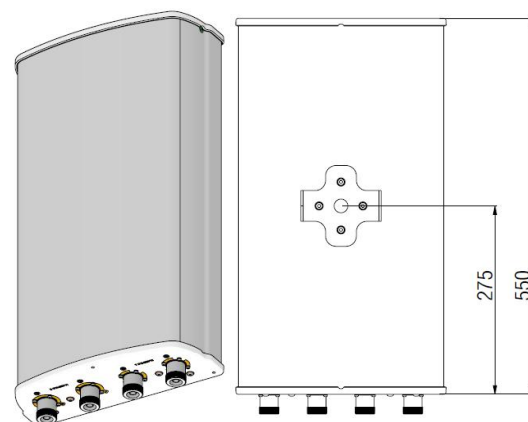

Environmental Ratings

Humidity:	95%RH@+30°C
Temperature (°C):	-40~+70
Wind Load @150 km/h (N):	Frontal/Lateral/Rearside: 269/44/314
Max.Wind velocity(km/h)	200

LLPX202F0

Typical Patterns

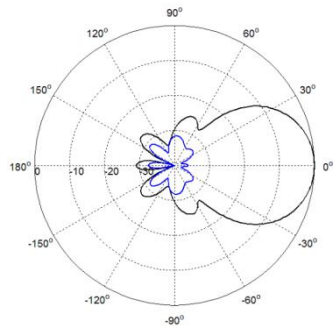

Azimuth

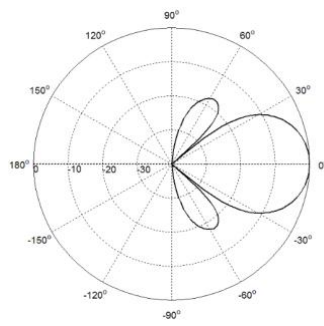

Elevation

Bottom View

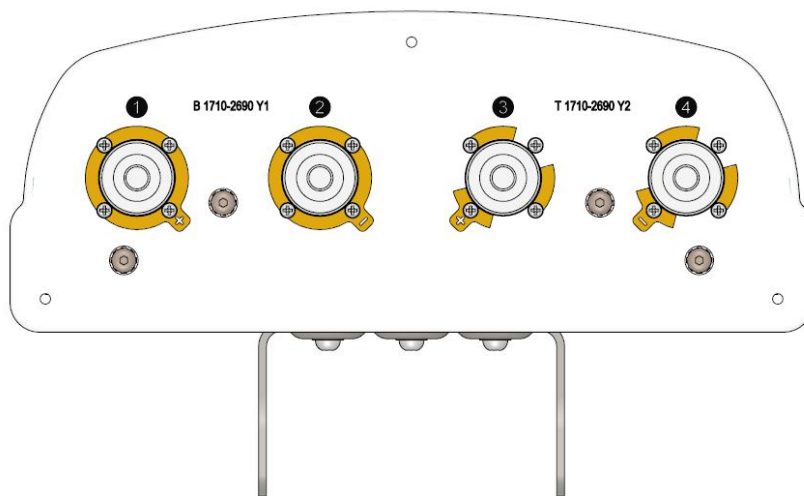

Correlation Table

Frequency range	Array	Connector
1710– 2690 MHz	Y1	1-2
1710– 2690 MHz	Y2	3-4

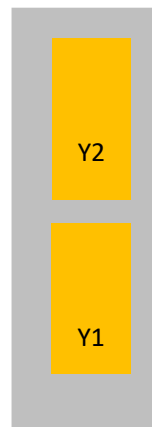

Product Data Sheet

LLPX207P-C

XX Pol Panel Antenna 2×1710-2690MHz 33° 19dBi 0°-10°Replaceable RET

Electrical Specifications

Frequency Range (MHz):	1710-2690(Y1,Y2)				
	1710-1880	1880-2025	2025-2170	2300-2500	2500-2690
Gain (dBi):	17.6±0.5	18.0±0.5	18.5±0.5	18.2±0.5	18.0±0.5
Return Loss (dB):	>14 (VSWR<1.5)				
Polarization:	±45°				
Horizontal 3dB beamwidth (°):	38	35	32	30	28
Vertical 3dB beamwidth (°):	9.5	9.0	8.5	8.0	7.5
Electrical Downtilt (°):	0°-10° Independently Continuously Adjustable				
RET Type:	RET Cascade SRET, AISG 2.0, Upgradeable				
1 st Upper Sidelobe Suppression (dB):	15				
Front to Back Ratio (dB):	25				
Cross Polar Ratio 0°(dB) :	15				
Cross Polar Ratio ±15°(dB) :	10				
Isolation Port to Port (dB):	28				
Max. Power Per Port (W):	200				
Intermodulation IM3 (dBc):	<-150 (2×43 dBm)				
Impedance (ohm):	50				
Lightning Protection:	DC Grounded				
Connector Type:	4×4.3-10 Female				

BASTA Electrical Specifications

Frequency Range(MHz):	1710-2690(Y1,Y2)				
	1710-1880	1880-2025	2025-2170	2300-2500	2500-2690
Average Gain by Beam Tilts (dBi):	0° 18.08	0° 18.23	0° 18.29	0° 18.30	0° 17.88
	5° 18.00	5° 18.06	5° 18.18	5° 18.13	5° 17.73
	10° 17.68	10° 17.76	10° 17.82	10° 17.70	10° 17.70
Gain by all Beam Tilts Tolerance(dB):	±0.32	±0.41	±0.40	±0.33	±0.53
Horizontal Beamwidth Tolerance(°):	±3.84	±1.16	±0.97	±0.76	±0.55
Vertical Beamwidth Tolerance(°):	±0.92	±0.37	±0.42	±0.26	±0.27
Upper Side Lobe Suppression, Peak to 20°(dB):	15.11	17.24	16.36	17.62	15.43
Front to back Total Power at 180° ± 30°(dB)	25.07	31.03	26.74	27.66	27.02
CPR at Boresight(dB):	16.61	19.44	18.67	19.05	18.88

Mechanical Data

Antenna Dimensions (mm):	940×504×118
Packing Dimensions (mm):	1210×590×215
Antenna Net Weight/Bracket (kg):	16 / 5.9
Antenna Gross Weight (kg):	24.5
Radome Material:	Fiberglass
Pipe OD (mm):	50-114
Mounting Kits (Included):	BA.K.04.00069161, Adjustable Downtilt 0°-30°

Environmental Ratings

Humidity:	95%RH@+30℃
Temperature (℃):	-40~+70
Wind Load @150 km/h (N):	Frontal/Lateral/Rearside: 773/64/817
Max. Wind velocity(km/h):	200

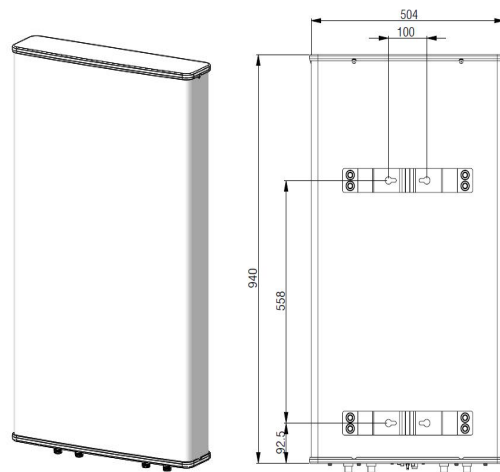

Product Data Sheet

LLPX207P-C

Internal RET Specifications

RET type:	Replaceable RET
RET protocol:	AISG 2.0 /3 GPP
Input voltage range (V):	10-30 DC
Power consumption (W):	< 5 (motor activated, single RET) < 1 (stand by, single RET), < 1.5 (stand by, 12V)
Adjustment time (full range):	< 120 (typically, depending on antenna type)
RET connector:	1 pair of AISG 5 pin male & female
Pin assignment according AISG:	8 pin circular connector conforming to IEC 60130-9 - Ed. 3.0
Lightning protection (kA):	5 (8/20 μ s Differential mode), 8 (8/20 μ s Common mode)

Typical Patterns

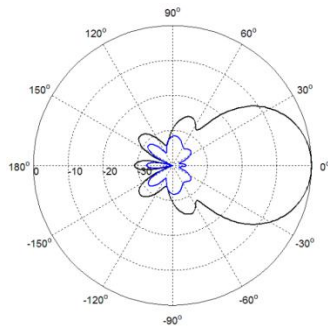

Azimuth

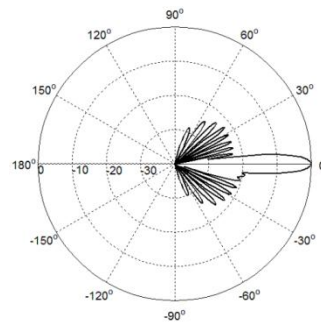

Elevation

Bottom View

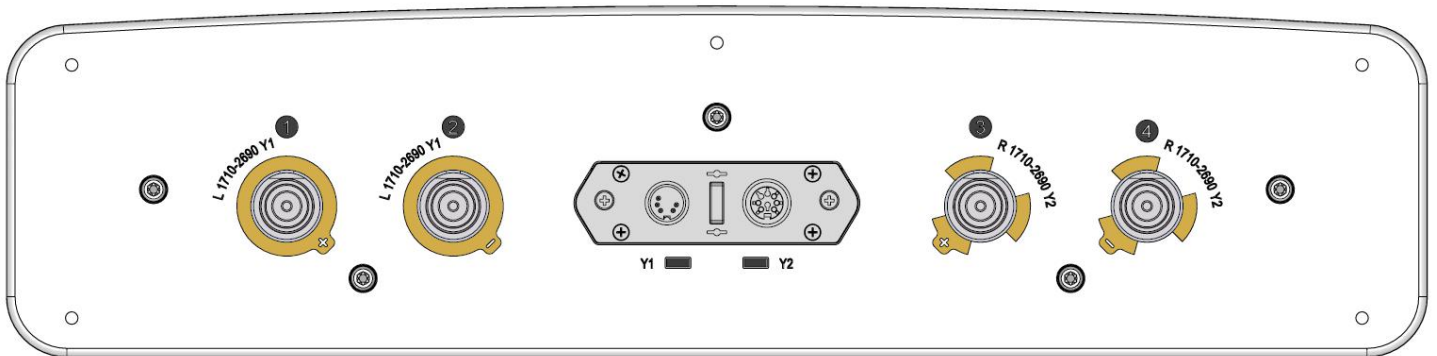

Correlation Table

Frequency range	Array	Connector	RET S/N
1710–2690 MHz	Y1	1-2	BRxxx.....1Y1
1710–2690 MHz	Y2	3-4	BRxxx.....2Y2

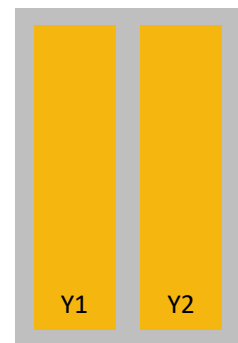

Product Data Sheet

LLPX303F6-C

XX Pol Panel Antenna 1710-2690/1710-2690MHz 65°/65° 12/12dBi 6° FET

Electrical Specifications

Frequency Range (MHz):	1710-1880	1880-2025	2025-2170	2300-2500	2500-2690
Gain (dBi):	11.0±0.5	11.2±0.5	11.5±0.5	11.8±0.5	12.0±0.5
Return Loss (dB):	>14 (VSWR<1.5)				
Polarization (°):	±45				
Horizontal 3dB Beamwidth (°):	68	66	65	64	62
Vertical 3dB Beamwidth (°):	27	24	22	19	18
Electrical Downtilt (°):	6				
Front to Back Ratio (dB):	≥23				
Cross Polar Ratio 0°(dB):	>15				
Cross Polar Ratio ±60°(dB):	>10				
Isolation Port to Port (dB):	≥25				
Power Rating (W):	150				
Intermodulation IM3 (dBc):	<-150 (2×43 dBm)				
Lightning Protection:	DC Grounded				
Connector Type:	4x4.3-10 Female				

BASTA Electrical Specifications

Frequency Range(MHz):	1710-1880	1880-2025	2025-2170	2300-2500	2500-2690
Average Gain by all Beam Tilts (dBi):	11.2	11.4	11.6	11.8	12.1
Gain by all Beam Tilts Tolerance(dB):	±0.58	±0.65	±0.38	±0.46	±0.61
Horizontal Beamwidth Tolerance(°):	±4.5	±5.2	±2.9	±3.6	±4.2
Vertical Beamwidth Tolerance(°):	±0.4	±0.75	±1.32	±0.54	±0.73
Front to back Total Power at 180° ± 30°(dB)	23.2	23.6	24.3	23.1	24.8
CPR at Boresight(dB):	18.7	18.5	18.9	18.6	18.5

Mechanical Data

Antenna Dimensions (mm):	360×280×90
Packing Dimensions (mm):	630×312×196
Antenna Net Weight/Bracket (kg):	3.4/2.6
Antenna Gross Weight (kg):	6.6
Radome Material:	Fiberglass
Pipe OD (mm):	60-100
Mounting Kits (Included):	BA.K.04.00033, horizontal adjustable -35°~+35°, vertical adjustable-45°~+45°

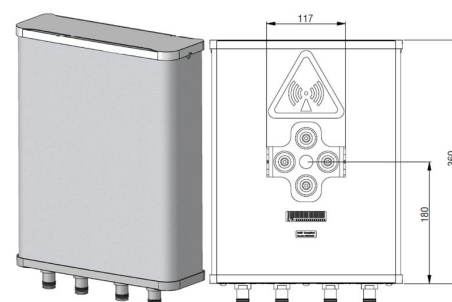

Environmental Ratings

Humidity:	95%RH@+30°C
Temperature (°C):	-50~+80
Wind Load @150 km/h (N):	Frontal/Lateral/Rearside: 162/21/184

LLPX303F6-C

Typical Patterns

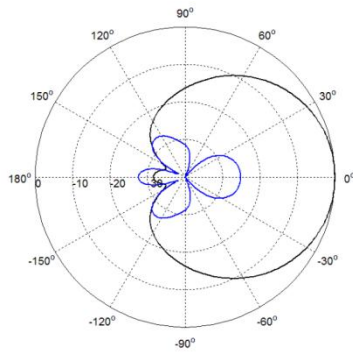

Azimuth

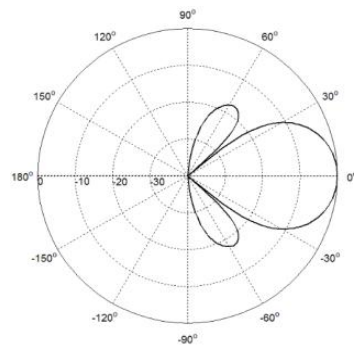

Elevation

Bottom View

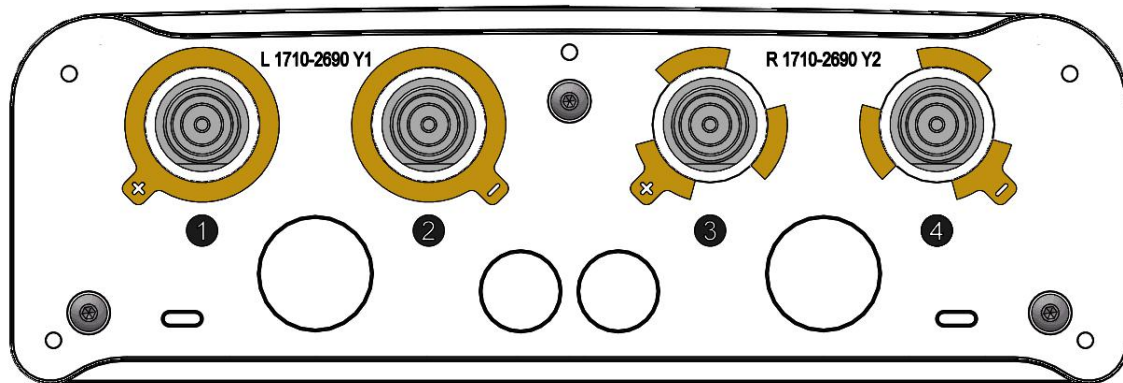

Correlation Table

Frequency range	Array	Connector
1710–2690 MHz	Y1	1-2
1710–2690 MHz	Y2	3-4

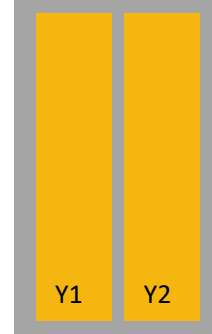

Product Data Sheet

LLPX306F0-C

XX Pol Panel Antenna 1710-2690/1710-2690MHz 65°/65° 15/15dBi 0° FET 4.3-10 Connector

Electrical Specifications

Frequency Range (MHz):	2×1710-2690(Y1,Y2)				
	1710-1880	1880-2025	2025-2170	2300-2500	2500-2690
Gain (dBi):	14.2±0.5	14.5±0.5	14.8±0.5	15.0±0.5	15.2±0.5
Return Loss (dB):	>14 (VSWR<1.5)				
Polarization (°):	±45				
Horizontal 3dB Beamwidth (°):	68	66	65	64	62
Vertical 3dB Beamwidth (°):	13.5	13.0	12.5	10.5	10
Electrical Downtilt (°):	0				
Front to Back Ratio (dB):	≥23				
Cross Polar Ratio 0°(dB):	>15				
Cross Polar Ratio ±60°(dB):	>10				
Isolation Port to Port (dB):	≥25				
Max. Power Per Port (W):	150				
Intermodulation IM3 (dBc):	<-150 (2×43 dBm)				
Lightning Protection:	DC Grounded				
Connector Type:	4×4.3-10 Female				

BASTA Electrical Specifications

Frequency Range(MHz):	2×1710-2690(Y1,Y2)				
	1710-1880	1880-2025	2025-2170	2300-2500	2500-2690
Average Gain by all Beam Tilts (dBi):	14.5	15.2	15.3	15.6	15.4
Gain by all Beam Tilts Tolerance(dB):	±0.18	±0.12	±0.35	±0.19	±0.41
Horizontal Beamwidth Tolerance(°):	±5.6	±3.5	±3.9	±3.7	±2.7
Vertical Beamwidth Tolerance(°):	±0.66	±0.72	±0.81	±0.75	±0.21
Front to back Total Power at 180° ± 30°(dB) :	25.6	25.4	25.0	28.6	26.1
CPR at Boresight(dB):	20.4	19.1	18.1	26.3	21.3

Mechanical Data

Antenna Dimensions (mm):	678×280×90
Packing Dimensions (mm):	1046×380×150
Antenna Net Weight/Bracket (kg):	5.9/5.7
Antenna Gross Weight (kg):	13.5
Radome Material:	Fiberglass
Pipe OD (mm):	60-100
Mounting Kits (Included):	BA.K.04.00011, Adjustable Downtilt 0-24°

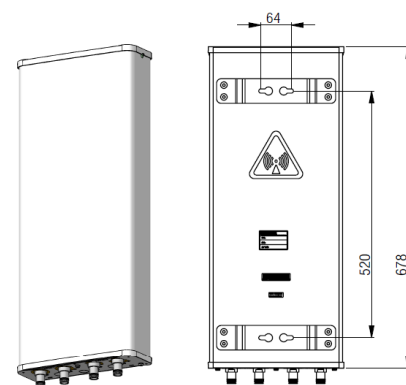

Environmental Ratings

Humidity:	95%RH@+30°C
Temperature (°C):	-40~+70
Wind Load @150 km/h (N):	Frontal/Lateral/Rearside: 313/42/357

LLPX306F0-C

Typical Patterns

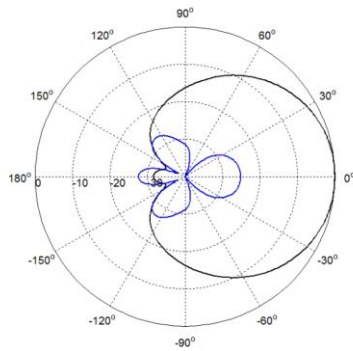

Azimuth

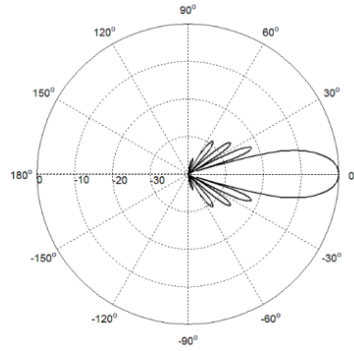

Elevation

Bottom View

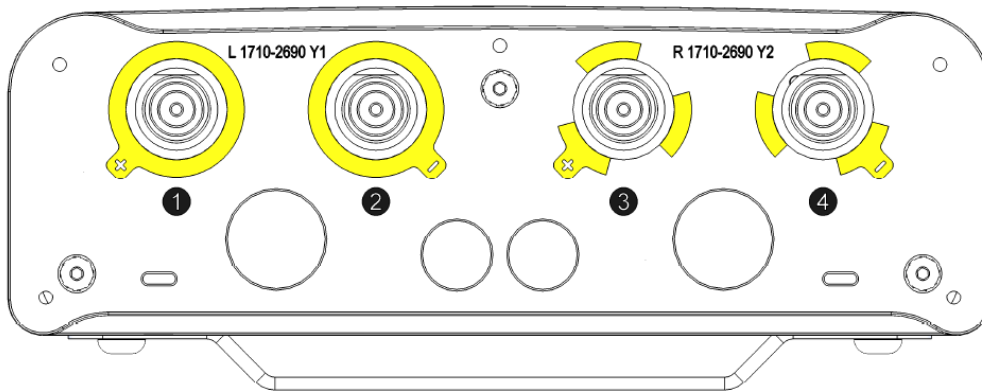

Correlation Table

Frequency range	Array	Connector
1710–2690 MHz	Y1	1-2
1710–2690 MHz	Y2	3-4

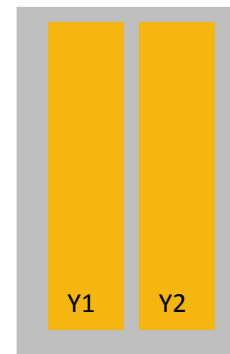

Product Data Sheet

LLPX306P-2C

XX Pol Panel Antenna 2×1710-2690MHz 65° 15dBi 2°-12° Replaceable RET

Electrical Specifications

Frequency Range (MHz):	2×1710-2690(Y1,Y2)		
	1710-2170	2300-2490	2490-2690
Gain (dBi):	13.8±0.5	14.5±0.5	14.8±0.5
Return Loss (dB):	>14 (VSWR<1.5)		
Polarization(°):	±45		
Horizontal 3dB Beamwidth (°):	68	63	58
Vertical 3dB Beamwidth (°):	15.5	12.5	11.5
Electrical Downtilt (°):	2-12 Independently Continuously Adjustable		
RET Type:	RET Cascade SRET, AISG 2.0, Upgradeable		
1 st Upper Sidelobe Suppression (dB):	15	15	15
Front to Back Ratio (dB):	>25	>25	>25
Cross Polar Ratio 0° (dB):	15	15	15
Cross Polar Ratio ±60° (dB):	>10	>8	>8
Isolation Port to Port(dB):	>25		
Impedance (ohm):	50		
Intermodulation IM3 (dBC):	<-150 (2×43dBm)		
Max. Power Per Port (W):	200		
Lightning Protection:	DC Grounded		
Connector Type:	4×4.3-10 Female		

BASTA Electrical Specifications

Frequency Range(MHz):	1710-2690(Y1,Y2)		
	1710-2170	2300-2490	2490-2690
Average Gain by Beam Tilts (dBi):	2° 14.02	2° 14.26	2° 14.46
	7° 13.85	7° 14.05	7° 14.18
	12° 13.57	12° 13.74	12° 13.93
Gain by all Beam Tilts Tolerance(dB):	±0.43	±0.50	±0.56
Horizontal BeamwidthTolerance(°):	±4.72	±5.11	±3.84
Vertical Beamwidth Tolerance(°):	±0.35	±0.24	±0.24
Upper Side Lobe Suppression, Peak to 20°(dB):	15.13	15.42	15.06
Front to back Total Power at 180° ± 30°(dB)	25.07	28.42	26.80
CPR at Boresight(dB):	20.14	17.56	18.38

Mechanical Data

Antenna Dimensions (mm):	695×280×90
Packing Dimensions (mm):	1015×365×185
Antenna Net Weight/Bracket (kg):	7.5/3.65
Antenna Gross Weight (kg):	13.5
Radome Material:	Fiberglass
Pipe OD (mm):	50-115
Mounting Kits (Included):	BA.K.04.00069501, Adjustable Downtilt 0°-30°

Environmental Ratings

Humidity:	95%RH@+30°C
Temperature (°C):	-40~+70
Wind Load @150 km/h (N):	Frontal/Lateral/Rearside: 245/39/279
Max.Wind velocity(km/h):	200

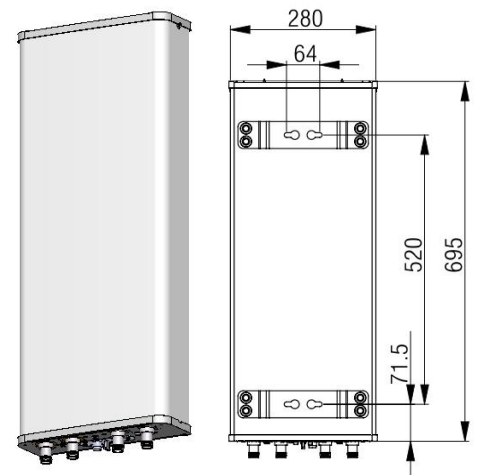

Product Data Sheet

LLPX306P-2C

Internal RET Specifications

RET type:	Replaceable RET
RET protocol:	AISG2.0 /3GPP
Input voltage range(V):	10-30 DC
Power consumption(W):	< 5 (motor activated, single RET) < 1 (standby, single RET), < 1.5 (standby, 12V)
Adjustment time (full range) (s):(s):	< 120 (typically, depending on antenna type)
RET connector:	1 pair of AISG 5 pin male & female
Pin assignment according AISG:	8 pin circular connector conforming to IEC 60130-9 - Ed. 3.0
Lightning protection (kA):	5 (8/20 μ s Differential mode), 8 (8/20 μ s Common mode)

Typical Patterns

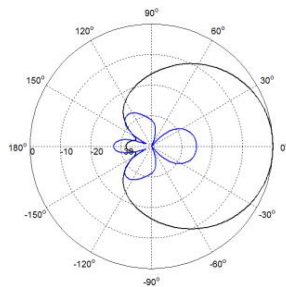

Azimuth

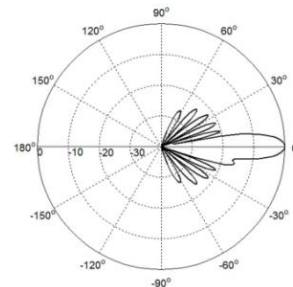

Elevation

Bottom View

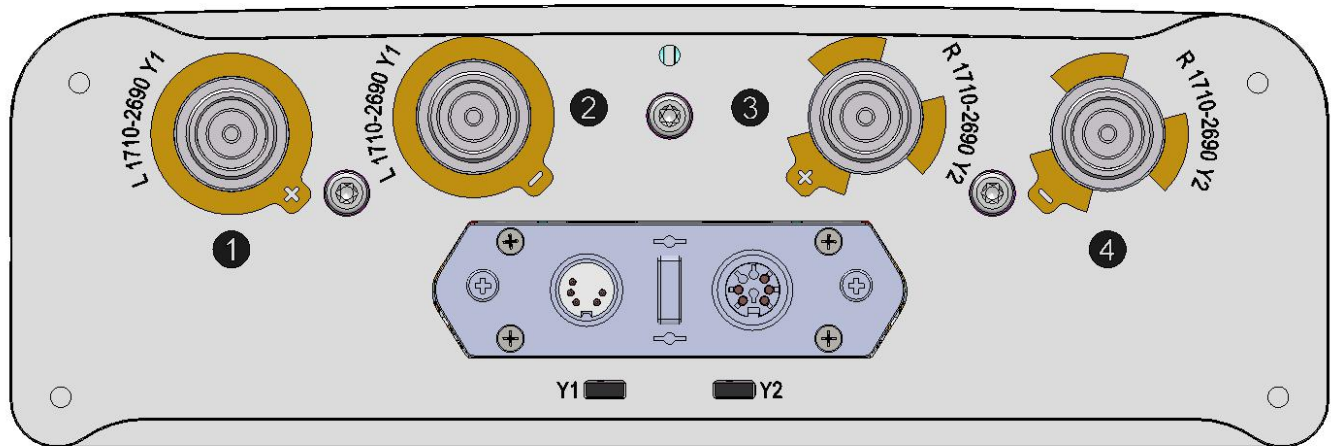

Correlation Table

Frequency range	Array	Connector	RET S/N
1710–2690 MHz	Y1	1-2	BRxxx.....1Y1
1710–2690 MHz	Y2	3-4	BRxxx.....2Y2

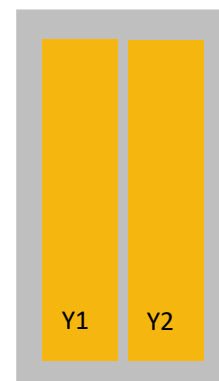

Product Data Sheet

LLPX310P-2C

XX Pol Panel Antenna 2×1710-2690MHz 65° 17dBi 2°-12°Replaceable RET

Electrical Specifications

Frequency Range (MHz):	2×1710-2690(Y1,Y2)		
	1710-2170	2300-2490	2490-2690
Gain (dBi):	16.3±0.5	16.8±0.5	17.0±0.5
Return Loss (dB):	>14 (VSWR<1.5)		
Polarization:	±45°		
Horizontal 3dB Beamwidth (°):	68	63	56
Vertical 3dB Beamwidth (°):	8.2	6.8	6.0
Electrical Downtilt (°):	2-12 Independently Continuously Adjustable		
RET Type:	RET Cascade SRET, AISG 2.0, Upgradeable		
Upper Sidelobe Suppression (dB):	15		
Front to Back Ratio (dB):	>25		
Cross Polar Ratio 0° (dB):	>17		
Isolation Port to Port(dB):	>28		
Impedance (ohm):	50		
Intermodulation IM3 (dBc):	<-150 (2×43dBm)		
Max. Power Per Port (W):	200		
Lightning Protection:	DC Grounded		
Connector Type:	4×4.3-10 Female		

BASTA Electrical Specifications

Frequency Range(MHz):	1710-2690(Y1,Y2)		
	1710-2170	2300-2490	2490-2690
Average Gain by Beam Tilts (dBi):	2° 16.45	2° 16.86	2° 16.74
	7° 16.23	7° 16.67	7° 16.42
	12° 15.94	12° 16.13	12° 16.05
Gain by all Beam Tilts Tolerance(dB):	±0.72	±0.92	±0.95
Horizontal Beamwidth Tolerance(°):	±3.94	±3.97	±4.01
Vertical Beamwidth Tolerance(°):	±1.08	±0.50	±0.26
Upper Side Lobe Suppression, Peak to 20°(dB):	15.15	15.32	15.55
Front to back Total Power at 180° ± 30°(dB)	25.66	25.52	25.23
CPR at Boresight(dB):	21.82	20.49	17.39

Mechanical Data

Antenna Dimensions (mm):	1280×280×90
Packing Dimensions (mm):	1600×365×185
Antenna Net Weight/Bracket (kg):	11/3.65
Antenna Gross Weight (kg):	19
Radome Material:	Fiberglass
Pipe OD (mm):	50-115
Mounting Kits (Included):	BA.K.04.00069421, Adjustable Downtilt 0°-16°

Environmental Ratings

Humidity:	95%RH@+30°C
Temperature (°C):	-40~+70
Wind Load @150 km/h (N):	Frontal/Lateral/Rearside: 463/76/527
Max. Wind velocity(km/h):	200

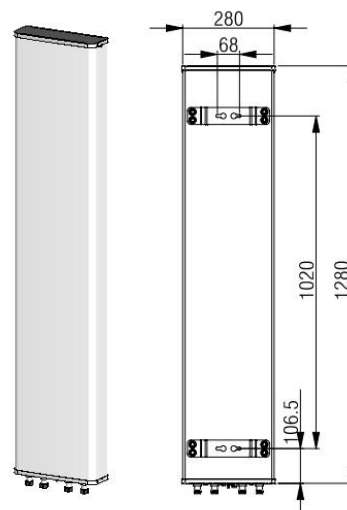

Product Data Sheet

LLPX310P-2C

Internal RET Specifications

RET type:	Replaceable RET
RET protocol:	AISG2.0 /3GPP
Input voltage range(V):	10-30 DC
Power consumption(W):	< 5 (motor activated, single RET) < 1 (standby, single RET), < 1.5 (standby, 12V)
Adjustment time (full range) (s):	< 120 (typically, depending on antenna type)
RET connector:	1 pair of AISG 5 pin male & female
Pin assignment according AISG:	8pin circular connector conforming to IEC 60130-9 - Ed. 3.0
Lightning protection (kA):	5 (8/20 μ s Differential mode), 8 (8/20 μ s Common mode)

Typical Patterns

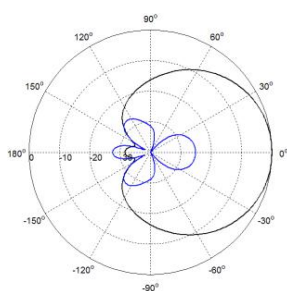

Azimuth

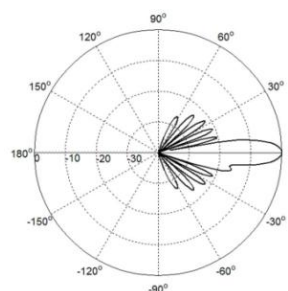

Elevation

Bottom View

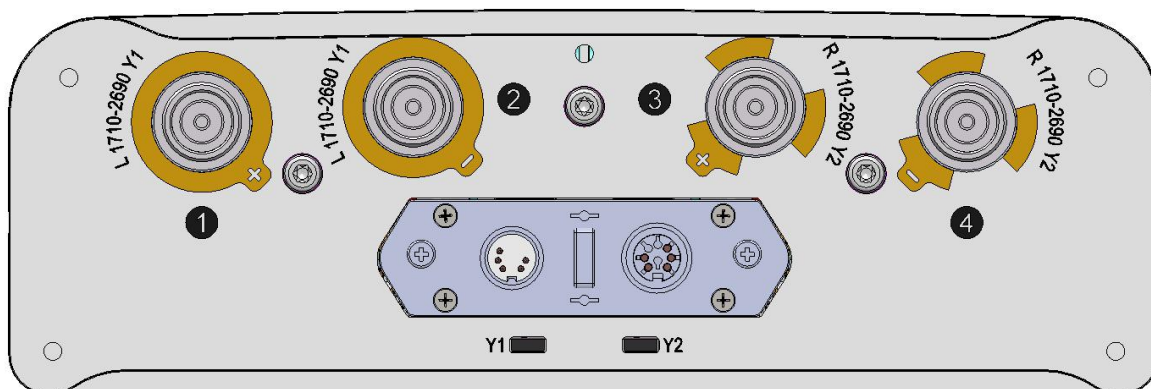

Correlation Table

Frequency range	Array	Connector	RET S/N
1710–2690 MHz	Y1	1-2	BRxxx.....1Y1
1710–2690 MHz	Y2	3-4	BRxxx.....2Y2

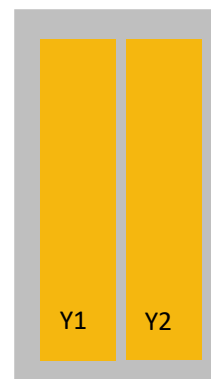

Product Data Sheet

LLPX314P-C

XX Pol Panel Antenna 2×1710-2690 65° 19dBi 0°-8° Replaceable RET

Electrical Specifications

Frequency Range (MHz):	2×1710-2690(Y1,Y2)		
	1710-2170	2300-2490	2490-2690
Gain (dBi):	17.8±0.5	18.7±0.5	19.0±0.5
Return Loss (dB):	>14 (VSWR<1.5)		
Polarization:	±45°		
Horizontal 3dB Beamwidth (°):	68	63	58
Vertical 3dB Beamwidth (°):	6.0	5.2	4.5
Electrical Downtilt (°):	0°-8° Independently Continuously Adjustable		
RET Type:	RET Cascade SRET, AISG 2.0, Upgradeable		
1 st Upper Sidelobe Suppression (dB):	15	15	15
Front to Back Ratio (dB):	>25	>25	>25
Cross Polar Ratio 0° (dB):	15	15	15
Cross Polar Ratio ±60° (dB):	10	9	8
Isolation Port to Port(dB):	>28		
Max. Power Per Port (W):	200		
Intermodulation IM3 (dBC):	<-150 (2×43dBm)		
Impedance (ohm):	50		
Lightning Protection:	DC Grounded		
Connector Type:	4×4.3-10 Female		

BASTA Electrical Specifications

Frequency Range(MHz):	1710-2690(Y1,Y2)		
	1710-2170	2300-2490	2490-2690
Average Gain by Beam Tilts (dBi):	0° 18.16	0° 18.41	0° 18.55
	4° 18.03	4° 18.26	4° 18.39
	8° 17.91	8° 18.08	8° 18.11
Gain by all Beam Tilts Tolerance(dB):	±0.33	±0.45	±0.50
Horizontal BeamwidthTolerance(°):	±2.76	±3.69	±4.08
Vertical Beamwidth Tolerance(°):	±0.54	±0.49	±0.34
Upper Side Lobe Suppression, Peak to 20°(dB):	15.11	15.09	15.32
Front to back Total Power at 180° ± 30°(dB)	25.70	30.66	28.96
CPR at Boresight(dB):	22.48	21.40	17.43

Mechanical Data

Antenna Dimensions (mm):	1700×280×90
Packing Dimensions (mm):	2015×345×165
Antenna Net Weight/Bracket (kg):	15.5/3.65
Antenna Gross Weight (kg):	23
Radome Material:	Fiberglass
Pipe OD (mm):	50-115
Mounting Kits (Included):	BA.K.04.00069411, Adjustable Downtilt 0°-12°

Environmental Ratings

Humidity:	95%RH@+30°C
Temperature (°C):	-40~+70
Wind Load @150 km/h (N):	Frontal/Lateral/Rearside: 830/121/945
Max.Wind velocity(km/h):	200

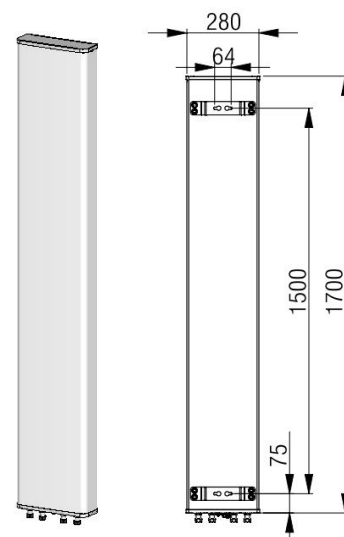

Product Data Sheet

LLPX314P-C

Internal RET Specifications

RET type:	Replaceable RET
RET protocol:	AISG2.0 /3GPP
Input voltage range(V):	10-30 DC
Power consumption(W):	< 5 (motor activated, single RET) < 1 (standby, single RET), < 1.5 (standby, 12V)
Adjustment time (full range) (s):(s):	< 120 (typically, depending on antenna type)
RET connector:	1 pair of AISG 5 pin male & female
Pin assignment according AISG:	8pin circular connector conforming to IEC 60130-9 - Ed. 3.0
Lightning protection (kA):	5 (8/20 μs Differential mode), 8 (8/20 μs Common mode)

Typical Patterns

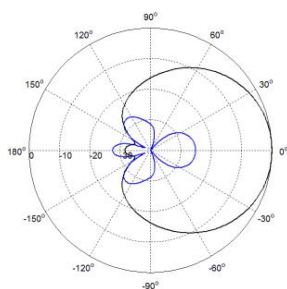

Azimuth

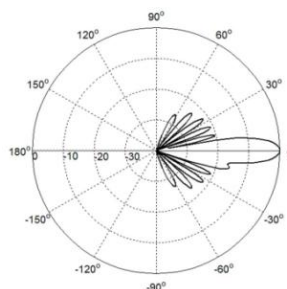

Elevation

Correlation Table

Frequency range	Array	Connector
1710–2690 MHz	Y1	1-2
1710–2690 MHz	Y2	3-4

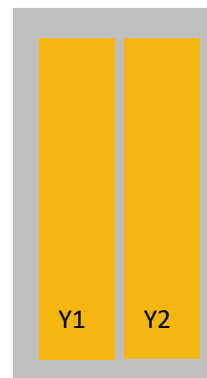

Product Data Sheet

VVPX202F0-V1

XX Pol Panel Antenna 3300-3800/3300-3800MHz 32°/32° 14/14dBi 0° FET

Electrical Specifications

Frequency Range (MHz):	3300-3800(P1)			3300-3800(P2)		
	3300-3400	3500-3600	3700-3800	3300-3400	3500-3600	3700-3800
Gain (dBi):	13.5	13.0	13.7	13.5	13.0	13.5
Return Loss (dB):	≥14(VSWR≤1.5)					
Polarization:	±45°					
Horizontal 3dB Beamwidth (°):	31	31	31	32	32	32
Vertical 3dB Beamwidth (°):	30	30	31	31	31	30
Front to Back Ratio (dB):	29	30	30	31	29	29
Isolation (dB):	≥25					
Impedance (ohm):	50					
Max. Power Per Port (W):	100					
Intermodulation IM3 (dBc):	<-150 (2×43 dBm)					
Lightning Protection:	DC Grounded					
Connector Type:	4×7/16 DIN Female					

BASTA Electrical Specification

Frequency Range (MHz):	3300-3800(P1)			3300-3800(P2)		
	3300-3400	3500-3600	3700-3800	3300-3400	3500-3600	3700-3800
Average Gain by all Beam Tilts (dBi):	13.5	13.0	13.7	13.5	13.0	13.5
Gain by all Beam Tilts Tolerance (dB):	±0.9	±0.8	±0.7	±0.9	±0.8	±0.8
3dB Horizontal Beamwidth Tolerance (°):	±2.5	±2.5	±2	±2.5	±2.5	±1.5
3dB Vertical Beamwidth Tolerance (°):	±2.5	±2.5	±2	±2	±2	±2
Horizontal Sidelobe Suppression (dB):	22	23	20	25	24	21
Vertical Sidelobe Suppression (dB):	21	22	20	24	22	20
Front to back Total Power at 180° ± 30° (dB):	27	28	27	28	27	27
CPR at Boresight (dB):	22	20	21	18	21	22

Mechanical Data

Antenna Dimensions (mm):	400×155×90
Packing Dimensions (mm):	830×224×210
Antenna Net Weight/Bracket (kg):	2.7/1.5
Antenna Gross Weight (kg):	5.5
Radome Material:	Fiberglass
Pipe OD (mm):	70-114
Mounting Kits (Included):	BA.K.04.00033, horizontal adjustable -35°-+35°, vertical adjustable-45°-+45°

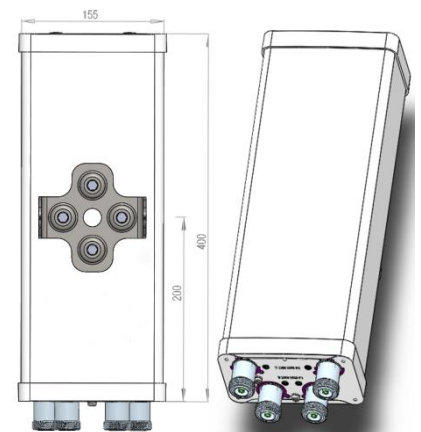

Environmental Ratings

Humidity:	95%RH@+30°C
Temperature (°C):	-40~+70
Wind Load @150 km/h (N):	Frontal/ Lateral/ Rearside: 91/53/101
Max. Wind velocity (km/h):	200

VVPX202F0-V1

Typical Patterns

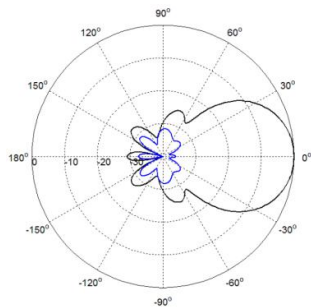

Azimuth

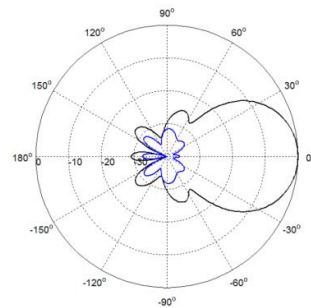

Elevation

Bottom View

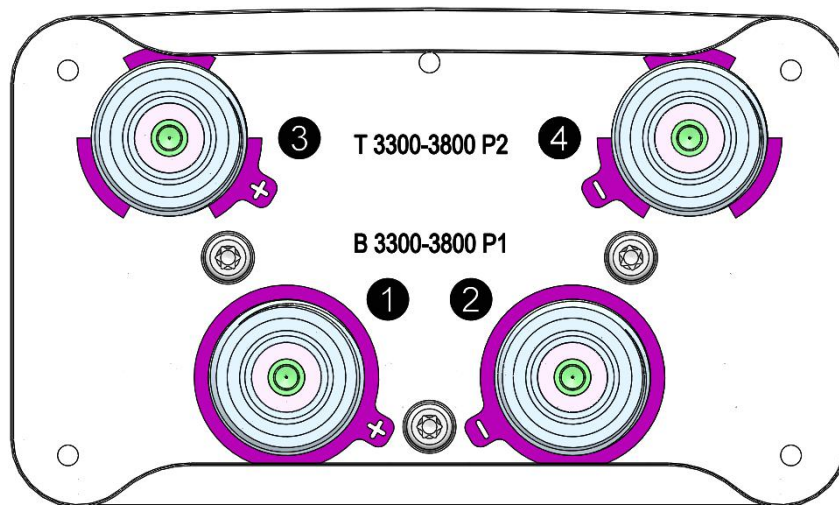

Correlation Table

Frequency range	Array	Connector
3300-3800 MHz	P1	1-2
3300-3800 MHz	P2	3-4

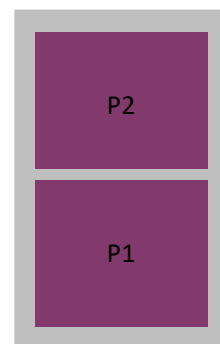

Multi-band Antennas

No.	Type	BR Part No.	Frequency(MHz)	HBW(deg)	Gain(dBi)	E-Tilt	Size mm(L*W*D)	Page
1	2 Ports	ULPX301.2F0-2P	698-960/1710-2690	65/65	8/11	0°/0° FET	300×300×150	52
2	2 Ports	ULPX301.2F0-2P-C	698-960/1710-2690	65/65	8/11	0°/0° FET	300×300×150	54
3	2 Ports	ULPX302.4F3-2P	698-960/1710-2690	65/65	10/13.5	3°/3° FET	495×300×150	56
4	2 Ports	ULPX302.4F3-2P-V1	698-960/1710-2690	65/65	10/13.5	3°/3° FET	495×300×150	58
5	2 Ports	ULPX302.4F3-2P-V1-C	698-960/1710-2690	65/65	10/13.5	3°/3° FET	495×300×150	60
6	4 Ports	ULPX302.4F3	698-960/1710-2690	65/65	10.5/14	3°/3° FET	495×300×150	62
7	4 Ports	ULPX302.4F3-V1	698-960/1710-2690	65/65	10.5/14	3°/3° FET	495×300×150	64
8	4 Ports	ULPX302.4F3-V1-C	698-960/1710-2690	65/65	10.5/14	3°/3° FET	495×300×150	66

9	2 Ports	ULPX305.10P-2P-C	698-960/1710-2690	65/65	14/17	0°-14°/0°-10° RET	1445×339×169	68
10	4 Ports	★ULPX309.12P-C	698-960/1710-2690	65/65	17/17.5	0°-10°/0°-10° RET	2495×339×169	71
11	2 Ports	LVPX203F0-2P	1710-2700/3300-3800	25/25	15	0°FET	750×448×145	73
12	4 Ports	LVPX203F0	1710-2700/3300-3800	25/25	15	0°FET	750×448×145	75
13	6 Ports	UL2PX205.10P-E2-C	698-960/2×1710-2690	33/33	16/20	2-12°/2-12° RET	1350×498×197	77
14	6 Ports	UL2PX302.4F3	698-960/2×1710-2690	65/65	10.5/15	3°FET	492×339×169	80
15	6 Ports	UL2PX302.4F3-C	698-960/2×1710-2690	65/65	10.5/15	3°FET	492×339×169	82
16	6 Ports	UL2PX303.6R-E5-C	698-960/1710-2690 /1710-2690	65/65/65	12/15/15	5-15°/5-15°/5-15° RET	881×339×169	84
17	6 Ports	★UL2PX305.10P-E2-C	698-960/2×1695-2690	65/65	14.5/17.5	2-15°/2-12° RET	1395×339×169	87
18	6 Ports	UL2PX306.12P-2C	698-960/2×1710-2690	65/65	15.5/18	2-12° RET	1795×339×169	89
19	6 Ports	UL2PX309.12P-V1-C	698-960/2×1710-2690	65/65	17/18	0°-10° RET	2495×339×169	91

20	6 Ports	U2LPX307.10P-E2-C	2×698-960/1710-2690	65/65	15.5/17.5	2-12°/2-12° RET	1820×448×185	93
21	6 Ports	U2LPX309.10P-E2-C	2×698-960/1710-2690	65/65	16.5/17	2-12°/2-12° RET	2250×448×185	95
22	4 Ports	LLVVPX201F0-4P-C	1710-2690/1710-2690/3300-3800/3300-3800	25	13.5/13.5/13/13	0°FET	600×300×110	97
23	4 Ports	LLVVPX203F0-4P-N	2×1710-2690/2×3300-3800	33/33	12/13	0°FET	540×420×110	99
24	4 Ports	ULVVPX201F0-4P	698-960/1710-2700/3300-3800/3300-3800	20	11/12/12/11.5	0°FET	806×460×135	101
25	6 Ports	ULVVPX201F0-6P	698-960/1710-2700/3300-3800/3300-3800	20	11/12/12/12	0°FET	806×460×135	103
26	8 Ports	UL2PX307.10P-DH-E2-C	694-960/1710-2170/2490-2690/1710-2690	65/65/65/65	16/16/17/18	2-12°/2-10°/2-10°/2-10° RET	1960×339×169	105
27	8 Ports	UL2PX307.12P-DL-C	698-862/880-960/2×1710-2690	65/65/65	16/16.5/18	2-12°/2-12°/2-10° RET	1995×396×190	108
28	8 Ports	ULLLPX305.10P-C	698-960/3×1710-2690	65/65	15/17.5	0°-14°/0°-10° RET	1380×396×190	111
29	8 Ports	ULLLPX307.10P-C	698-960/3×1710-2690	65/65	16/17.5	0-10°/0-10°RET	1820×396×190	114
30	8 Ports	ULLLPX307.12P-C	698-960/3×1710-2690	65/65	16/18	0-10°/0-10°RET	1995×396×190	117

31	8 Ports	ULLLPX309.12P-C	698-960/3×1710-2690	65/65	16.5/18	2-12°/0-10°RET	2495×396×190	120
32	8 Ports	UL3PX306.7P-C	694-960/2×1710-2690/ 1710-2690	65/65/65	15/16/15.5	0°-10°/0°-10°/0°-10° RET	1650×339×169	123
33	8 Ports	UL3PX307.8P-C-V1	694-960/2×1710-2690/ 1710-2690	65/65/65	16/16.5/16	0-10°/0-10°/0-10° RET	1960×339×169	126
34	8 Ports	UL3PX309.10P-C	698-960/2×1710-2690/ 1710-2690	65/65/65	17/17.5/17	0°-10°/0°-10°/0°-10° RET	2495×339×169	129
35	8 Ports	U2L2PX307.10P-E2-C	2×698-960/2×1710-2690	65/65	15.5/17	2-12°/2-12° RET	1820×448×185	132
36	8 Ports	U2L2PX309.10P-E2-C	2×698-960/2×1710-2690	65/65	17/17.5	2-12°/2-12° RET	2250×448×185	134
37	10 Ports	UL4PX306.7P-C	694-960/2×1710-2690/ 2×1710-2690	65/65/65	15/15.5/16	0°-10°/0°-10°/0°-10° RET	1650×339×169	136
38	10 Ports	UL4PX307.8P-C-V1	694-960/2×1710-2690/ 2×1710-2690	65/65/65	16/16.5/16	0-10°/0-10°/0-10° RET	1960×339×169	139
39	10 Ports	★U2L3PX307.10P-E2-C	2×698-960/3×1710-2690	65/65	16/17	2-12°/2-12° RET	1900×448×185	142
40	12 Ports	L2H2PX310P-DH2-2C	2×1710-2170/2×2500-2690/2× 2500-2690	65/65/65	16.5/17/17	2-12°/2-12°/2-12° RET	2200×320×140	144
41	12 Ports	U2L4PX305.10P-E2-C	2×698-960/4×1710-2690	65/65	14/17.5	2-12°/2-12° RET	1395×498×197	148

42	12 Ports	U2L4PX307.10P-2C	2×698-960/4×1710-2690	65/65	15.5/18	2-12°/2-12° RET	2000×498×197	150
43	12 Ports	U2L4PX309.10P-E2-C	2×698-960/4×1710-2690	65/65	17/17.5	2-12°/2-12° RET	2630×448×185	153
44	12 Ports	U2L2PX307.10P-DHH-C	2×698-960/2×1710-2170/2×2490-2690	65/65/65	15.5/16/16.5	0-10° RET	1995×448×185	155
45	14 Ports	★U2L3PX307.10P-DHH-E2-C	2×694-960/1710-2690/2×1710-2170/2×2490-2690	65/65/65/65	16/17.5/16/17	2-12° RET	1900×448×185	158
46	16 Ports	U2L4PX305.10P-DHH-2C	2×694-960/2×1710-2170/2×2490-2690/2×1710-2690	65/65/65/65	13/16.5/17/16.5	2-16°/2-12°/2-12°/2-12° RET	1495×498×197	160
47	16 Ports	U2L4PX308.10P-DH2-2C	2×698-960/2×1710-2170/2×2490-2690/2×1710-2690	65/65/65/65	15/16/16/17	2-12°/2-12°/2-12°/2-12° RET	1995×498×197	163
48	16 Ports	U2L6PX310P-2C	2×698-960/6×1710-2690	65/65	16.5/17	2-12° RET	2595×448×185	166
49	16 Ports	U2CL4PX310P2-DL-E2-C	698-862/880-960/698-960/1427-2690/4×1710-2690	65/65/65/65/65	15.5/16/16.5/16.5/17	2-12° RET	2595×448×185	168
50	20 Ports	★U2L8PX310P-E2-C	2×698-960/8×1710-2690	65/65	16/17.5	2-12° RET	2675×498×197	171
51	20 Ports	★U2C2L6PX310P2-DLL-2C	2×698-862/2×880-960/2×1427-2690/6×1710-2690	65/65/65/65	14.5/15/17/17.5	2-12° RET	2695×498×197	175

★ denotes the preliminary issued antenna

Product Data Sheet

ULPX301.2F0-2P

XX Pol Panel Antenna Built-in Diplexer 698-960/1710-2690MHz 65°/65° 8/11dBi 0°/0° FET

Electrical Specifications

Frequency Range (MHz):	698-960			1710-2690		
	698-806	806-880	880-960	1710-1920	1920-2170	2490-2690
Gain (dBi):	7.2±0.5	7.3±0.5	7.4±0.5	9.4±0.5	10.2±0.5	11.1±0.5
Return Loss (dB):	>14 (VSWR<1.5)					
Polarization (°):	±45					
Horizontal 3dB beamwidth (°):	70	68	67	70	65	58
Vertical 3dB beamwidth (°):	75	75	75	38	32	25
Electrical Downtilt (°):	0 Fixed					
1 st Upper Sidelobe Suppression(dB):	15					
Front to Back Ratio @180±30°(dB):	19	20	20	21	21	21
Cross Polar Ratio 0° (dB):	15					
Cross Polar Ratio ±30° (dB):	11.0	10.0	7.5	7.0	6.0	0.0
Isolation Port to Port (dB):	>25					
Power Rating (W):	100			100		
Intermodulation IM3 (dBc):	<-150 (2×43 dBm)					
Impedance (ohm):	50					
Lightning Protection:	DC Grounded					
Connector Type:	2×7/16 DIN Female					

BASTA Electrical Specifications

Frequency Range(MHz):	698-806	806-880	880-960	1710-1920	1920-2170	2490-2690
Average Gain by all Beam Tilts (dBi):	7.2	7.3	7.4	9.4	10.2	11.1
Gain by all Beam Tilts Tolerance(dB):	0.5	0.5	0.5	1.0	0.5	0.5
Average Gain by Beam Tilt (dBi):	7.2	7.3	7.4	9.4	10.2	11.1
Horizontal Beamwidth Tolerance(°):	5.0	4.0	4.0	10.0	10.0	5.0
Vertical Beamwidth Tolerance(°):	9.0	9.0	3.0	3.5	3.5	2.0
USLS beampeak to 20° above beampeak(dB):	22.0	18.0	18.0	18.0	19.0	19.0
Front to back Total Power at 180° ± 30°(dB):	19.0	20.0	20.5	21.5	21.5	21.5
CPR at Boresight(dB):	17.0	19.5	20.0	19.0	20.0	21.0
CPR at Sector(dB):	11.0	10.0	7.5	7.0	6.0	0.0

Mechanical Data

Antenna Dimensions (mm):	300×300×150
Packing Dimensions (mm):	507×420×253
Antenna Net Weight (kg):	3.51
Antenna Gross Weight (kg):	6.95
Radome Material:	PVC,UV Resistant
Pipe OD (mm):	70-114
Mounting Kits (Included):	BA.K.04.00033, horizontal adjustable -35°~+35°, vertical adjustable -45°~+45°

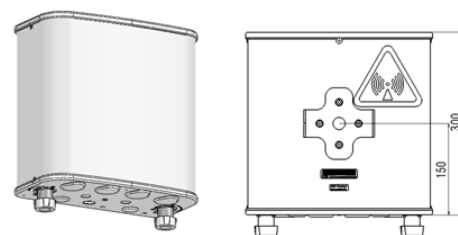

Environmental Ratings

Humidity:	95%RH@+30°C
Temperature (°C):	-40~+70
Wind Load @150 km/h (N):	Frontal/Lateral/Rearside: 142/40/178
Max.Wind velocity(km/h):	200

Product Data Sheet

ULPX301.2F0-2P

Typical Patterns

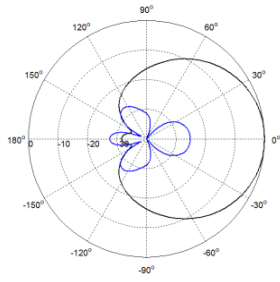

Azimuth(Low Band)

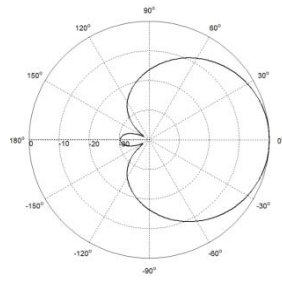

Elevation(Low Band)

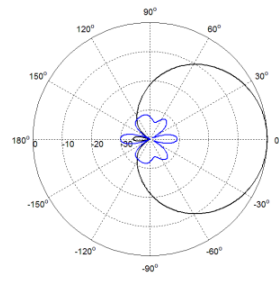

Azimuth(High Band)

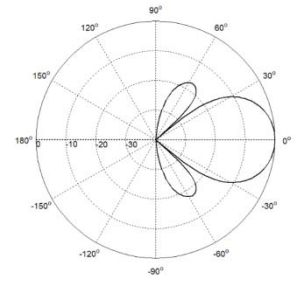

Elevation(High Band)

Bottom View

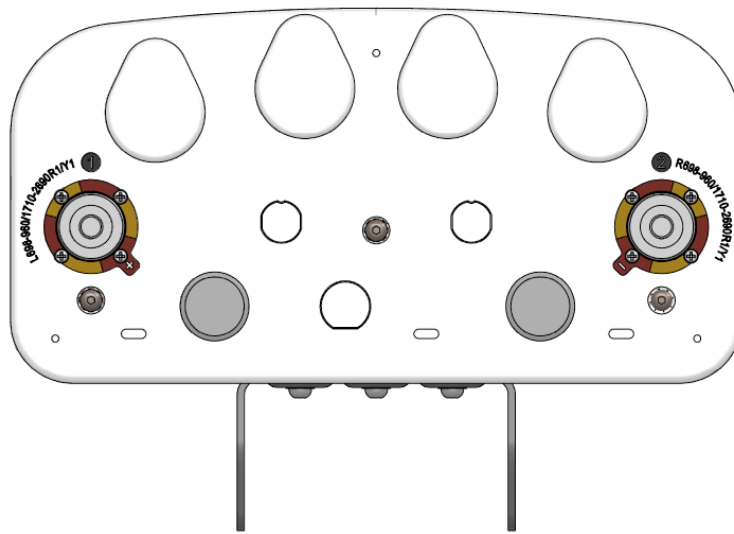

Correlation Table

Frequency range	Array	Connector
698–960 MHz	R1	1-2
1710– 2690 MHz	Y1	1-2

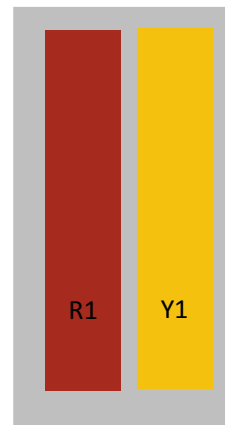

Product Data Sheet

ULPX301.2F0-2P-C

XX Pol Panel Antenna Built-in Diplexer 698-960/1710-2690MHz 65°/65° 8/11dBi 0°/0° FET

Electrical Specifications

Frequency Range (MHz):	698-960			1710-2690		
	698-806	806-880	880-960	1710-1920	1920-2170	2490-2690
Gain (dBi):	7.2±0.5	7.3±0.5	7.4±0.5	9.4±0.5	10.2±0.5	11.1±0.5
Return Loss (dB):	>14 (VSWR<1.5)					
Polarization:	±45°					
Horizontal 3dB beamwidth (°):	70	68	65	70	65	58
Vertical 3dB beamwidth (°):	75	67	75	38	32	25
Electrical Downtilt (°):	0 Fixed					
1 st Upper Sidelobe Suppression (dB):	15					
Front to Back Ratio @180±30°(dB):	19	20	20	21	21	21
Cross Polar Ratio 0° (dB):	15					
Cross Polar Ratio ±30° (dB):	11.0	10.0	7.5	7.0	6.0	0.0
Isolation Port to Port (dB):	>25					
Max. Power Per Port (W):	150			150		
Intermodulation IM3 (dBc):	<-150 (2×43 dBm)					
Impedance (ohm):	50					
Lightning Protection:	DC Grounded					
Connector Type:	2×4.3-10 Female					

BASTA Electrical Specifications

Frequency Range(MHz):	698-806	806-880	880-960	1710-1920	1920-2170	2490-2690
Average Gain by all Beam Tilts (dBi):	7.2	7.3	7.4	9.4	10.2	11.1
Gain by all Beam Tilts Tolerance(dB):	0.5	0.5	0.5	1.0	0.5	0.5
Average Gain by Beam Tilt (dBi):	7.2	7.3	7.4	9.4	10.2	11.1
Horizontal Beamwidth Tolerance(°):	5.0	4.0	4.0	10.0	10.0	5.0
Vertical Beamwidth Tolerance(°):	9.0	9.0	3.0	3.5	3.5	2.0
USLS beampeak to 20° above beampeak(dB):	22.0	18.0	18.0	18.0	19.0	19.0
Front to back Total Power at 180° ±30°(dB):	19.0	20.0	20.5	21.5	21.5	21.5
CPR at Boresight(dB):	17.0	19.5	20.0	19.0	20.0	21.0
CPR at Sector(dB):	11.0	10.0	7.5	7.0	6.0	0.0

Mechanical Data

Antenna Dimensions (mm):	300×300×150
Packing Dimensions (mm):	507×420×253
Antenna Net Weight (kg):	3.51
Antenna Gross Weight (kg):	6.95
Radome Material:	PVC,UV Resistant
Pipe OD (mm):	70-100
Mounting Kits (Included):	BA.K.04.00033, horizontal adjustable -35°-+35°, vertical adjustable-45°-+45°

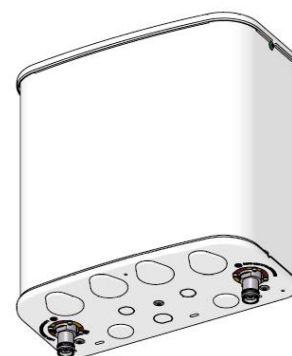

Environmental Ratings

Humidity:	95%RH@+30°C
Temperature (°C):	-40~+70
Wind Load @150 km/h (N):	Frontal/ Lateral/ Rearside:121/34/151
Max.Wind velocity(km/h)	200

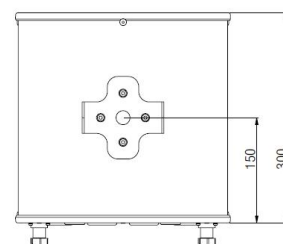

ULPX301.2F0-2P-C

Typical Patterns

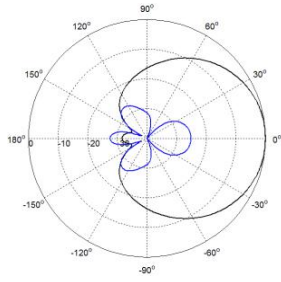

Azimuth(Low band)

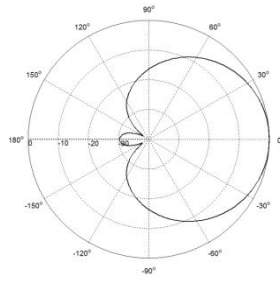

Elevation(Low band)

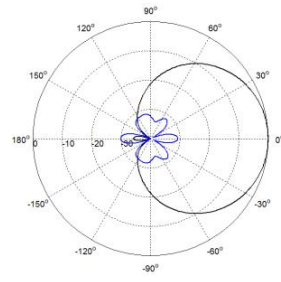

Azimuth(High band)

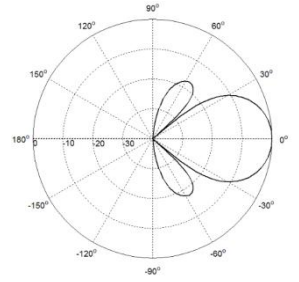

Elevation(High band)

Bottom View

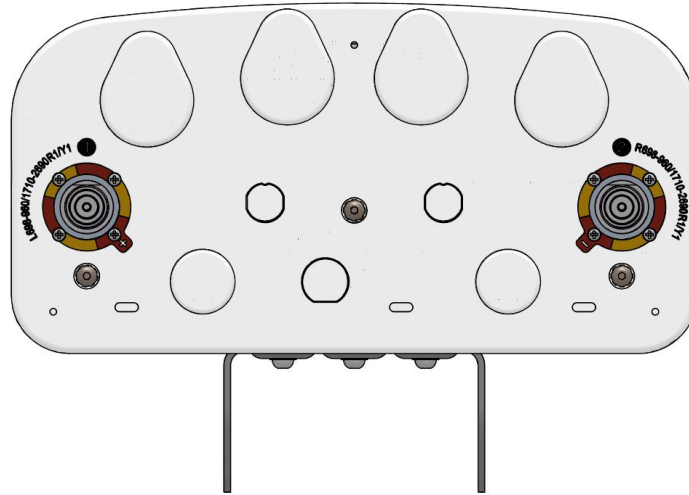

Correlation Table

Frequency range	Array	Connector
698–960 MHz	R1	1-2
1710–2690 MHz	Y1	1-2

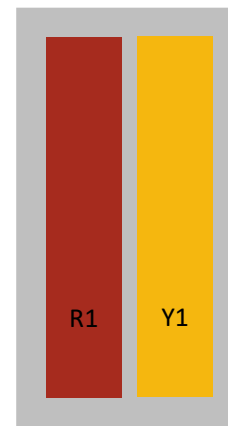

Product Data Sheet

ULPX302.4F3-2P

X Pol Panel Antenna Diplexed 698-960/1710-2690MHz 65°/65° 10/13.5dBi 3°/3° FET

Electrical Specifications

Frequency Range (MHz):	698-960			1710-2690		
	698-806	806-880	880-960	1710-1920	1920-2170	2490-2690
Gain (dBi):	9.5	9.5	9.8	12.0	13.0	14.5
Return Loss (dB):	>14(VSWR<1.5)					
Polarization:	±45°					
Horizontal 3dB Beamwidth (°):	72	75	72	72	68	58
Vertical 3dB Beamwidth (°):	42	38	33	21	18	15
Electrical Downtilt (°):	3 Fixed			3 Fixed		
1 st Upper Sidelobe Suppression (dB):	14	12	8	18	17	16
Front to Back Ratio (dB):	23	23	23	23	23	23
Cross Polar Ratio 0° (dB):	15	15	15	15	15	15
Cross Polar Ratio ±60° (dB):	12	10	8	10	8	5
Isolation Port to Port (dB):	>25					
Power Rating (W):	150			150		
Intermodulation IM3 (dBc):	<-150(2×43 dBm)					
Impedance (ohm):	50					
Lightning Protection:	DC Grounded					
Connector Type:	2×7/16 DIN Female					

Mechanical Data

Antenna Dimensions (mm):	495×300×150
Packing Dimensions (mm):	720×420×252
Antenna Net Weight (kg):	5.5
Antenna Gross Weight (kg):	9
Radome Material:	PVC, UV Resistant
Pipe OD (mm):	30-50
Mounting Kits (Included):	BA.K.04.00040, horizontal adjustable -35°~+35°, vertical adjustable -45°~+45°

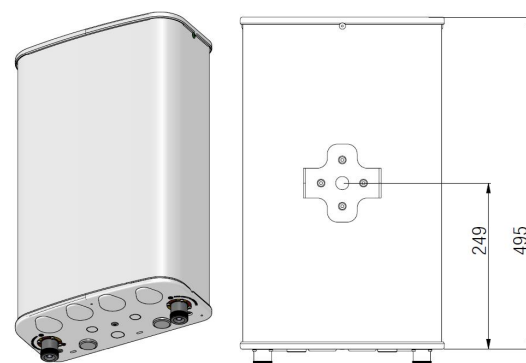

Environmental Ratings

Humidity:	95%RH@+30°C
Temperature (°C):	-40~+70
Wind Load @150 km/h (N):	Frontal/Lateral/Rearside: 203/58/255
Max. Wind velocity(km/h):	200

Typical Patterns

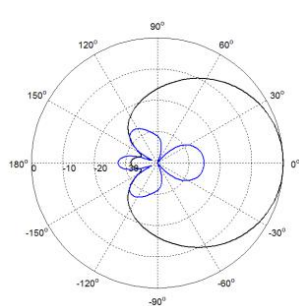

Azimuth(Low band)

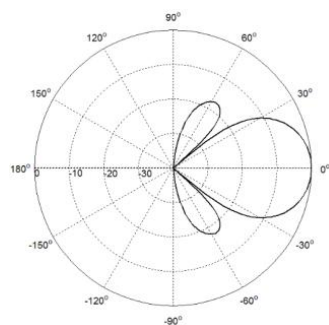

Elevation(Low band)

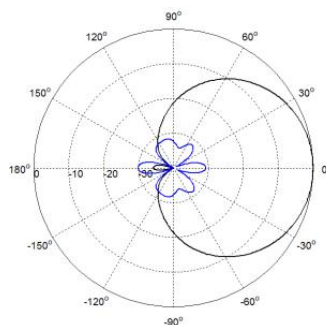

Azimuth(High band)

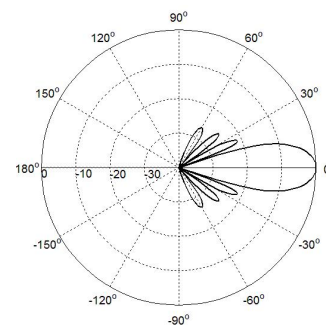

Elevation(High band)

ULPX302.4F3-2P

Bottom View

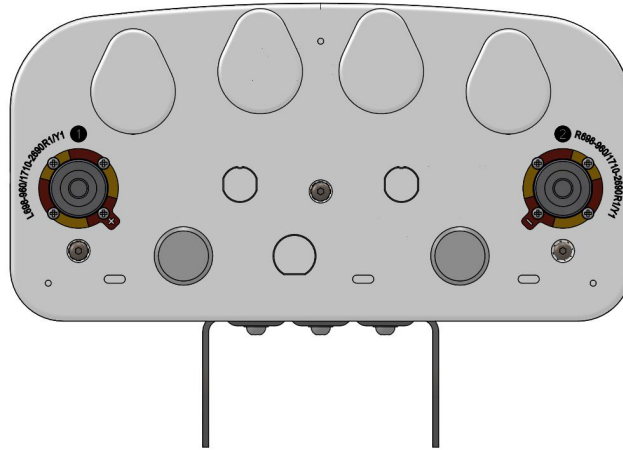

Correlation Table

Frequency range	Array	Connector
698–960 MHz	R1	1-2
1710–2690 MHz	Y1	1-2

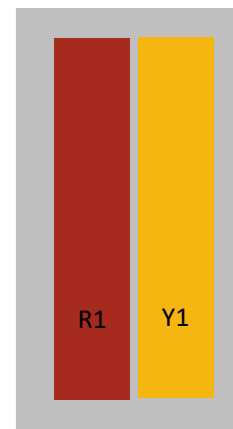

Product Data Sheet

ULPX302.4F3-2P-V1

XX Pol Panel Antenna Diplexed 698-960/1710-2690MHz 65°/65° 10/13.5dBi 3°/3° FET

Electrical Specifications

Frequency Range (MHz):	698-960(R1)			1710-2690(Y1)		
	698-806	806-880	880-960	1710-1920	1920-2170	2490-2690
Gain (dBi):	9.5±0.5	9.5±0.5	9.8±0.5	12.0±0.5	13.0±0.5	14.5±0.5
Return Loss (dB):	>14(VSWR<1.5)					
Polarization (°):	±45					
Horizontal 3dB Beamwidth (°):	72	75	72	72	68	58
Vertical 3dB Beamwidth (°):	42	38	33	21	18	15
Electrical Downtilt (°):	3 Fixed			3 Fixed		
1 st Upper Sidelobe Suppression (dB):	14	12	8	18	17	16
Front to Back Ratio (dB):	23	23	23	23	23	23
Cross Polar Ratio 0° (dB):	15	15	15	15	15	15
Cross Polar Ratio ±60° (dB):	12	10	8	10	8	5
Isolation Port to Port (dB):	>25					
Max. Power Per Port (W):	150			150		
Intermodulation IM3 (dBc):	<-150(2×43 dBm)					
Impedance (ohm):	50					
Lightning Protection:	DC Grounded					
Connector Type:	2×7/16 DIN Female					

Mechanical Data

Antenna Dimensions (mm):	495×300×150
Packing Dimensions (mm):	710×380×240
Antenna Net Weight (kg):	6
Antenna Gross Weight (kg):	10
Radome Material:	PVC, UV Resistant
Pipe OD (mm):	30-50
Mounting Kits (Included):	BA.K.04.00047, Support Pole installation , Wall mounted installation

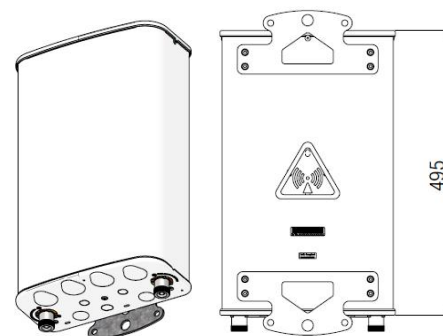

Environmental Ratings

Humidity:	95%RH@+30°C
Temperature (°C):	-40~+70
Wind Load @150 km/h (N):	Frontal/ Lateral/ Rearside: 203/58/255
Max. Wind velocity(km/h):	200

Typical Patterns

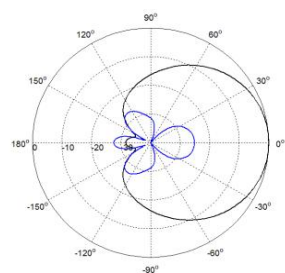

Azimuth(Low band)

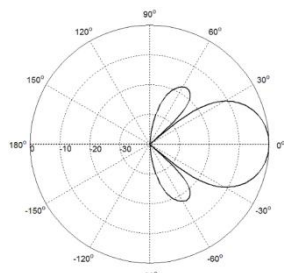

Elevation(Low band)

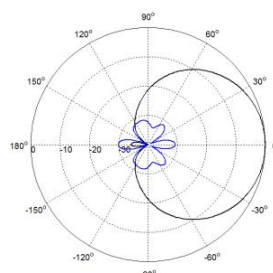

Azimuth(High band)

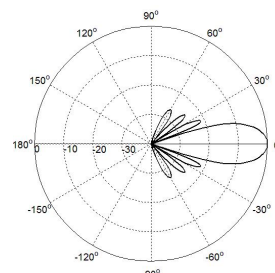

Elevation(High band)

ULPX302.4F3-2P-V1

Bottom View

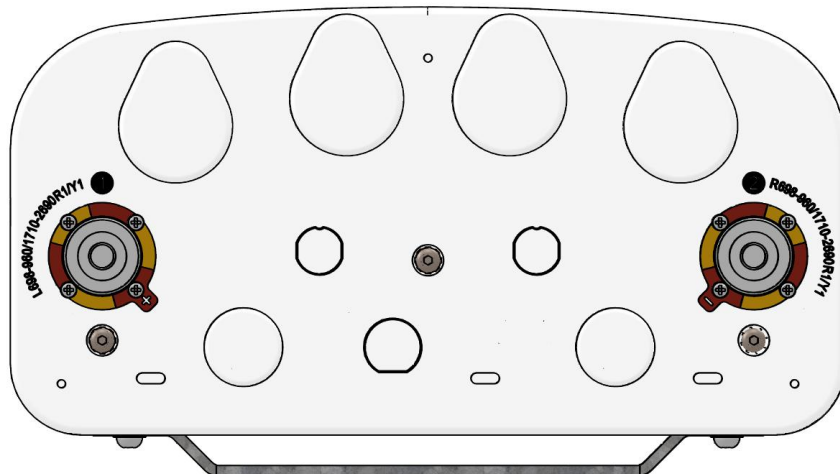

Correlation Table

Frequency range	Array	Connector
698–960 MHz	R1	1-2
1710– 2690 MHz	Y1	1-2

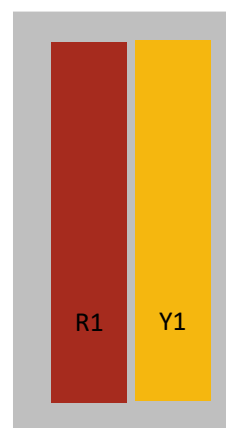

ULPX302.4F3-2P-V1-C

XX Pol Panel Antenna Diplexed 698-960/1710-2690MHz 65°/65° 10/13.5dBi 3°/3° FET

Electrical Specifications

Frequency Range (MHz):	698-960(R1)			1710-2690(Y1)		
	698-806	806-880	880-960	1710-1920	1920-2170	2490-2690
Gain (dBi):	9.5±0.5	9.5±0.5	9.8±0.5	12.0±0.5	13.0±0.5	14.5±0.5
Return Loss (dB):	>14(VSWR<1.5)					
Polarization:	±45°					
Horizontal 3dB Beamwidth (°):	72	75	72	72	68	58
Vertical 3dB Beamwidth (°):	42	38	33	21	18	15
Electrical Downtilt (°):	3					
1 st Upper Sidelobe Suppression (dB):	14	12	8	18	17	16+
Front to Back Ratio (dB):	23	23	23	23	23	23
Cross Polar Ratio 0° (dB):	15	15	15	15	15	15
Cross Polar Ratio ±60° (dB):	12	10	8	10	8	5
Isolation Port to Port (dB):	>25					
Intermodulation IM3 (dBc):	<-150 (2×43 dBm)					
Max. Power Per Port (W):	150			150		
Impedance (ohm):	50					
Lightning Protection:	DC Grounded					
Connector Type:	4.3-10 DIN Female					

Mechanical Data

Antenna Dimensions (mm):	495×300×150
Packing Dimensions (mm):	710×380×240
Antenna Net Weight (kg):	6
Antenna Gross Weight (kg):	10
Radome Material:	PVC,UV Resistant
Pipe OD (mm):	30-50
Mounting Kits (Included):	BA.K.04.00047, Support Pole installation, Wall mounted installation

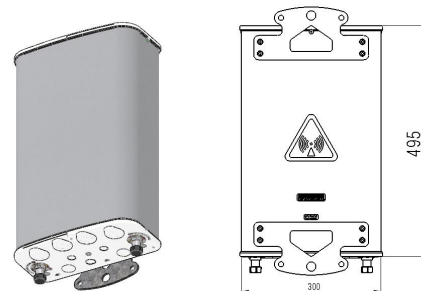

Environmental Ratings

Humidity:	95%RH@+30°C
Temperature (°C):	-40~+70
Wind Load @150 km/h (N):	Frontal/Lateral/Rearside: 203/58/255
Max. Wind velocity (km/h)	200

Typical Patterns

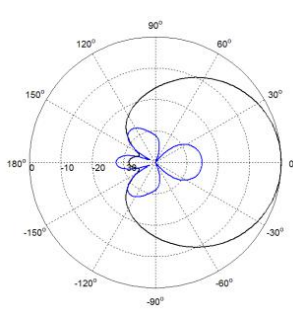

Azimuth(Low band)

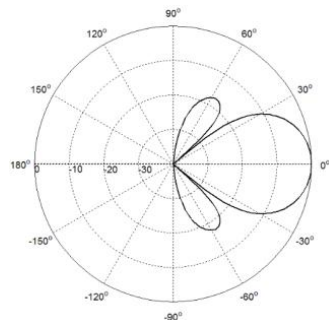

Elevation(Low band)

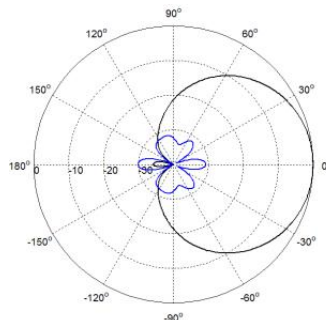

Azimuth(High band)

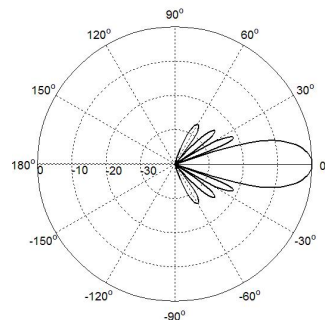

Elevation(High band)

ULPX302.4F3-2P-V1-C

Bottom View

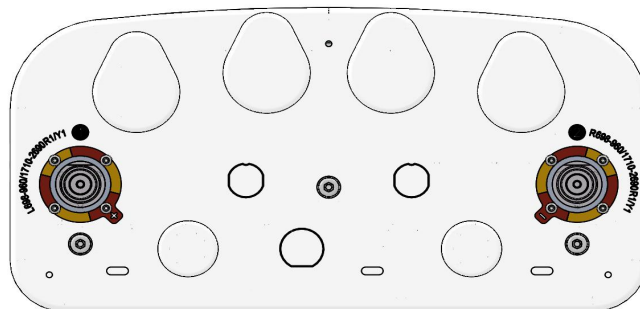

Correlation Table

Frequency range	Array	Connector
698-960MHz	R1	1-2
1710-2690MHz	Y1	1-2

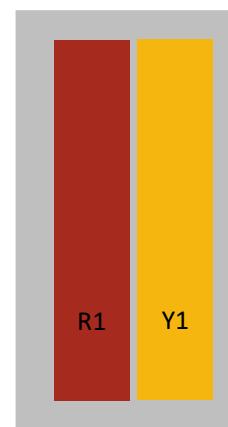

Product Data Sheet

ULPX302.4F3

XX Pol Panel Antenna Diplexed 698-960/1710-2690MHz 65°/65° 10.5/14dBi 3°/3° FET

Electrical Specifications

Frequency Range (MHz):	698-960			1710-2690		
	698-806	806-880	880-960	1710-1920	1920-2170	2490-2690
Gain (dBi):	10.0±0.5	9.7±0.5	10.5±0.5	12.5±0.5	13.5±0.5	15.0±0.5
Return Loss (dB):	>14(VSWR<1.5)					
Polarization:	±45°					
Horizontal 3dB Beamwidth (°):	72	75	72	72	68	58
Vertical 3dB Beamwidth (°):	42	38	33	21	18	15
Electrical Downtilt (°):	3 Fixed			3 Fixed		
1 st Upper Sidelobe Suppression (dB):	14	12	8	18	17	16
Front to Back Ratio (dB):	23	23	23	23	23	23
Cross Polar Ratio 0° (dB):	15	15	15	15	15	15
Cross Polar Ratio ±60° (dB):	12	10	8	10	8	5
Isolation Port to Port (dB):	>25					
Max. Power Per Port (W):	150			150		
Intermodulation IM3 (dBc):	<-150(2×43 dBm)					
Impedance (ohm):	50					
Lightning Protection:	DC Grounded					
Connector Type:	4×7/16 DIN Female					

Mechanical Data

Antenna Dimensions (mm):	495×300×150
Packing Dimensions (mm):	720×420×252
Antenna Net Weight (kg):	5.5
Antenna Gross Weight (kg):	9
Radome Material:	PVC, UV Resistant
Pipe OD (mm):	30-50
Mounting Kits (Included):	BA.K.04.00040, horizontal adjustable -35°-+35°, vertical adjustable-45°-+45°

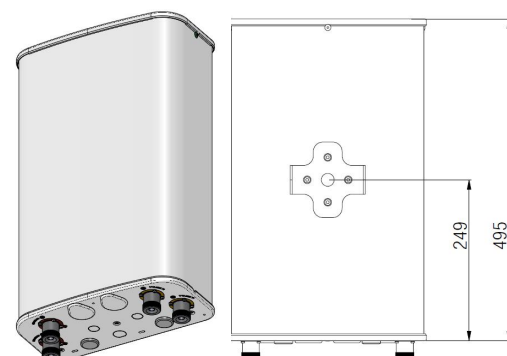

Environmental Ratings

Humidity:	95%RH@+30°C
Temperature (°C):	-40~+70
Wind Load @150 km/h (N):	Frontal/ Lateral/Rearside: 203/58/255
Max. Wind velocity(km/h)	200

Typical Patterns

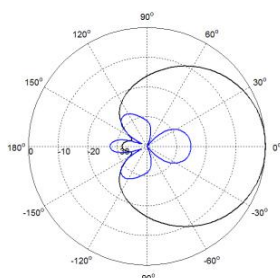

Azimuth(Low band)

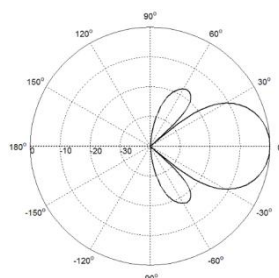

Elevation(Low band)

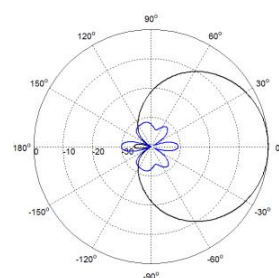

Azimuth(High band)

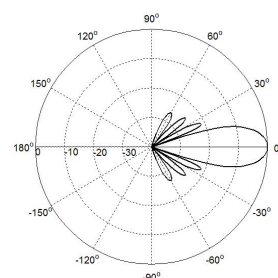

Elevation(High band)

ULPX302.4F3

Bottom View

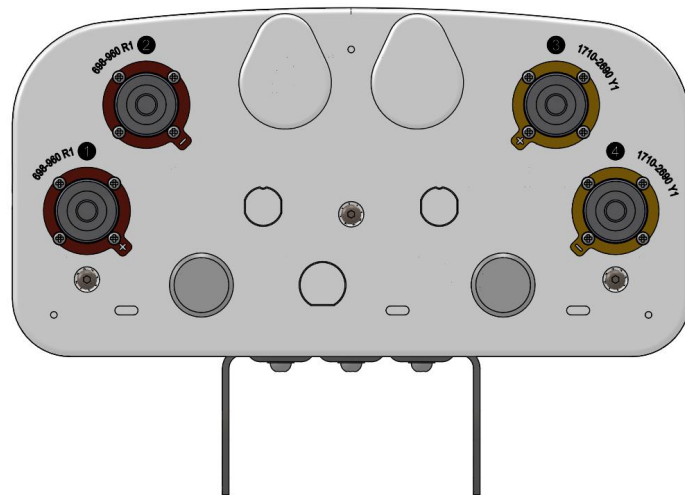

Correlation Table

Frequency range	Array	Connector
698–960 MHz	R1	1-2
1710–2690 MHz	Y1	3-4

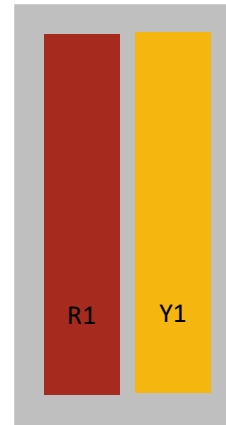

Product Data Sheet

ULPX302.4F3-V1

XX Pol Panel Antenna 698-960/1710-2690MHz 65°/65° 11/14dBi 3°/3° FET

Electrical Specifications

Frequency Range (MHz):	698-960(R1)			1710-2690(Y1)		
	698-806	806-880	880-960	1710-1920	1920-2170	2490-2690
Gain (dBi):	10.0±0.5	9.7±0.5	10.5±0.5	12.5±0.5	13.5±0.5	15.0±0.5
Return Loss (dB):	>14(VSWR<1.5)					
Polarization:	±45°					
Horizontal 3dB Beamwidth (°):	72	75	72	72	68	58
Vertical 3dB Beamwidth (°):	42	38	33	21	18	15
Electrical Downtilt (°):	3 Fixed			3 Fixed		
1 st Upper Sidelobe Suppression (dB):	14	12	8	18	17	16
Front to Back Ratio (dB):	23	23	23	23	23	23
Cross Polar Ratio 0° (dB):	15	15	15	15	15	15
Cross Polar Ratio ±60° (dB):	12	10	8	10	8	5
Isolation Port to Port (dB):	>25					
Max. Power Per Port (W):	150			150		
Intermodulation IM3 (dBc):	<-150(2×43 dBm)					
Impedance (ohm):	50					
Lightning Protection:	DC Grounded					
Connector Type:	4×7/16 DIN Female					

BASTA Electrical Specifications

Frequency Range(MHz):	698-960(R1)			1710-2690(Y1)		
	698-806	806-880	880-960	1710-1920	1920-2170	2490-2690
Average Gain by all Beam Tilts (dBi):	9.9	9.7	10.4	12.7	13.9	15.3
Gain by all Beam Tilts Tolerance(dB):	±0.4	±0.4	±0.3	±0.7	±0.5	±0.3
Average Gain by Beam Tilt (dBi):	9.9	9.7	10.4	12.7	13.9	15.3
Horizontal Beamwidth Tolerance(°):	±4.3	±4.2	±3.8	±5	±7	±3.5
Vertical Beamwidth Tolerance(°):	±3.5	±2.4	±1.7	±0.7	±0.5	±0.6
USLS beampeak to 20° above beampeak (dB):	16	16	16	16	16	16
Front to back Total Power at 180° ± 30°(dB):	23	23.8	23.4	24.5	26	23.5
CPR at Boresight(dB):	15.4	18.8	21.2	23	20	23
CPR at Sector(dB):	11	8	8	9	8	2

Mechanical Data

Antenna Dimensions (mm):	495×300×150
Packing Dimensions (mm):	710×380×240
Antenna Net Weight (kg):	6
Antenna Gross Weight (kg):	10
Radome Material:	PVC, UV Resistant
Pipe OD (mm):	30-50
Mounting Kits (Included):	BA.K.04.00047 Support Pole installation , Wall mounted installation

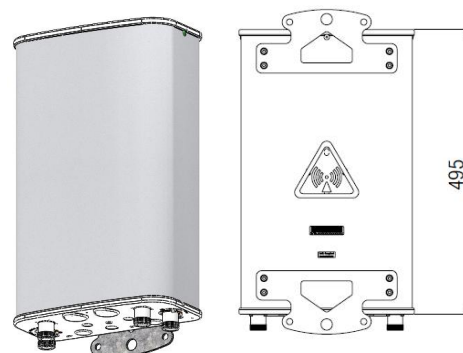

Product Data Sheet

ULPX302.4F3-V1

Environmental Ratings

Humidity:	95%RH@+30°C
Temperature (°C):	-40~+70
Wind Load @150 km/h (N):	Frontal/ Lateral/Rearside: 203/58/255
Max. Wind velocity (km/h):	200

Typical Patterns

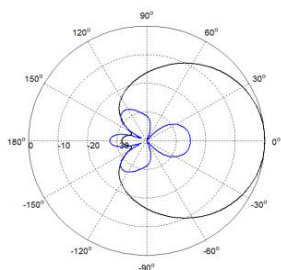

Azimuth(Low band)

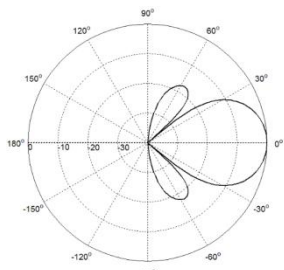

Elevation(Low band)

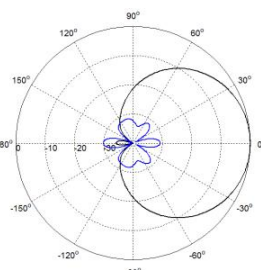

Azimuth(High band)

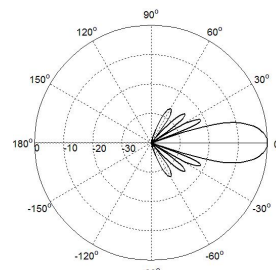

Elevation(High band)

Bottom View

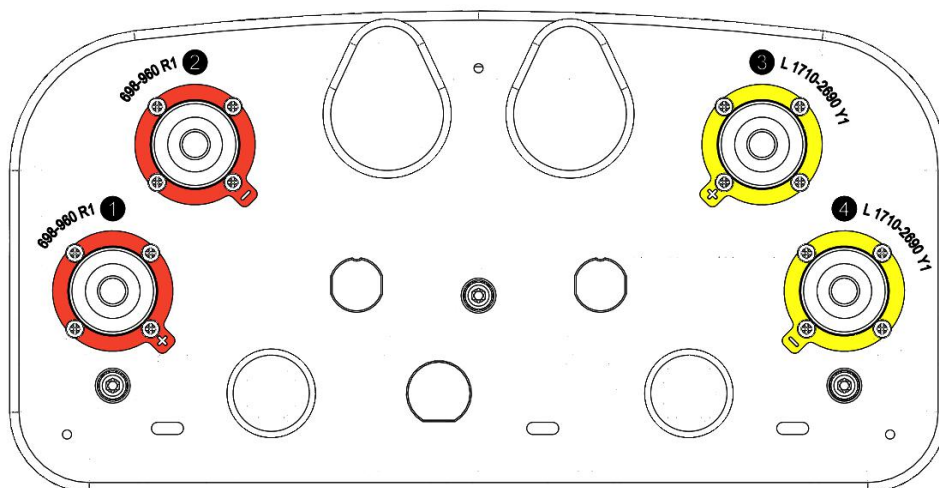

Correlation Table

Frequency range	Array	Connector
698-960 MHz	R1	1-2
1710-2690 MHz	Y1	3-4

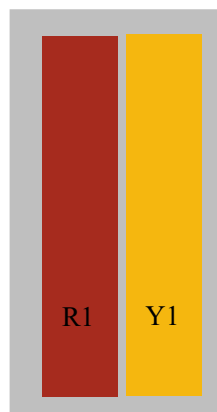

Product Data Sheet

ULPX302.4F3-V1-C

XX Pol Panel Antenna 698-960/1710-2690MHz 65°/65° 11/14dBi 3°/3° FET

Electrical Specifications

Frequency Range (MHz):	698-960(R1)			1710-2690(Y1)		
	698-806	806-880	880-960	1710-1920	1920-2170	2490-2690
Gain (dBi):	10.0±0.5	9.7±0.5	10.5±0.5	12.5±0.5	13.5±0.5	15.0±0.5
Return Loss (dB):	>14(VSWR<1.5)					
Polarization:	±45°					
Horizontal 3dB Beamwidth (°):	72	75	72	72	68	58
Vertical 3dB Beamwidth (°):	42	38	33	21	18	15
Electrical Downtilt (°):	3 Fixed					
1 st Upper Sidelobe Suppression (dB):	14	12	8	18	17	16
Front to Back Ratio (dB):	23	23	23	23	23	23
Cross Polar Ratio 0° (dB):	15	15	15	15	15	15
Cross Polar Ratio ±60° (dB):	12	10	8	10	8	5
Isolation Port to Port (dB):	>25					
Max. Power Per Port (W):	150					
Intermodulation IM3 (dBc):	<-150(2×43 dBm)					
Impedance (ohm):	50					
Lightning Protection:	DC Grounded					
Connector Type:	4×4.3-10 Female					

BASTA Electrical Specifications

Frequency Range(MHz)	698-960(R1)			1710-2690(Y1)		
	698-806	806-880	880-960	1710-1920	1920-2170	2490-2690
Average Gain by all Beam Tilts (dBi):	9.9	9.7	10.4	12.7	13.9	15.3
Gain by all Beam Tilts Tolerance(dB):	±0.4	±0.4	±0.3	±0.7	±0.5	±0.3
Average Gain by Beam Tilt (dBi):	9.9	9.7	10.4	12.7	13.9	15.3
Horizontal Beamwidth Tolerance(°):	±4.3	±4.2	±3.8	±5	±7	±3.5
Vertical Beamwidth Tolerance(°):	±3.5	±2.4	±1.7	±0.7	±0.5	±0.6
USLS beampeak to 20° above beampeak (dB):	16	16	16	16	16	16
Front to back Total Power at 180° ± 30°(dB):	23	23.8	23.4	24.5	26	23.5
CPR at Boresight(dB):	15.4	18.8	21.2	23	20	23
CPR at Sector(dB):	11	8	8	9	8	2

Mechanical Data

Antenna Dimensions (mm):	495×300×150
Packing Dimensions (mm):	710×380×240
Antenna Net Weight / Bracket (kg):	6/2.5
Antenna Gross Weight (kg):	10
Radome Material:	PVC, UV Resistant
Pipe OD (mm):	30-50
Mounting Kits (Included):	BA.K.04.00047 Support Pole installation , Wall mounted installation

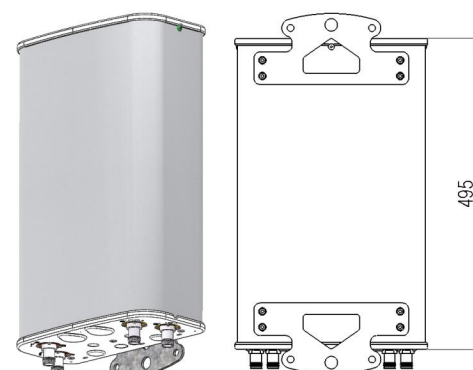

Product Data Sheet

ULPX302.4F3-V1-C

Environmental Ratings

Humidity:	95%RH@+30°C
Temperature (°C):	-40~+70
Wind Load @150 km/h (N):	Frontal/ Lateral/Rearside: 203/58/255
Max. Wind velocity (km/h):	200

Typical Patterns

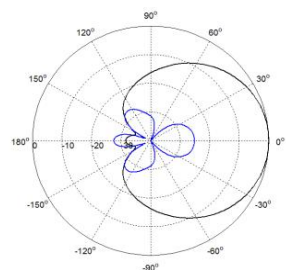

Azimuth(Low band)

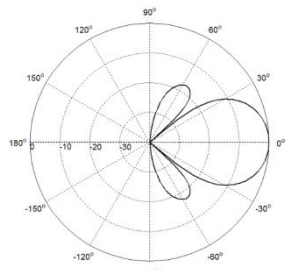

Elevation(Low band)

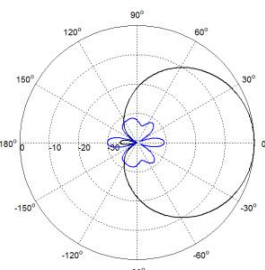

Azimuth(High band)

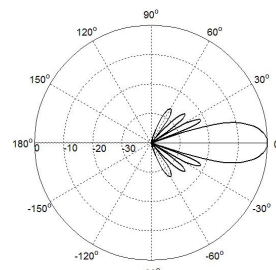

Elevation(High band)

Bottom View

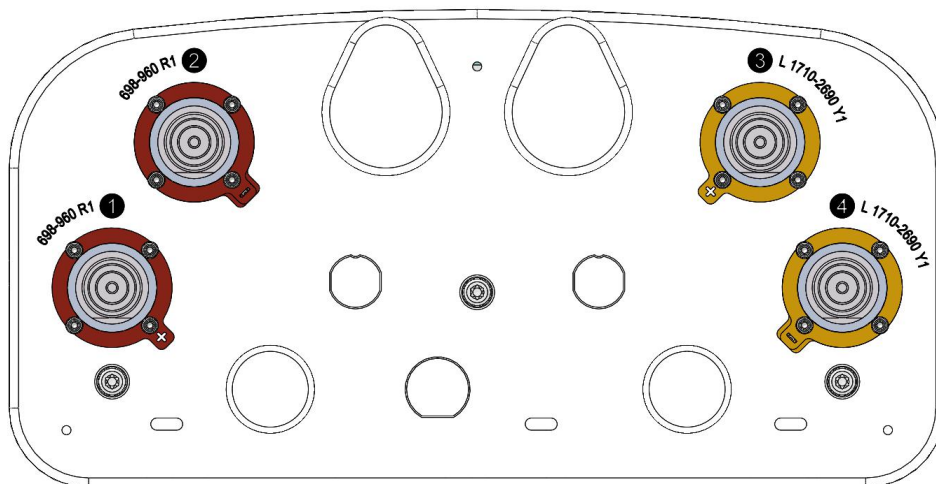

Correlation Table

Frequency range	Array	Connector
698–960 MHz	R1	1-2
1710–2690 MHz	Y1	3-4

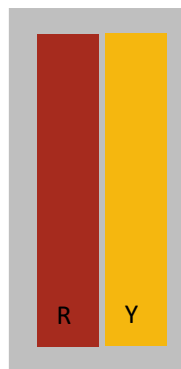

Product Data Sheet

ULPX305.10P-2P-C

XX Pol Panel Antenna Built-in Diplexer 698-960/1710-2690MHz 65°/65° 14/17dBi
0°-14°/0°-10°Replaceable RET

Electrical Specifications

Frequency Range (MHz):	698-960(R1)			1710-2690(Y1)		
	698-806	806-880	880-960	1710-2170	2300-2490	2490-2690
Gain (dBi):	13.2±0.5	13.6±0.5	14±0.5	15.5±0.5	16.4±0.5	16.8±0.5
Return Loss (dB):	>14 (VSWR<1.5)					
Polarization:	±45°					
Horizontal 3dB Beamwidth (°):	69	65	62	68	62	58
Vertical 3dB Beamwidth (°):	17	15.5	14	7.5	6.0	5.5
Electrical Downtilt (°):	0-14			0-10		
1 st Upper Sidelobe Suppression (dB):	16	15	15	15	15	15
Front to Back Ratio (dB):	22	23	24	25	25	25
Cross Polar Ratio 0°(dB):	15	15	15	15	15	15
Intraband Isolation (dB):	>25			>28		
Interband Isolation (dB):	>28					
Max. Power Per Port (W):	250			200		
Intermodulation IM3 (dBc):	<-150(2×43 dBm)					
Impedance (ohm):	50					
Lightning Protection:	DC Grounded					
Connector Type:	2×4.3-10 Female					

BASTA Electrical Specification

Frequency Range(MHz):	698-960(R1)			1710-2690(Y1)		
	698-806	806-880	880-960	1710-2170	2300-2490	2490-2690
Average Gain by all Beam Tilts (dBi):	12.8	13.5	13.9	15.7	16.6	16.8
Gain by all Beam Tilts Tolerance(dB):	±0.6	±0.4	±0.4	±0.6	±0.5	±0.4
Average Gain by Beam Tilt (dBi):	0° 13.1	0° 13.9	0° 14.5	0° 15.6	0° 16.7	0° 16.9
	7° 12.8	7° 13.5	7° 13.9	5° 15.9	5° 16.9	5° 17.1
	14° 12.5	14° 13.1	14° 13.2	10° 15.5	10° 16.3	10° 16.4
Horizontal Beamwidth Tolerance(°):	±3.5	±2.2	±1.4	±5.5	±4.7	±3.9
Vertical Beamwidth Tolerance(°):	±0.9	±0.7	±0.4	±0.8	±0.5	±0.4
USLS to 20° above beampeak(dB):	17.5	17.5	17.9	17.9	18.3	17.7
Front to back Ratio at 180° ± 30°(dB)	24.2	25.3	25	25	27.4	26.8
CPR at Boresight(dB):	15.5	15.2	15.6	15.3	15.6	15

Mechanical Data

Antenna Dimensions (mm):	1445×339×169
Packing Dimensions (mm):	1735×425×260
Antenna Net Weight/Bracket (kg):	16/ 5.9
Antenna Gross Weight (kg):	25.5
Radome Material:	Fiberglass
Pipe OD (mm):	50-114
Mounting Kits (Included):	BA.K.04.00069351 , Adjustable Downtilt 0°-16°

Environmental Ratings

Humidity:	95%RH@+30℃
Temperature (℃):	-40~+70
Wind Load @150 km/h (N):	Frontal/ Lateral/ Rearside: 852 / 247 / 994
Max.Wind velocity(km/h):	200

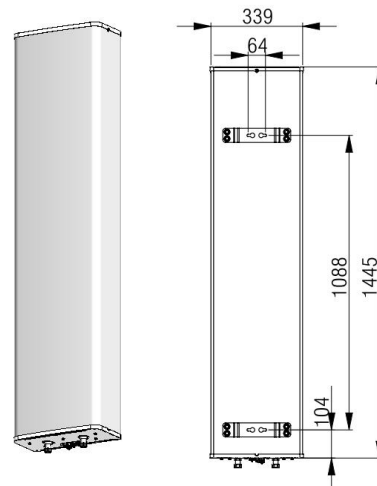

ULPX305.10P-2P-C

Internal RET Specifications

RET Type:	Replaceable RET
RET protocol:	AISG2.0 /3GPP
Input voltage range(V):	10-30 DC
Power consumption(W):	< 5 (motor activated , single RET) < 1 (stand by, single RET), < 1.5 (stand by, 12V)
Adjustment time (full range) (s):	< 120 (typically, depending on antenna type)
RET connector:	pair of AISG 5 pin male & female
Pin assignment according AISG:	8pin circular connector conforming to IEC 60130-9 - Ed. 3.0
Lightning protection (kA):	5 (8/20 μs Differential mode), 8 (8/20 μs Common mode)

Typical Patterns

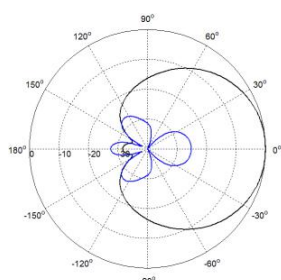

Azimuth(Low Band)

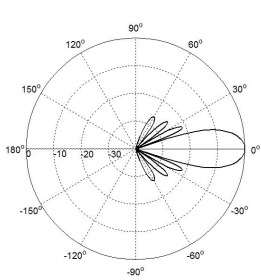

Elevation(Low Band)

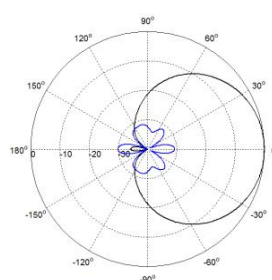

Azimuth(High Band)

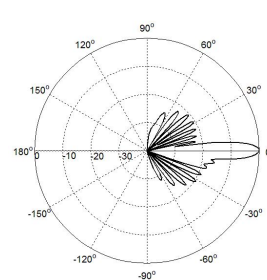

Elevation(High Band)

Bottom View

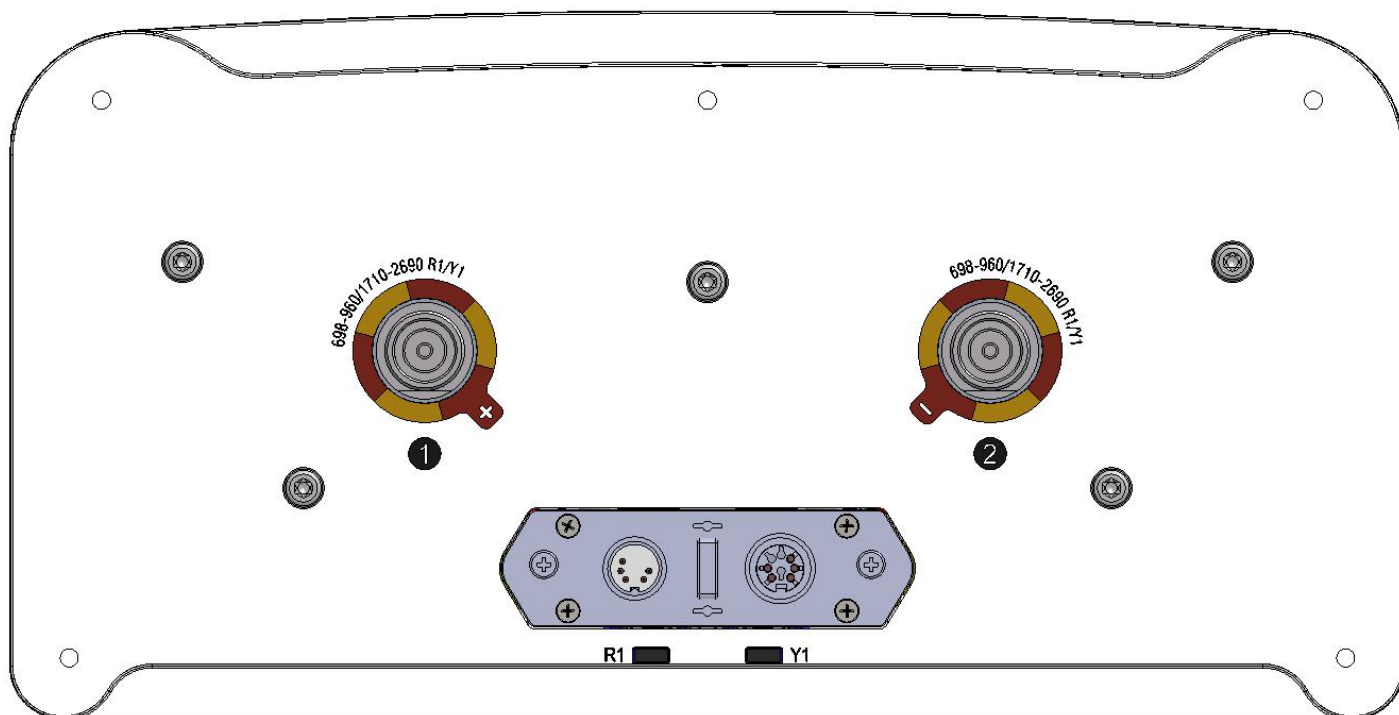

ULPX305.10P-2P-C

Correlation Table

Frequency range	Array	Connector	RET S/N
698– 960 MHz	R1	1-2	BRxxx.....1R1
1710–2690 MHz	Y1	1-2	BRxxx.....2Y1

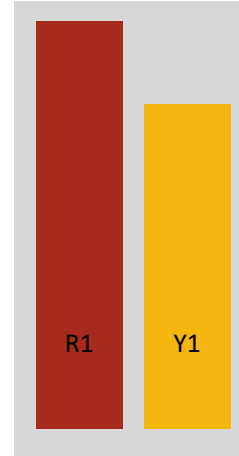

Product Data Sheet

ULPX309.12P-C

XX Pol Panel Antenna 698-960/1710-2690MHz 65°/65° 1717.5dBi 0°-10°/0°-10° Replaceable RET

Electrical Specifications

Frequency Range (MHz):	698-960(R1)			1710-2690(Y1)		
	698-806	806-880	880-960	1710-2170	2300-2490	2490-2690
Gain (dBi):	15.7±0.5	16.2±0.5	16.5±0.5	16.8±0.5	17.5±0.5	17.8±0.5
Return Loss (dB):	>14 (VSWR<1.5)					
Polarization:	±45°					
Horizontal 3dB Beamwidth (°):	70	68	66	68	62	58
Vertical 3dB Beamwidth (°):	9.0	8.0	7.0	6.5	5.5	4.5
Electrical Downtilt (°):	0-10			0-10		
1 st Upper Sidelobe Suppression (dB):	15	15	15	15	15	15
Front to Back Ratio (dB):	22	23	24	25	25	25
Cross Polar Ratio 0°(dB):	15	15	15	15	15	15
Intraband Isolation (dB):	>26			>28		
Interband Isolation (dB):	>28					
Max. Power Per Port (W):	250			200		
Intermodulation IM3 (dBc):	<-150(2×43 dBm)					
Impedance (ohm):	50					
Lightning Protection:	DC Grounded					
Connector Type:	4×4.3-10 Female					

Mechanical Data

Antenna Dimensions (mm):	2495×339×169
Packing Dimensions (mm):	2755×420×255
Antenna Net Weight/Bracket (kg):	26 / 5.9
Antenna Gross Weight (kg):	38
Radome Material:	Fiberglass
Pipe OD (mm):	50-115
Mounting Kits (Included):	BA.K.04.00069091 ,Adjustable Downtilt 0°-10°

**Environmental Ratings**

Humidity:	95%RH@+30°C
Temperature (°C):	-40~+70
Wind Load @150 km/h (N):	Frontal/Lateral/Rearside:1099 / 382/ 1338
Max. Wind velocity(km/h):	200

Internal RET Specifications

RET type:	Replaceable RET
RET protocol:	AISG 2.0 /3 GPP
Input voltage range(V):	10-30 DC
Power consumption(W):	< 5 (motor activated , single RET) < 1 (stand by, single RET), < 1.5 (stand by, 12V)
Adjustment time (full range) (s):	< 120 (typically, depending on antenna type)
RET connector:	1 pair of AISG 5 pin male & female
Pin assignment according AISG:	8 pin circular connector conforming to IEC 60130-9 - Ed. 3.0
Lightning protection (kA):	5 (8/20 μs Differential mode), 8 (8/20 μs Common mode)

Product Data Sheet

ULPX309.12P-C

Typical Patterns

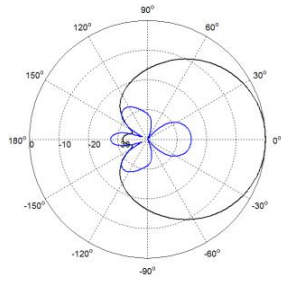

Azimuth(Low Band)

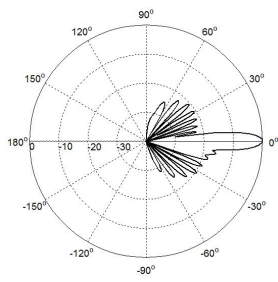

Elevation(Low Band)

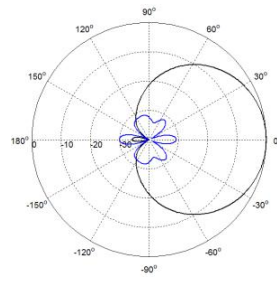

Azimuth(High Band)

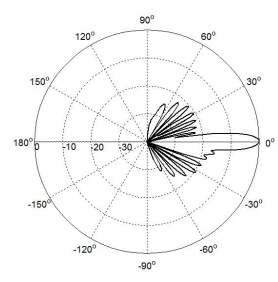

Elevation(High Band)

Correlation Table

Frequency range	Array	Connector
698– 960 MHz	R1	1-2
1710–2690 MHz	Y1	3-4

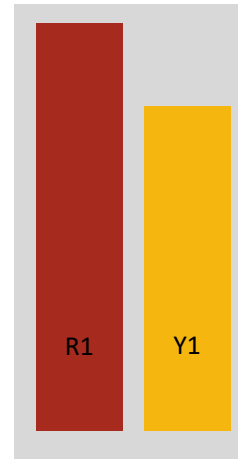

Product Data Sheet

LVPX203F0-2P

XX Pol Panel Antenna 1710-2700/3300-3800MHz 25° 15dBi 0° FET

Electrical Specifications

Frequency Range (MHz):	1710-2700(Y1)	3300-3800(P1)
Gain (dBi):	15±0.5	15±0.5
Return Loss (dB):	>14(VSWR<1.5)	
Polarization:	±45°	
Horizontal 3dB Beamwidth (°):	25±6	25±6
Vertical 3dB Beamwidth (°):	25±6	25±6
Electrical Downtilt (°):	0	
Upper Sidelobe Suppression (dB):	>20	>20
Front to Back Ratio (dB):	>25	>25
Cross Polar Ratio 0° (dB):	>20	>20
Isolation Port to Port (dB):	>25	
Intermodulation IM3 (dBC):	<-150 (2×43 dBm)	
Power Rating (W):	150	
Impedance (ohm):	50	
Lightning Protection:	DC Grounded	
Connector Type:	2×7/16 DIN Female	

BASTA Electrical Specifications

Frequency Range(MHz):	1710-2700	3300-3800
Average Gain by all Beam Tilts (dBi):	16.86	15.91
Gain by all Beam Tilts Tolerance(dB):	±1.75	±1.44
Average Gain by Beam Tilt (dBi):	0° 16.86	0° 15.91
Horizontal Beamwidth Tolerance(°):	±6.03	±1.35
Vertical Beamwidth Tolerance(°):	±5.7	±1.6
USLS beampeak to 20° above beampeak(dB):	32.56	26.61
Front to back Total Power at 180° ± 30°(dB)	28.13	27.16
CPR at Boresight(dB):	25.56	21.2

Mechanical Data

Antenna Dimensions (mm):	750×448×145
Packing Dimensions (mm):	1115×515×190
Antenna Net Weight/Bracket (kg):	9.5/5.7
Antenna Gross Weight (kg):	13.5
Radome Material:	Fiberglass
Pipe OD (mm):	70-114
Mounting Kits (Included):	BA.K.04.00011, Adjustable Downtilt 0-20°

Environmental Ratings

Humidity:	95%RH@+30°C
Temperature (°C):	-40~+70
Wind Load @150 km/h (N):	Frontal/Lateral/Rearside: 435/57/483
Max.Wind velocity(km/h)	200

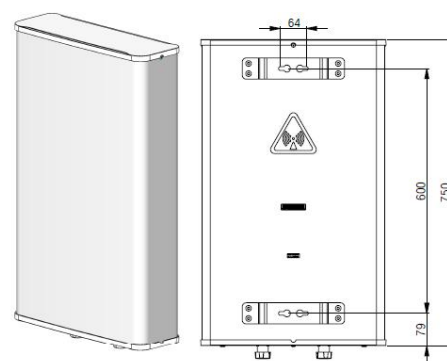

LVPX203F0-2P

Typical Patterns

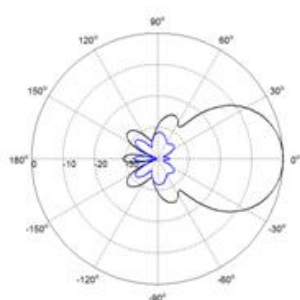

Azimuth

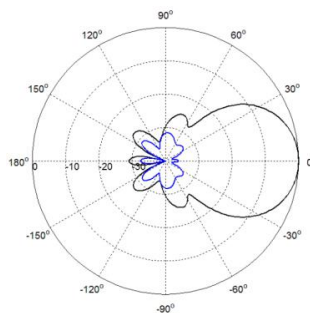

Elevation

Bottom View

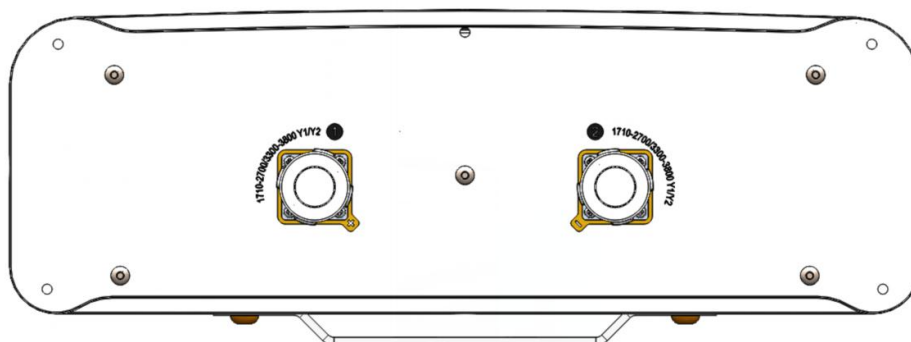

Correlation Table

Frequency range	Array	Connector
3300-3800MHz	P1	1-2
1710-2700MHz	Y1	1-2

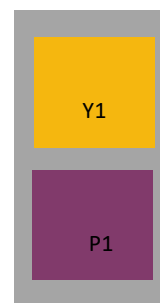

Product Data Sheet

LVPX203F0

XX Pol Panel Antenna 1710-2700/3300-3800MHz 25° 15dBi 0° FET

Electrical Specifications

Frequency Range (MHz):	1710-2700(Y1)	3300-3800(P1)
Gain (dBi):	15±0.5	15±0.5
Return Loss (dB):	>14(VSWR<1.5)	
Polarization (°):	±45	
Horizontal 3dB Beamwidth (°):	25±6	25±6
Vertical 3dB Beamwidth (°):	25±6	25±6
Electrical Downtilt (°):	0	
1 st Upper Sidelobe Suppression (dB):	>20	>20
Front to Back Ratio (dB):	>25	>25
Cross Polar Ratio 0° (dB):	>20	>20
Isolation Port to Port (dB):	>25	
Intermodulation IM3 (dBc):	<-150 (2×43 dBm)	
Max. Power Per Port (W):	150	
Impedance (ohm):	50	
Lightning Protection:	DC Grounded	
Connector Type:	4×7/16 DIN Female	

Mechanical Data

Antenna Dimensions (mm):	750×448×145
Packing Dimensions (mm):	1070×515×220
Antenna Net Weight/Bracket (kg):	10/5.7
Antenna Gross Weight (kg):	17.5
Radome Material:	Fiberglass
Pipe OD (mm):	70-114
Mounting Kits (Included):	BA.K.04.00011, Adjustable Downtilt 0°-20°

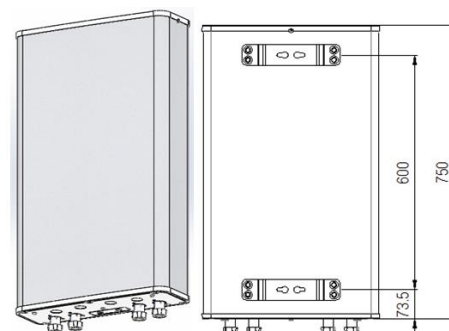

Environmental Ratings

Humidity:	95%RH@+30℃
Temperature (℃):	-40~+70
Wind Load @150 km/h (N):	Frontal/Lateral/Rearside: 435/57/483
Max. Wind velocity (km/h)	200

Typical Patterns

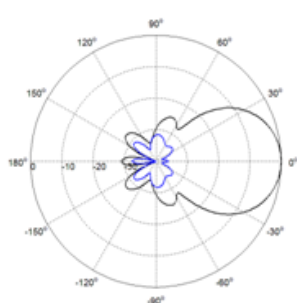

Azimuth

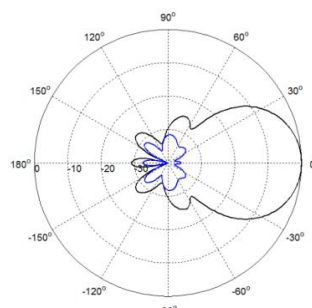

Elevation

LVPX203F0

Bottom View

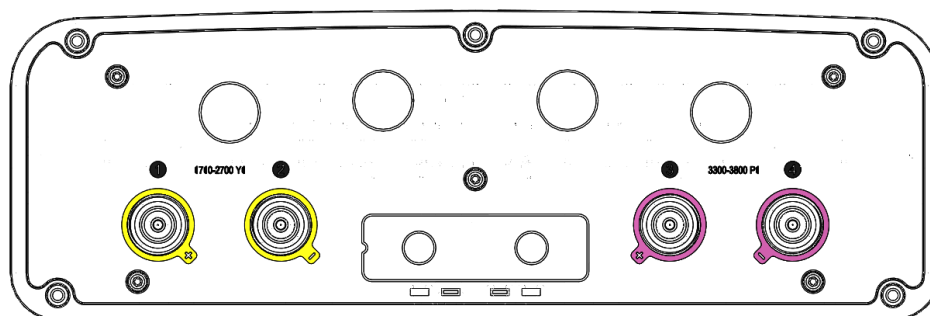

Correlation Table

Frequency range	Array	Connector
1710-2700MHz	Y1	1-2
3300-3800MHz	P1	3-4

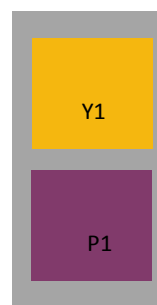

Product Data Sheet

UL2PX205.10P-E2-C

XXX Pol Panel Antenna 694-960/2×1710-2690MHz 33°/33° 16/20dBi 2°-12°/2°-12° Replaceable RET

Electrical Specifications

Frequency Range (MHz):	694-960(R1)			2×1710-2690(Y1,Y2)		
	694-806	806-880	880-960	1710-2170	2300-2490	2490-2690
Gain (dBi):	15.3±0.5	15.8±0.5	16.2±0.5	19.0±0.5	19.5±0.5	20.0±0.5
Return Loss (dB):	>14 (VSWR<1.5)					
Polarization:	±45°					
Horizontal 3dB Beamwidth (°):	39±5	34±4	30±3	38±5	33±4	28±3
Vertical 3dB Beamwidth (°):	17.0	15.3	13.0	6.7	5.5	5
1 st Upper Sidelobe Suppression(dB):	15	15	15	15	15	15
Electrical Downtilt (°):	2-12			2-12		
RET Type:	Cascade SRET, AISG 2.0, Upgradeable					
Front to Back Ratio (dB):	23	23	23	25	25	25
Cross Polar Ratio 0° (dB):	15	15	15	15	15	15
Cross Polar Ratio ±15° (dB):	>10			>10		
Intraband Isolation (dB):	>25			25		
Interband Isolation (dB):	>28					
Max. Power Per Port (W):	250			200		
Intermodulation IM3 (dBc):	<-150 (2×43 dBm)					
Impedance (ohm):	50					
Lightning Protection:	DC Grounded					
Connector Type:	6×4.3-10 Female					

BASTA Electrical Specification

Frequency Range(MHz):	694-960(R1)			2×1710-2690(Y1,Y2)		
	694-806	806-880	880-960	1710-2170	2300-2490	2490-269
Average Gain by all Beam Tilts (dBi):	15.3	15.8	16.2	19.0	19.5	20.0
Gain by all Beam Tilts Tolerance(dB):	±0.6	±0.5	±0.5	±0.5	±0.5	±0.5
Average Gain by Beam Tilt (dBi):	2° 15.4	2° 15.9	2° 16.4	2° 19.1	2° 19.6	2° 20.2
	7° 15.3	7° 15.8	7° 16.2	7° 19.0	7° 19.4	7° 20.0
	12° 15.1	12° 15.7	12° 16.0	12° 18.8	12° 19.2	12° 19.8
Horizontal Beamwidth Tolerance(°):	±4	±3	±3	±3.5	±2.8	±2.5
Vertical Beamwidth Tolerance(°):	±2.0	±1.8	±1.5	±1.5	±1.3	±1.2
USLS to 20° above beampeak(dB):	15.7	16.7	15.8	16.2	16.0	15.7
Front to back Ratio at 180° ± 30°(dB)	23.8	25.2	25.8	25.3	25.6	26.5
CPR at Boresight(dB):	15.8	16.2	15.6	16.2	16.5	15.8
CPR at Sector(dB):	11.6	11.5	11.2	11.9	11.2	10.5

Product Data Sheet

UL2PX205.10P-E2-C

Mechanical Data

Antenna Dimensions (mm):	1350×498×197
Packing Dimensions (mm):	1670×580×290
Antenna Net Weight /Bracket (kg):	26/5.7
Antenna Gross Weight (kg):	36
Radome Material:	Fiberglass
Pipe OD (mm):	70-114
Mounting Kits (Included):	BA.K.04.00011, Adjustable Downtilt 0°-14°

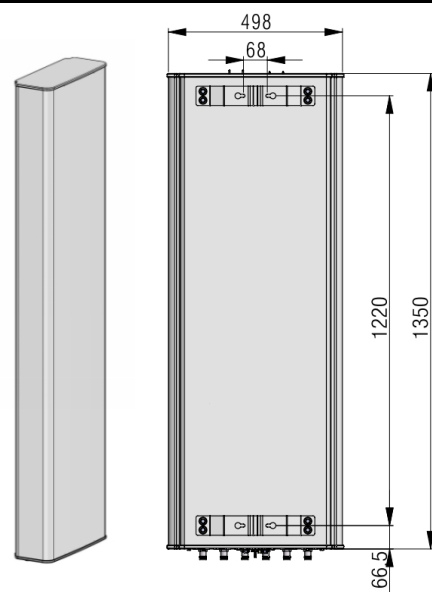

Environmental Ratings

Humidity:	95%RH@+30°C
Temperature (°C):	-40~+70
Wind Load @150 km/h (N):	Frontal/Lateral/Rearside:1160/226/1224
Max. Wind velocity(km/h):	200

RET Specifications

RET Type:	Replaceable RET
RET protocol:	AISG 2.0 /3 GPP
Input voltage range(V):	10-30 DC
Power consumption(W):	< 5 (motor activated, single RET) < 1 (stand by, single RET), < 1.5 (stand by, 12V)
Adjustment time (full range) (s):	< 120 (typically, depending on antenna type)
RET connector:	1 pair of AISG 5 pin male & female
Pin assignment according AISG:	8 pin circular connector conforming to IEC 60130-9 - Ed. 3.0
Lightning protection (kA):	5 (8/20 μs Differential mode), 8 (8/20 μs Common mode)

Typical Patterns

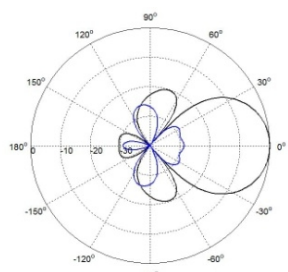

Azimuth(Low Band)

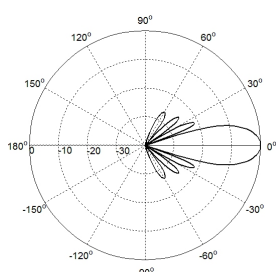

Elevation(Low Band)

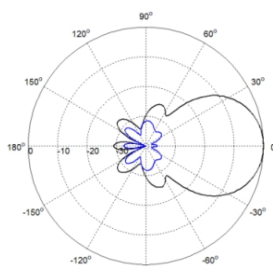

Azimuth(High Band)

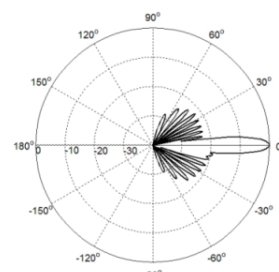

Elevation(High Band)

Bottom View

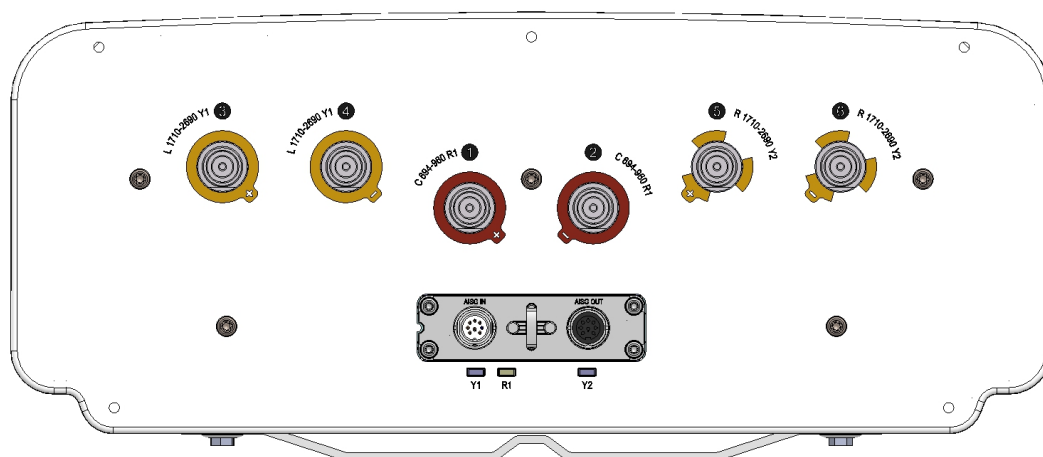

Product Data Sheet

UL2PX205.10P-E2-C

Correlation Table

Frequency range	Array	Connector	RET S/N
694-960 MHz	R1	1-2	BRxxx.....1R1
1710-2690 MHz	Y1	3-4	BRxxx.....2Y1
1710-2690 MHz	Y2	5-6	BRxxx.....3Y2

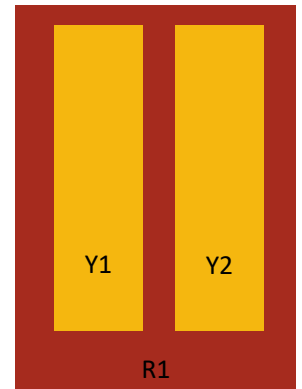

Product Data Sheet

UL2PX302.4F3

XXX Pol Panel Antenna 698-960/2×1710-2690MHz 65°/65° 10.5/15dBi 3°/3° FET

Electrical Specifications

Frequency Range (MHz):	698-960(R1)			2×1710-2690(Y1,Y2)		
	698-806	806-880	880-960	1710-1920	1920-2170	2490-2690
Gain (dBi):	9.5±0.5	9.7±0.5	10.5±0.5	12.5±0.5	13.5±0.5	15.0±0.5
Return Loss (dB):	>14(VSWR<1.5)					
Polarization:	±45°					
Horizontal 3dB beamwidth (°):	75	70	70	67	70	60
Vertical 3dB beamwidth (°):	42	35	33	20.5	19	15.5
Electrical Downtilt (°):	3 Fixed(Typ.)			3 Fixed(Typ.)		
1 st Upper Sidelobe Level (dB):	14	12	8	18	17	16
Front to Back Ratio (dB):	23	23	23	23	23	23
Cross Polar Ratio 0° (dB):	15	15	15	15	15	15
Cross Polar Ratio ±60° (dB):	12	10	8	10	8	5
Isolation Port to Port (dB):	>25					
Max. Power Per Port (W):	150			150		
Intermodulation IM3 (dBc):	<-150 (2×43 dBm)					
Impedance (ohm):	50					
Lightning Protection:	DC Grounded					
Connector Type:	6×7/16 DIN Female					

BASTA Electrical Specifications

Frequency Range(MHz):	698-806	806-880	880-960	2×1710-192	2×1920-217	2×2490-2690
Average Gain by all Beam Tilts (dBi):	9.9	9.7	10.4	12.7	13.9	15.3
Gain by all Beam Tilts Tolerance(dB):	0.4	0.4	0.3	0.7	0.5	0.3
Average Gain by Beam Tilt (dBi):	9.9	9.7	10.4	12.7	13.9	15.3
Horizontal Beamwidth Tolerance(°):	4.3	4.2	3.8	5	7	3.5
Vertical Beamwidth Tolerance(°):	3.5	2.4	1.7	0.7	0.5	0.6
USLS beampeak to 20° above beampeak(dB):	16	16	16	16	16	16
Front to back Total Power at 180° ± 30°(dB):	23	23.8	23.4	24.5	26	23.5
CPR at Boresight(dB):	15.4	18.8	21.2	23	20	23
CPR at Sector(dB):	11	8	8	9	8	2

Mechanical Data

Antenna Dimensions (mm):	492×339×169
Packing Dimensions (mm):	734×466×314
Antenna Net Weight (kg):	7.2
Antenna Gross Weight (kg):	12.5
Radome Material:	Fiberglass
Pipe OD (mm):	70-114 30-50(Optional)
Mounting Kits (Included):	BA.K.04.00033 Horizontal adjustable -35°-+35°, Vertical adjustable-45°-+45°

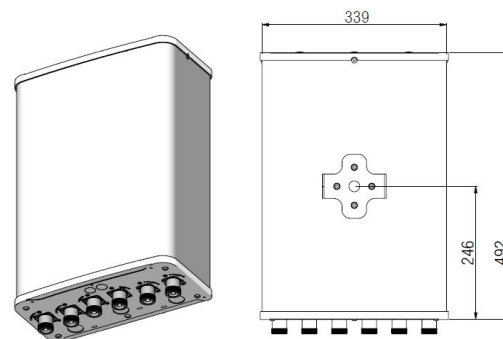

Environmental Ratings

Humidity:	95%RH@+30°C
Temperature (°C):	-40~+70
Wind Load @150 km/h (N):	Frontal/Lateral/Rearside: 277/76/323
Max.Wind velocity(km/h):	200

UL2PX302.4F3

Typical Patterns

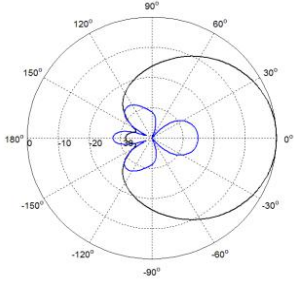

Azimuth(Low band)

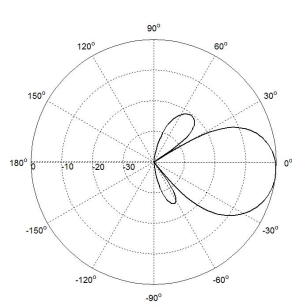

Elevation(Low band)

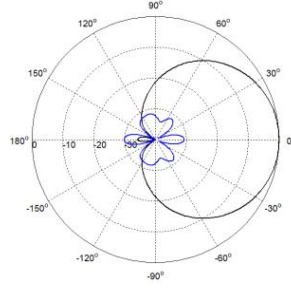

Azimuth(High band)

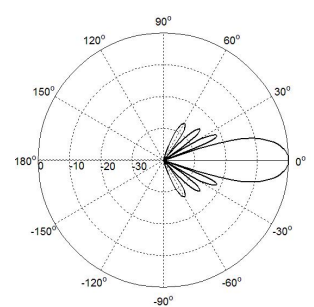

Elevation(High band)

Bottom View

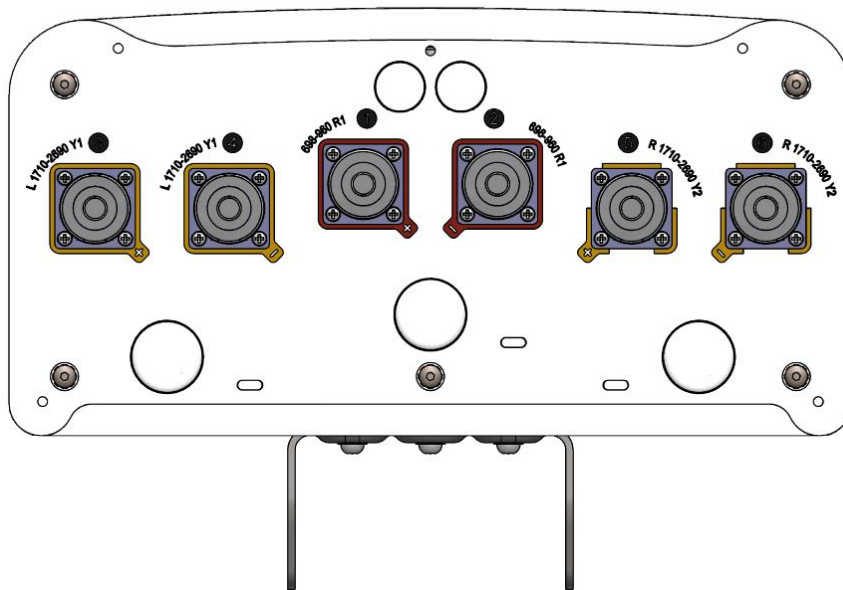

Correlation Table

Frequency range	Array	Connector
698–960 MHz	R1	1-2
1710–2690 MHz	Y1	3-4
1710–2690 MHz	Y2	5-6

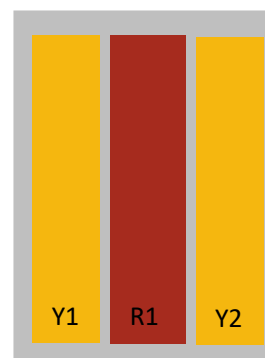

Product Data Sheet

UL2PX302.4F3-C

XXX Pol Panel Antenna 698-960/2x1710-2690MHz 65°/65° 10.5/15dBi 3°/3° FET

Electrical Specifications

Frequency Range (MHz):	698-960(R1)			2x1710-2690(Y1,Y2)		
	698-806	806-880	880-960	1710-1920	1920-2170	2490-2690
Gain (dBi):	9.5±0.5	9.7±0.5	10.5±0.5	12.5±0.5	13.5±0.5	15.0±0.5
Return Loss (dB):	>14(VSWR<1.5)					
Polarization:	±45°					
Horizontal 3dB beamwidth (°):	75	70	70	67	70	60
Vertical 3dB beamwidth (°):	42	35	33	20.5	19	15.5
Electrical Downtilt (°):	3 Fixed(Typ)			3 Fixed(Typ)		
Upper Sidelobe Suppression (dB):	14	12	8	18	17	16
Front to Back Ratio (dB):	23	23	23	23	23	23
Cross Polar Ratio 0° (dB):	15	15	15	15	15	15
Cross Polar Ratio ±60° (dB):	12	10	8	10	8	5
Isolation Port to Port (dB):	>25					
Max. Power Per Port (W):	150					
Intermodulation IM3 (dBc):	<-150(2x43 dBm)					
Impedance (ohm):	50					
Lightning Protection:	DC Grounded					
Connector Type:	6x4.3-10 Female					

BASTA Electrical Specifications

Frequency Range(MHz):	698-960(R1)			1710-2690(Y1,Y2)		
	698-806	806-880	880-960	1710-1920	1920-2170	2490-2690
Average Gain by all Beam Tilts (dBi):	9.9	9.7	10.4	12.7	13.9	15.3
Gain by all Beam Tilts Tolerance(dB):	0.4	0.4	0.3	0.7	0.5	0.3
Average Gain by Beam Tilt (dBi):	9.9	9.7	10.4	12.7	13.9	15.3
Horizontal Beamwidth Tolerance(°):	4.3	4.2	3.8	5	7	3.5
Vertical Beamwidth Tolerance(°):	3.5	2.4	1.7	0.7	0.5	0.6
USLS beampeak to 20° above beampeak (dB):	16	16	16	16	16	16
Front to back Total Power at 180° ± 30°(dB):	23	23.8	23.4	24.5	26	23.5
CPR at Boresight(dB):	15.4	18.8	21.2	23	20	23
CPR at Sector(dB):	11	8	8	9	8	2

Mechanical Data

Antenna Dimensions (mm):	492×339×169
Packing Dimensions (mm):	734×480×314
Antenna Net Weight (kg):	7.2
Antenna Gross Weight (kg):	12.5
Radome Material:	Fiberglass
Pipe OD (mm):	70-114 30-50(Optional)
Mounting Kits (Included):	BA.K.04.00033 Horizontal adjustable -35°~+35°, Vertical adjustable-45°~+45°

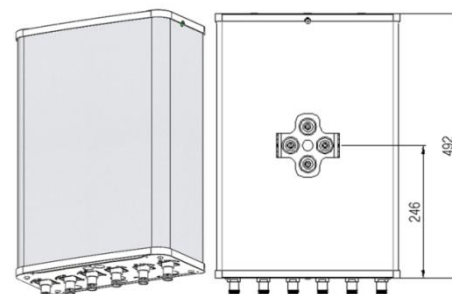

Environmental Ratings

Humidity:	95%RH@+30°C
Temperature (°C):	-40~+70
Wind Load @150 km/h (N):	Frontal/ Lateral/ Rearside: 277/76/323
Max. Wind velocity(km/h):	200

UL2PX302.4F3-C

Typical Patterns

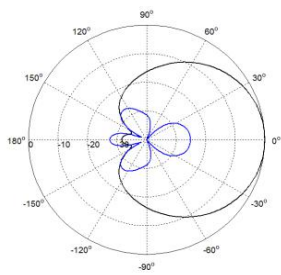

Azimuth(Low band)

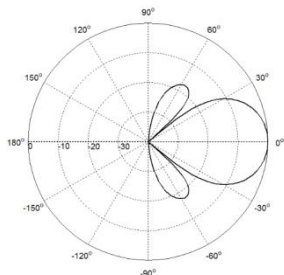

Elevation(Low band)

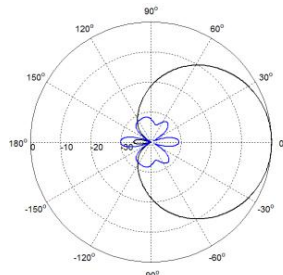

Azimuth(High band)

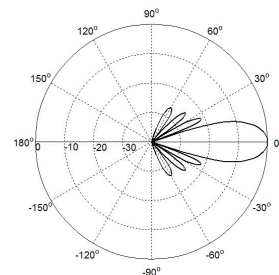

Elevation(High band)

Bottom View

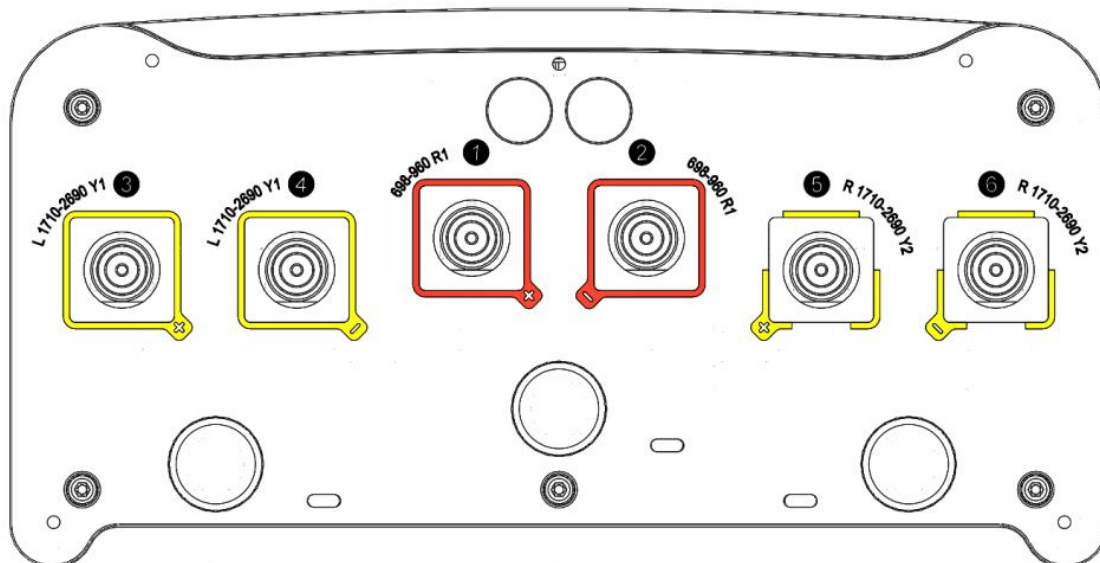

Correlation Table

Frequency range	Array	Connector
698-960 MHz	R1	1-2
1710-2690 MHz	Y1	3-4
1710-2690 MHz	Y2	5-6

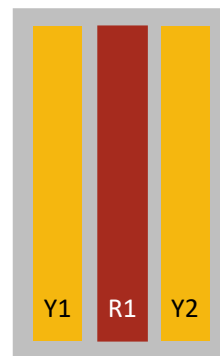

Product Data Sheet

UL2PX303.6R-E5-C

XXX Pol Panel Antenna 698-960/1710-2690/1710-2690MHz 65°/65°/65° 12/15/15 dBi
5-15°/5-15°/5-15° RET

Electrical Specifications

Frequency Range (MHz):	698-960(R1)			1710-2690(Y1,Y2)		
	698-790	790-880	880-960	1710-1920	1920-2200	2300-2690
Gain (dBi):	11.2±0.6	11.7±0.5	12.0±0.7	13.2±0.5	14.4±0.5	15.0±0.5
Return Loss (dB):	>14 (VSWR<1.5)					
Polarization:	±45°					
Horizontal 3dB Beamwidth (°):	73±5	71±5	70±5	70±5	60±5	63±5
Vertical 3dB Beamwidth (°):	28±3	25±3	22±3	15.7±1	13.7±1	11±1
Electrical Downtilt (°):	5-15 Independently Continuously Adjustable					
RET Type:	RET Cascade SRET, AISG 2.0 ,Upgradeable					
1 st Upper Sidelobe Suppression (dB):	10	8	8	13	13	13
Front to Back Ratio 180±30°(dB):	18	18	20	22	25	25
Cross Polar Ratio 0° (dB):	15			15		
Cross Polar Ratio 60° (dB)	10	8	8	8	5	8
Intraband Isolation (dB):	25			25		
Interband Isolation (dB):	25			25		
Max. Power Per Port (W):	250			200		
Intermodulation IM3 (dBc):	<-150 (2×43 dBm)					
Impedance (ohm):	50					
Lightning Protection:	DC Grounded					
Connector Type:	6×4.3-10 Female					

BASTA Electrical Specifications

Frequency Range(MHz):	698-790	790-880	880-960	1710-1920	1920-2170	2300-2690
Average Gain by all Beam Tilts (dBi):	11.5	11.6	11.7	13.4	14.2	15.0
Gain by all Beam Tilts Tolerance(dB):	±0.2	±0.2	±0.2	±0.2	±0.2	±0.2
Average Gain by Beam Tilt (dBi):	5° 11.8 10° 11.6 15° 11.3			5° 14.4 10° 14.2 15° 14.0		
Horizontal Beamwidth Tolerance(°):	±3	±3	±3	±4	±4	±4
Vertical Beamwidth Tolerance(°):	±2	±2	±3	±1.5	±1	±1
USLS beampeak to 20° above beampeak(dB):	15	12	10	15	15	15
Front to back Total Power at 180° ± 30°(dB):	24	25	25	28	30	29
CPR at Boresight(dB):	14	14	12	12	12	12
CPR at Sector(dB):	10.5	10.0	8.8	8.7	8.4	3.0

Mechanical Data

Antenna Dimensions (mm):	881×339×169
Packing Dimensions (mm):	1205×457×240
Antenna Net Weight /Bracket (kg):	13.5/5.7
Antenna Gross Weight (kg):	23
Radome Material:	Fiberglass
Pipe OD (mm):	70-114
Mounting Kits (Included):	BA.K.04.00011, Adjustable Downtilt 0-20°

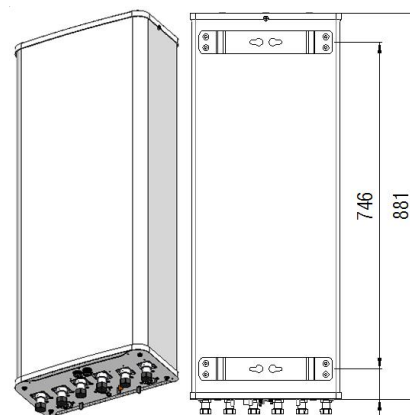

Product Data Sheet

UL2PX303.6R-E5-C

Environmental Ratings

Humidity:	95%RH@+30°C
Temperature (°C):	-40~+70
Wind Load @150 km/h (N):	Frontal/Lateral/Rearside: 508/138/593
Max .Wind velocity(km/h):	200

Internal RET Specifications

RET type:	Integrated RET
RET protocol:	AISG2.0 /3GPP
Input voltage range(V):	10-30 DC
Power consumption(W):	< 5 (motor activated ,single RET) < 1 (stand by, single RET), < 1.5 (stand by, 12V)
Adjustment time (full range) (s):	< 120 (typically, depending on antenna type)
RET connector:	two pair of AISG 8 pin male & female
Pin assignment according AISG:	8-pin circular connector conforming to IEC 60130-9 - Ed. 3.0
Lightning protection (kA):	5 (8/20 μs Differential mode), 8 (8/20 μs Common mode)

Typical Patterns

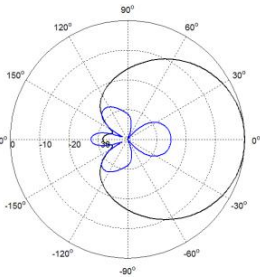

Azimuth(Low band)

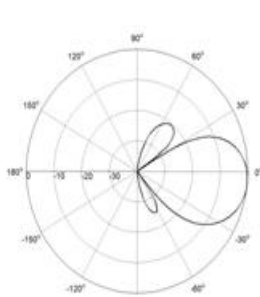

Elevation(Low band)

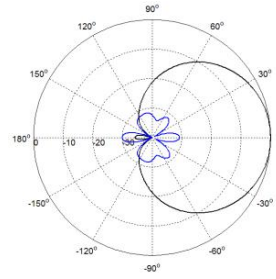

Azimuth(High band)

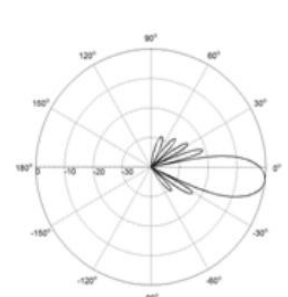

Elevation(High band)

Bottom View

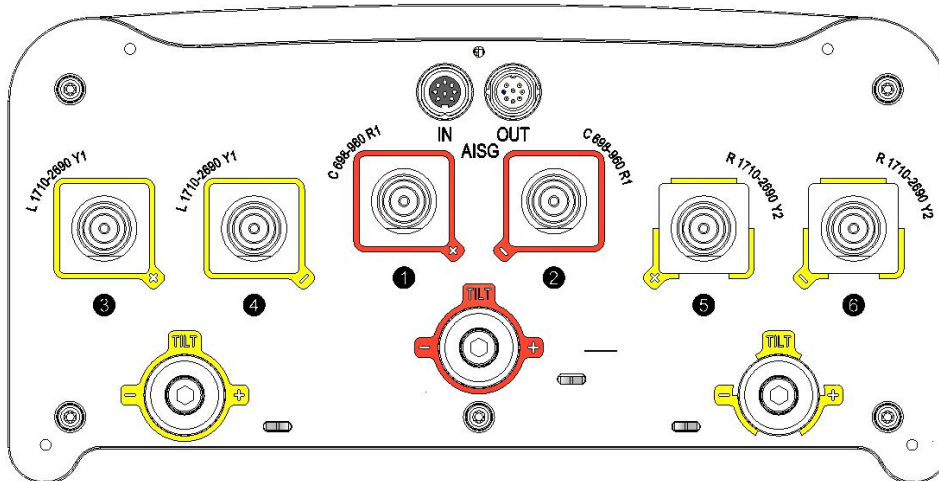

UL2PX303.6R-E5-C

Correlation Table

Frequency range	Array	Connector
698-960 MHz	R1	1-2
1710-2690 MHz	Y1	3-4
1710-2690 MHz	Y2	5-6

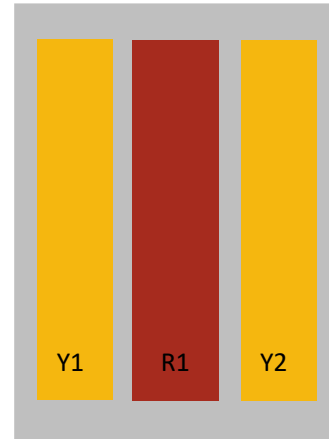

Product Data Sheet

UL2PX305.10P-E2-C

XXX Pol Panel Antenna 698-960/2×1710-2690MHz 65°/65° 14.5/17.5dBi 2°-15°/2°-12° Replaceable RET

Electrical Specifications

Frequency Range(MHz):	698-960(R1)			2×1710-2690(Y1,Y2)		
	698-806	806-880	880-960	1710-2170	2300-2490	2490-2690
Gain(dBi):	13.5±0.5	14.0±0.5	14.5±0.5	16.4±0.5	16.9±0.5	17.2±0.5
Return Loss(dB):	>14 (VSWR<1.5)					
Polarization:	±45°					
Horizontal 3dB beamwidth(°):	70	68	66	68	62	58
Vertical 3dB beamwidth(°):	17.0	15.0	13.5	7.5	6	5.5
Electrical Downtilt (°):	2-15 Independently Continuously Adjustable			2-12 Independently Continuously Adjustable		
1 st Upper Sidelobe Suppression(dB):	15	15	15	15	15	15
Front to Back Ratio(dB):	22	23	24	25	25	25
Cross Polar Ratio 0°(dB):	15	15	15	15	15	15
Intraband Isolation (dB):	>25			>28		
Interband Isolation (dB):	>28					
Max. Power Per Port (W):	250			200		
Intermodulation IM3(dBc):	<-150 (2×43 dBm)					
Impedance(ohm):	50					
Lightning Protection:	DC Grounded					
Connector Type:	6×4.3-10 Female					

Mechanical Data

Antenna Dimensions(mm):	1395×339×169
Packing Dimensions(mm):	1655×420×255
Antenna Net Weight /Bracket(kg):	19/5.9
Antenna Gross Weight(kg):	29
Radome Material:	Fiberglass
Pipe OD(mm):	50-115
Mounting Kits(Included):	BA.K.04.00069131, Adjustable Downtilt 0°-16°



Environmental Ratings

Humidity:	95%RH@+30°C
Temperature(°C):	-40~+70
Wind Load@150 km/h(N):	Frontal/Lateral/Rearside: 599/200/730
Max. Wind velocity(km/h):	200

Internal RET Specifications

RET type:	Replaceable RET
RET protocol:	AISG 2.0 /3 GPP
Input voltage range (V):	10-30 DC
Power consumption (W):	< 5 (motor activated , single RET) < 1 (stand by, single RET), < 1.5 (stand by, 12V)
Adjustment time (full range):	< 120 (typically, depending on antenna type)
RET connector:	1 pair of AISG 5 pin male & female
Pin assignment according AISG:	8 pin circular connector conforming to IEC 60130-9 - Ed. 3.0
Lightning protection (kA):	5 (8/20 μs Differential mode), 8 (8/20 μs Common mode)

UL2PX305.10P-E2-C

Typical Patterns

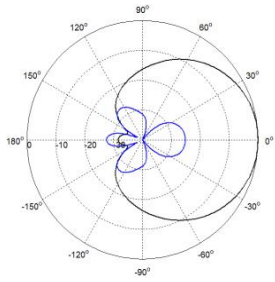

Azimuth(Low Band)

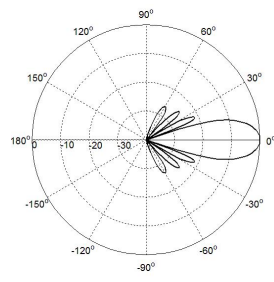

Elevation(Low Band)

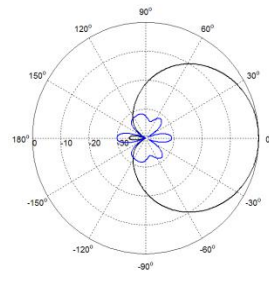

Azimuth(High Band)

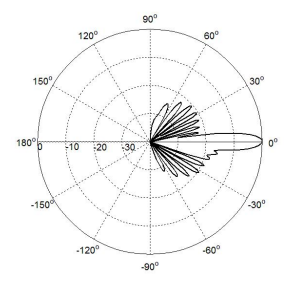

Elevation(High Band)

Correlation Table

Frequency range	Array	Connector
698– 960 MHz	R1	1-2
1710–2690 MHz	Y1	3-4
1710–2690 MHz	Y2	5-6

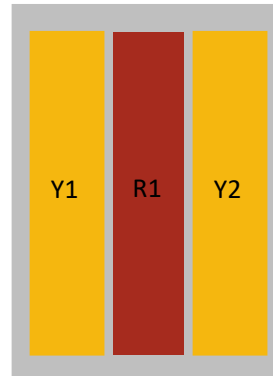

Product Data Sheet

UL2PX306.12P-2C

XXX Pol Panel Antenna 698-960/2×1710-2690MHz 65°/65° 15.5/18dBi 2°-12°/2°-12° Replaceable RET

Electrical Specifications

Frequency Range (MHz):	698-960(R1)			2×1710-2690(Y1,Y2)		
	698-806	806-880	880-960	1710-2170	2300-2490	2490-2690
Gain (dBi):	14.2±0.5	14.8±0.5	15±0.5	16.8±0.5	17.5±0.5	17.8±0.5
Return Loss (dB):	>14 (VSWR<1.5)					
Polarization:	±45°					
Horizontal 3dB Beamwidth (°):	69±5	67±5	65±5	69±5	63±5	58±5
Vertical 3dB Beamwidth (°):	13.5	12	11.0	6	5	4.5
Electrical Downtilt (°):	2-12 Independently Continuously Adjustable			2-12 Independently Continuously Adjustable		
RET Type:	Cascade SRET, AISG 2.0, Upgradeable					
1 st Upper Sidelobe Suppression (dB):	15	15	15	15	15	15
Front to Back Ratio (dB):	22	23	24	25	25	25
Cross Polar Ratio 0°(dB):	15	15	15	15	15	15
Intraband Isolation (dB):	>25			>28		
Interband Isolation (dB):	>28					
Max. Power Per Port (W):	250			200		
Intermodulation IM3 (dBc):	<-150(2×43 dBm)					
Impedance (ohm):	50					
Lightning Protection:	DC Grounded					
Connector Type:	6×4.3-10 Female					

BASTA Electrical Specification

Frequency Range(MHz):	698-960(R1)			1710-2690(Y1,Y2)		
	698-806	806-880	880-960	1710-2170	2300-2490	2490-2690
Average Gain by all Beam Tilts (dBi):	14.0	14.4	14.6	16.9	17.5	17.6
Gain by all Beam Tilts Tolerance(dB):	±0.6	±0.4	±0.4	±0.6	±0.6	±0.5
Average Gain by Beam Tilt (dBi):	2° 14.0	2° 14.5	2° 14.8	2° 17	2° 17.5	2° 17.8
	7° 14.2	7° 14.6	7° 14.8	7° 17.1	7° 17.7	7° 17.8
	12° 13.9	12° 14.2	12° 14.3	12° 16.7	12° 17.2	12° 17.2
Horizontal Beamwidth Tolerance(°):	±1.5	±1.2	±1.4	±5.9	±5.2	±5.3
Vertical Beamwidth Tolerance(°):	±0.9	±0.8	±0.7	±0.7	±0.5	±0.3
USLS to 20° above beampeak(dB):	15.1	15.4	15.9	16.8	16.5	15.2
Front to back Ratio at 180° ± 30°(dB)	24.1	24.6	24.3	26.1	26.8	26.6
CPR at Boresight(dB):	21.4	25.4	21.8	19.7	18.3	18.1

Mechanical Data

Antenna Dimensions (mm):	1795×339×169
Packing Dimensions (mm):	2065×425×260
Antenna Net Weight/Bracket (kg):	21.2/5.9
Antenna Gross Weight (kg):	31
Radome Material:	Fiberglass
Pipe OD (mm):	50-115
Mounting Kits (Included):	BA.K.04.00069101, Adjustable Downtilt 0°-12°

Environmental Ratings

Humidity:	95%RH@+30℃
Temperature (℃):	-40~+70
Wind Load @150 km/h (N):	Frontal/Lateral/Rearside: 780/259/950
Max. Wind velocity(km/h):	200

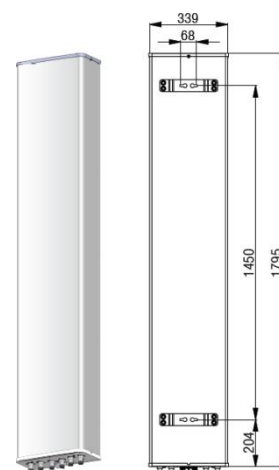

UL2PX306.12P-2C

Internal RET Specifications

RET Type:	Replaceable RET
RET protocol:	AISG2.0 /3GPP
Input voltage range(V):	10-30 DC
Power consumption(W):	< 5 (motor activated, single RET) < 1 (stand by, single RET), < 1.5 (stand by, 12V)
Adjustment time (full range) (s):	< 120 (typically, depending on antenna type)
RET connector:	1 pair of AISG 5 pin male & female
Pin assignment according AISG:	8 pin circular connector conforming to IEC 60130-9 - Ed. 3.0
Lightning protection (kA):	5 (8/20 μs Differential mode), 8 (8/20 μs Common mode)

Typical Patterns

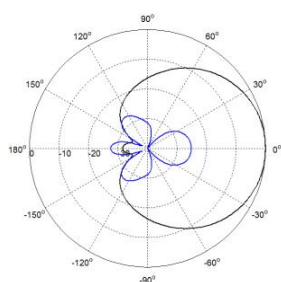

Azimuth(Low Band)

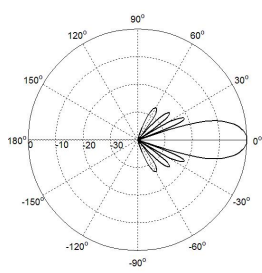

Elevation(Low Band)

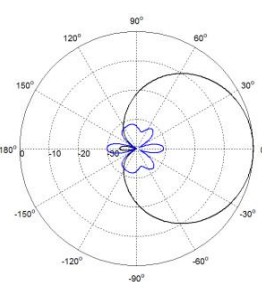

Azimuth(High Band)

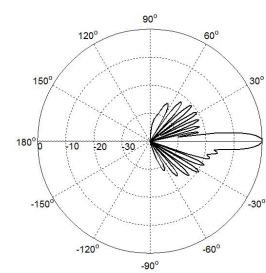

Elevation(High Band)

Bottom View

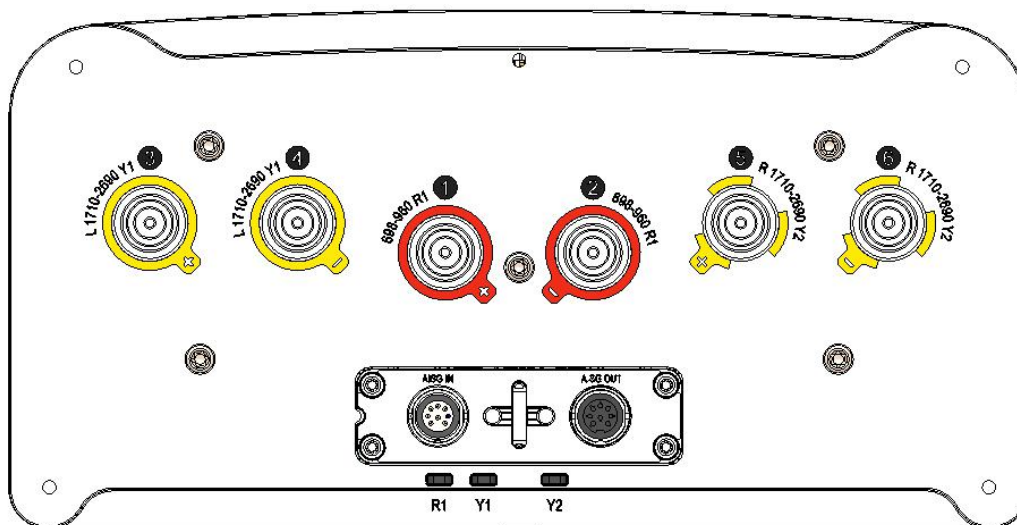

Correlation Table

Frequency range	Array	Connector	RET S/N
698– 960 MHz	R1	1-2	BRxxx.....1R1
1710–2690 MHz	Y1	3-4	BRxxx.....2Y1
1710–2690 MHz	Y2	5-6	BRxxx.....3Y2

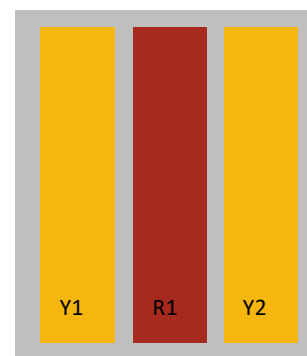

Product Data Sheet

UL2PX309.12P-V1-C

XXX Pol Panel Antenna 698-960/2×1710-2690MHz 65°/65° 17/18dBi 0°-10°Replaceable RET

Electrical Specifications

Frequency Range (MHz):	698-960(R1)			2×1710-2690 (Y1,Y2)		
	698-806	806-880	880-960	1710-2170	2300-2490	2490-2690
Gain (dBi):	15.7±0.5	16.2±0.5	16.5±0.5	16.8±0.5	17.5±0.5	17.8±0.5
Return Loss (dB):	>14 (VSWR<1.5)					
Polarization:	±45°					
Horizontal 3dB Beamwidth (°):	70±5	68±5	66±5	68±5	62±5	58±5
Vertical 3dB Beamwidth (°):	9.0	8.0	7.0	6.5	5.0	4.5
Electrical Downtilt (°):	0-10 Independently Continuously Adjustable			0-10 Independently Continuously Adjustable		
RET Type:	Cascade SRET, AISG 2.0, Upgradeable					
1 st Upper Sidelobe Suppression (dB):	15	15	15	15	15	15
Front to Back Ratio (dB):	22	23	24	25	25	25
Cross Polar Ratio 0°(dB):	15	15	15	15	15	15
Intraband Isolation (dB):	>26			>28		
Interband Isolation (dB):	>28					
Max. Power Per Port (W):	250			200		
Intermodulation IM3 (dBc):	<-150(2×43 dBm)					
Impedance (ohm):	50					
Lightning Protection:	DC Grounded					
Connector Type:	6×4.3-10 Female					

BASTA Electrical Specification

Frequency Range(MHz):	698-960(R1)			1710-2690(Y1,Y2)		
	698-806	806-880	880-960	1710-2170	2300-2490	2490-2690
Average Gain by all Beam Tilts (dBi):	15.4	15.9	16.2	16.9	17.4	17.5
Gain by all Beam Tilts Tolerance(dB):	±0.6	±0.4	±0.4	±0.6	±0.6	±0.5
Average Gain by Beam Tilt (dBi):	0° 15.4	0° 15.9	0° 16.2	0° 16.9	0° 17.4	0° 17.6
	5° 15.5	5° 16.1	5° 16.5	5° 17.2	5° 17.6	5° 17.8
	10° 15.3	10° 15.6	10° 15.8	10° 16.7	10° 17.2	10° 17.3
Horizontal Beamwidth Tolerance(°):	±2.6	±1.6	±1.3	±6.1	±5.1	±5.3
Vertical Beamwidth Tolerance(°):	±0.7	±0.6	±0.5	±0.6	±0.5	±0.4
USLS to 20° above beampeak(dB):	15.8	15.2	15.9	16.4	16.2	15.3
Front to back Ratio at 180° ± 30°(dB)	24.4	25.6	25.3	26.4	26.3	26.3
CPR at Boresight(dB):	21.2	20.4	21.1	19.2	18.6	18.3

Mechanical Data

Antenna Dimensions (mm):	2495×339×169
Packing Dimensions (mm):	2755×420×255
Antenna Net Weight/Bracket (kg):	27.2/5.9
Antenna Gross Weight (kg):	38.5
Radome Material:	Fiberglass
Pipe OD (mm):	50-115
Mounting Kits (Included):	BA.K.04.00069091, Adjustable Downtilt 0°-10°

Environmental Ratings

Humidity:	95%RH@+30°C
Temperature (°C):	-40~+70
Wind Load @150 km/h (N):	Frontal/Lateral/: 1099/382/1338
Max. Wind velocity(km/h):	200

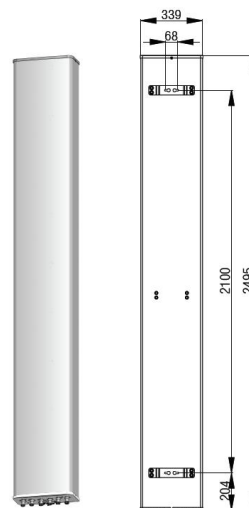

UL2PX309.12P-V1-C

Internal RET Specifications

RET Type:	Replaceable RET
RET protocol:	AISG2.0 /3GPP
Input voltage range(V):	10-30 DC
Power consumption(W):	< 5 (motor activated, single RET) < 1 (stand by, single RET), < 1.5 (stand by, 12V)
Adjustment time (full range) (s):	< 120 (typically, depending on antenna type)
RET connector:	1 pair of AISG 5 pin male & female
Pin assignment according AISG:	8 pin circular connector conforming to IEC 60130-9 - Ed. 3.0
Lightning protection (kA):	5 (8/20 μs Differential mode), 8 (8/20 μs Common mode)

Typical Patterns

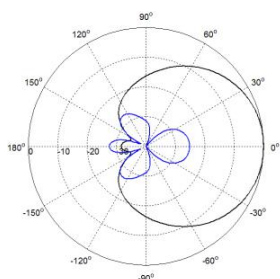

Azimuth(Low Band)

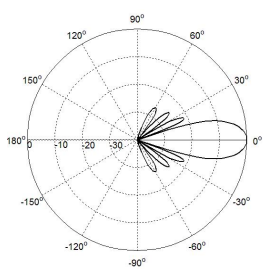

Elevation(Low Band)

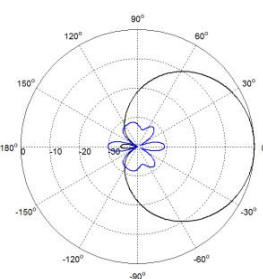

Azimuth(High Band)

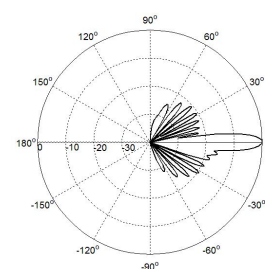

Elevation(High Band)

Bottom View

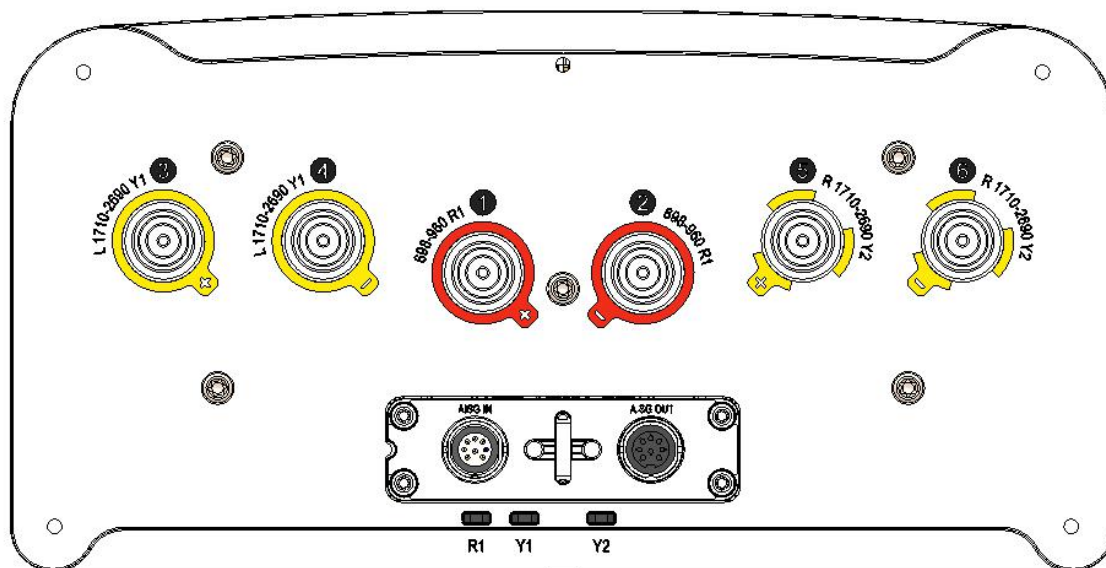

Correlation Table

Frequency range	Array	Connector	RET S/N
698– 960 MHz	R1	1-2	BRxxx.....1R1
1710–2690 MHz	Y1	3-4	BRxxx.....2Y1
1710–2690 MHz	Y2	5-6	BRxxx.....3Y2

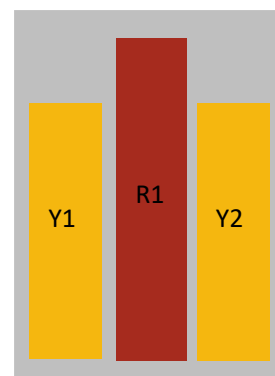

Product Data Sheet

U2LPX307.10P-E2-C

XXX Pol Panel Antenna 2×698-960/1710-2690MHz 65°/65° 15.5/17.5dBi 2°-12°/2°-12° Replaceable RET

Electrical Specifications

Frequency Range (MHz):	698-960(R1,R2)			1710-2690(Y1)		
	698-806	806-880	880-960	1710-2170	2300-2490	2490-2690
Gain (dBi):	14.3±0.5	14.8±0.5	15.3±0.5	16.3±0.5	17.3±0.5	17.0±0.5
Return Loss (dB):	>14 (VSWR<1.5)					
Polarization:	±45°					
Horizontal 3dB beamwidth (°):	70	65	60	68	62	58
Vertical 3dB beamwidth (°):	11.0	10.5	9.5	7.5	6.0	5.3
Electrical Downtilt (°):	2-12 Independently Continuously Adjustable			2-12 Independently Continuously Adjustable		
RET Type:	Cascade SRET, AISG 2.0, Upgradeable					
1 st Upper Sidelobe Level (dB):	15	15	15	15	15	15
Front to Back Ratio @180±30°(dB):	22	23	24	25	25	25
Cross Polar Ratio 0° (dB):	15	15	15	15	15	15
Cross Polar Ratio 60° (dB):	10	9	8	9	8	7
Intraband Isolation (dB):	>25					
Interband Isolation (dB):	>28					
Max. Power Per Port (W):	250			200		
Intermodulation IM3 (dBC):	<-150 (2×43 dBm)					
Impedance (ohm):	50					
Lightning Protection:	DC Grounded					
Connector Type:	6×4.3-10 Female					

Mechanical Data

Antenna Dimensions (mm):	1820×448×185
Packing Dimensions (mm):	2090×535×280
Antenna Net Weight/Bracket (kg):	28.5/5.9
Antenna Gross Weight (kg):	39.5
Radome Material:	Fiberglass
Pipe OD (mm):	50-115
Mounting Kits (Included):	BA.K.04.00069101, Adjustable Downtilt 0°-12°

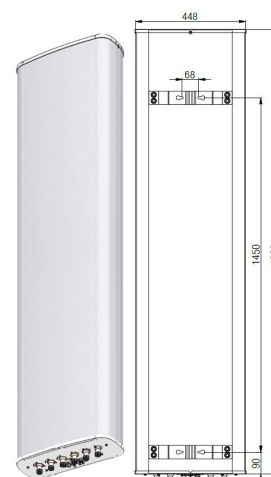

Environmental Ratings

Humidity:	95%RH@+30°C
Temperature (°C):	-50~+60
Wind Load @150 km/h (N):	Frontal/Lateral/Rearside: 784/193/930
Max. Wind velocity(km/h)	200

Internal RET Specifications

RET type:	Replaceable RET
RET protocol:	AISG2.0 /3GPP
Input voltage range(V):	10-30 DC
Power consumption(W):	< 5 (motor activated , single RET) < 1 (stand by, single RET), < 1.5 (stand by, 12V)
Adjustment time (full range) (s):	< 120 (typically, depending on antenna type)
RET connector:	1 pair of AISG 5 pin male & female
Pin assignment according AISG:	8 pin circular connector conforming to IEC 60130-9 - Ed. 3.0
Lightning protection (kA):	5 (8/20 μs Differential mode), 8 (8/20 μs Common mode)

U2LPX307.10P-E2-C

Typical Patterns

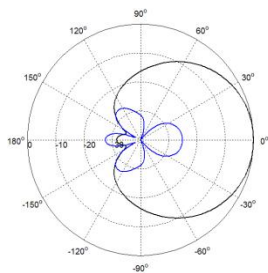

Azimuth(Low Band)

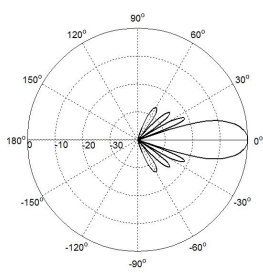

Elevation(Low Band)

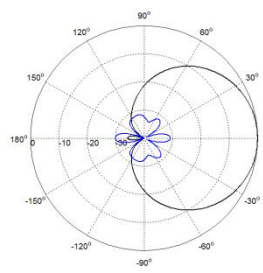

Azimuth(High Band)

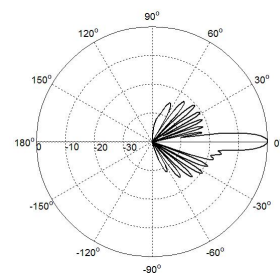

Elevation(High Band)

Bottom View

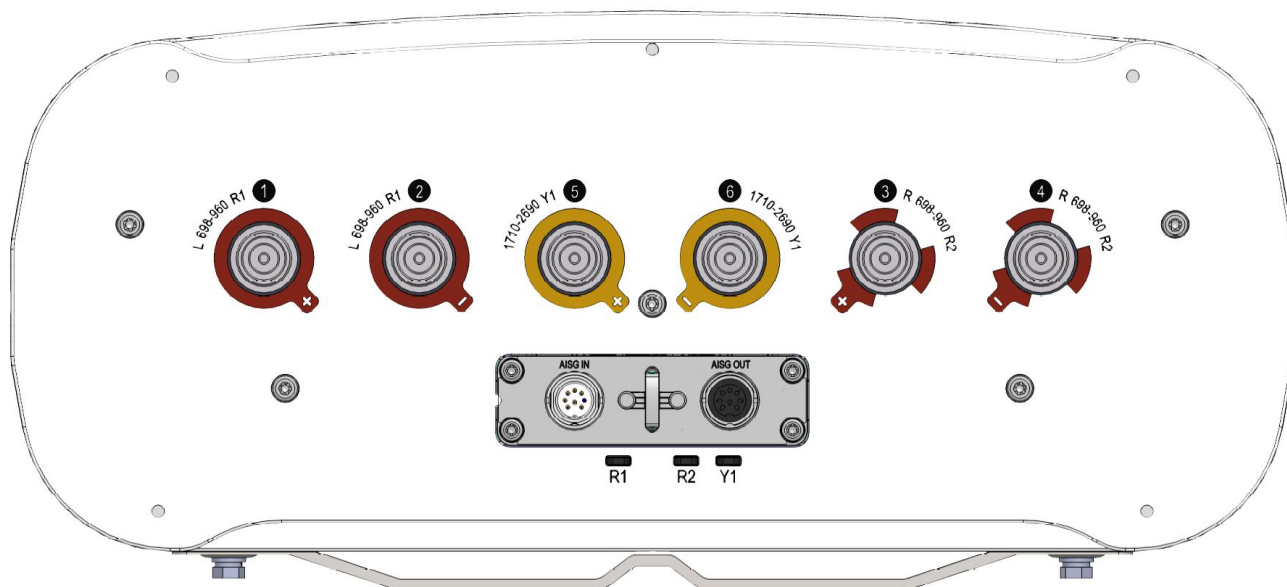

Correlation Table

Frequency range	Array	Connector
698–960 MHz	R1	1-2
698–960 MHz	R2	3-4
1710–2690 MHz	Y1	5-6

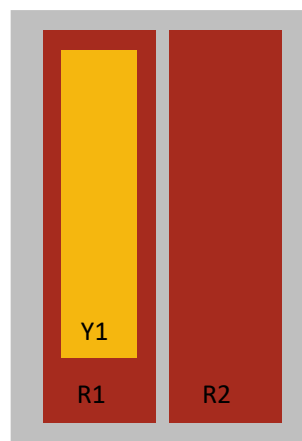

Product Data Sheet

U2LPX309.10P-E2-C

XXX Pol Panel Antenna 2×698-960/1710-2690MHz 65°/65° 17/17.5dBi 2°-12°/2°-12° Replaceable RET

Electrical Specifications

Frequency Range (MHz):	698-960(R1,R2)			1710-2690(Y1)		
	698-806	806-880	880-960	1710-2170	2300-2490	2490-2690
Gain (dBi):	15.5±0.5	16.0±0.5	16.5±0.5	16.3±0.5	17.3±0.5	17.0±0.5
Return Loss (dB):	>14 (VSWR<1.5)					
Polarization:	±45°					
Horizontal 3dB beamwidth (°):	69	64	60	69	62	58
Vertical 3dB beamwidth (°):	8.5	7.0	6.5	7.5	6.0	5.3
Electrical Downtilt (°):	2-12 Independently Continuously Adjustable			2-12 Independently Continuously Adjustable		
RET Type:	Cascade SRET, AISG 2.0, Upgradeable					
1 st Upper Sidelobe Level (dB):	15	15	15	15	15	15
Front to Back Ratio @180±30°(dB):	22	23	24	25	25	25
Cross Polar Ratio 0° (dB):	15	15	15	15	15	15
Intraband Isolation (dB):	>25					
Interband Isolation (dB):	>28					
Max. Power Per Port (W):	250			200		
Intermodulation IM3 (dBc):	<-150 (2×43 dBm)					
Impedance (ohm):	50					
Lightning Protection:	DC Grounded					
Connector Type:	6×4.3-10 Female					

Mechanical Data

Antenna Dimensions (mm):	2250×448×185
Packing Dimensions (mm):	2520×535×280
Antenna Net Weight/Bracket (kg):	34/5.9
Antenna Gross Weight (kg):	45.5
Radome Material:	Fiberglass
Pipe OD (mm):	50-115
Mounting Kits (Included):	BA.K.04.00069291, Adjustable Downtilt 0°-8°

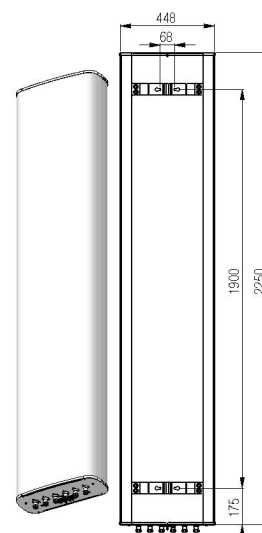

Environmental Ratings

Humidity:	95%RH@+30°C
Temperature (°C):	-50~+60
Wind Load @150 km/h (N):	Frontal/Lateral/Rearside: 978/244/1160
Max. Wind velocity(km/h)	200

Internal RET Specifications

RET type:	Replaceable RET
RET protocol:	AISG2.0 /3GPP
Input voltage range(V):	10-30 DC
Power consumption(W):	< 5 (motor activated , single RET) < 1 (stand by, single RET), < 1.5 (stand by, 12V)
Adjustment time (full range) (s):	< 120 (typically, depending on antenna type)
RET connector:	1 pair of AISG 5 pin male & female
Pin assignment according AISG:	8 pin circular connector conforming to IEC 60130-9 - Ed. 3.0
Lightning protection (kA):	5 (8/20 μs Differential mode), 8 (8/20 μs Common mode)

U2LPX309.10P-E2-C

Typical Patterns

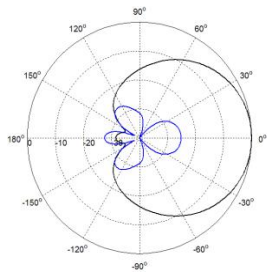

Azimuth(Low Band)

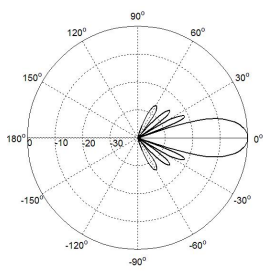

Elevation(Low Band)

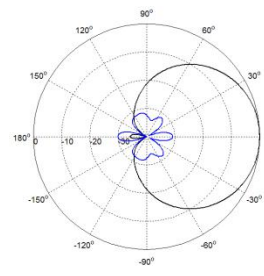

Azimuth(High Band)

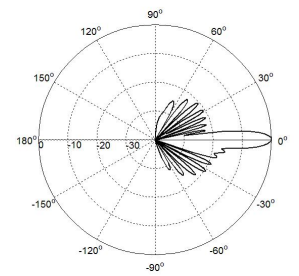

Elevation(High Band)

Correlation Table

Frequency range	Array	Connector	RET S/N
698– 960MHz	R1	1-2	BRxxx.....1R1
698– 960MHz	R2	3-4	BRxxx.....2R2
1710–2690MHz	Y1	5-6	BRxxx.....3Y1

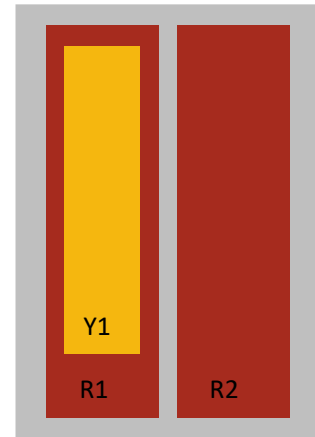

Product Data Sheet

LLVVPX201F0-4P-C

XXXX Pol Panel Antenna 1710-2690/1710-2690/3300-3800/3300-3800MHz 25° 13.5/13.5/13/13dBi
FET

Electrical Specifications

Frequency Range (MHz):	1710-2690(Y1,Y2)		3300-3800(P1,P2)
	1710-2200	2200-2690	3300-3800
Gain (dBi):	11.5	13	13
Return Loss (dB):	>14(VSWR<1.5)		
Polarization:	±45°		
Horizontal 3dB Beamwidth (°)	25	20	20
Vertical 3dB Beamwidth (°):	70	59	59
Electrical Downtilt (°):	0 Fixed		
Front to Back Ratio (dB):	>25		
Horizontal Sidelobe Suppression (dB):	>16		
Cross Polar Ratio 0° (dB):	>17		
Isolation Port to Port (dB):	>23		
Intermodulation IM3 (dBC):	<-150 (2×43 dBm)		
Max. Power Per Port (W):	200		200
Impedance (ohm):	50		
Lightning Protection:	DC Grounded		
Connector Type:	4×4.3-10 Female		

BASTA Electrical Specification

Frequency Range (MHz):	1710-2690(Y1,Y2)		3300-3800(P1,P2)
	1710-2200	2200-2690	3300-3800
Average Gain by all Beam Tilts (dBi):	11.5	13.1	13
Gain by all Beam Tilts Tolerance (dB):	±0.5	±0.5	±2
3dB Horizontal Beamwidth Tolerance (°):	±3.0	±2.0	±3.0
3dB Vertical Beamwidth Tolerance (°):	±3.0	±5.0	±6.5
Horizontal Sidelobe Suppression (dB):	16	16	16
Front to back Total Power at 180° ± 30° (dB):	25	25	24
CPR at Boresight (dB):	16	18	18

Mechanical Data

Antenna Dimensions (mm):	600×300×110
Packing Dimensions (mm):	885x400x255
Antenna Net Weight/Bracket (kg):	6.5/4
Antenna Gross Weight (kg):	12
Radome Material:	ASA, UV Resistant
Pipe OD (mm):	70-114
Mounting Kits (Included):	BA.K.04.00069041, Horizontal adjustable ±40° Vertical adjustable ±40°

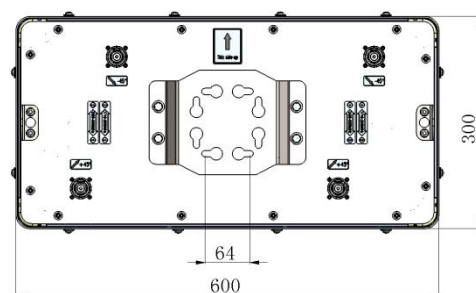
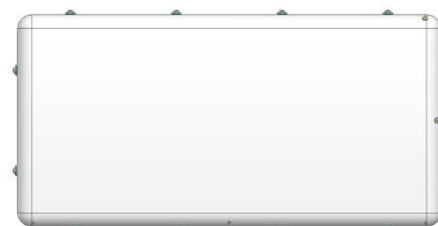

Environmental Ratings

Humidity:	95%RH@+30°C
Temperature (°C):	-40~+60
Wind Load @150 km/h (N):	Frontal/ Lateral/ Rearside: 305/50/351
Max. Wind velocity (km/h)	200

LLVVPX201F0-4P-C

Typical Patterns

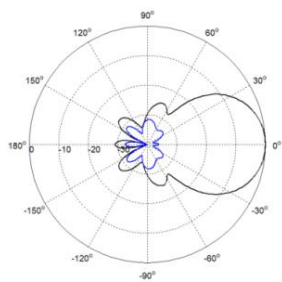

Azimuth

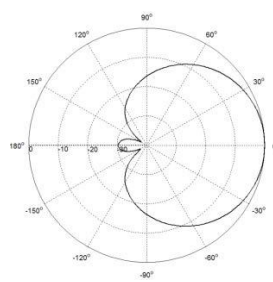

Elevation

Correlation Table

Frequency range	Array	Connector
1710-2690MHz	Y1	1-2
1710-2690MHz	Y2	3-4
3300-3800MHz	P1	1-2
3300-3800MHz	P2	3-4

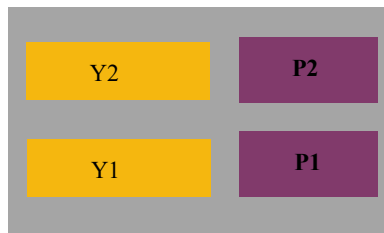

Product Data Sheet

LLVVPX203F0-4P-N

XXXX Pol Panel Antenna 2×1710-2690/2×3300-3800MHz 33°/33° 12/13dBi 0°FET

Electrical Specifications

Frequency Range (MHz):	1710-2170(Y1,Y2)		3300-3800(P1,P2)		
	1710-1880	1880-2170	3300-3400	3500-3600	3700-3800
Gain (dBi):	13.7±0.3	14.1±0.5	13.1±0.5	13.4±0.5	13.1±0.4
Return Loss (dB):	VSWR<1.5		VSWR<1.5		
Polarization:	±45°				
Horizontal 3dB Beamwidth(°):	35	32	30	29.	29
Vertical 3dB Beamwidth(°):	35	32	33	33	34
Horizontal 3dB to 20dB angle difference(°):	≤23	≤21	≤22	≤21	≤22
Vertical 3dB to 20dB angle difference(°):	≤27	≤21	≤23	≤22	≤22
Electrical Downtilt(°):	0 Fixed				
Front to Back Ratio (dB):	25	25	25	25	25
Vertical Sidelobe Suppression(dB):	18	18	18	18	18
Horizontal Sidelobe Suppression(dB):	18	18	18	18	18
CPR at Boresight	17	17	17	17	17
Isolation(dB):	>25		>25		
Max. Power Per Port (W):	150		100		
Intermodulation IM3 (dBC):	<-150(2×43dBm)				
Impedance (ohm):	50				
Lightning Protection:	DC Grounded				
Connector Type:	4×N Female				

BASTA Electrical Specification

Frequency Range(MHz):	1710-1880	1880-2170	3300-3400	3500-3600	3700-3800
Average Gain by all Beam Tilts(dBi): (dBi):	13.7	14.1	13.1	13.4	13.1
Gain by all Beam Tilts Tolerance(dB):	±0.3	±0.5	±0.5	±0.5	±0.4
3dB Horizontal Beamwidth Tolerance(°):	±1.1	±2.8	±1.9	±1.8	±1.5
3dB Vertical Beamwidth Tolerance(°):	±2.8	±1.4	±1.2	±1.3	±1.5
USLS beampeak to 90° above beampeak(dB):	20.9	21.8	19.3	20.9	18.1
USLS beampeak to 90° above beampeak(dB):	20.8	19.5	19.8	21.7	18.2
Front to back Total Power at 180° ± 30°(dB)	30.5	31.2	31.4	29.3	28.7
CPR at Boresight(dB):	21.4	22.7	20.2	21.9	19.1

Product Data Sheet

LLVVPX203F0-4P-N

Mechanical Data

Antenna Dimensions (mm):	540×420×110
Packing Dimensions (mm):	745×520×255
Antenna Net Weight /Bracket (kg):	9.8/2.6
Antenna Gross Weight (kg):	13.2
Radome Material:	ASA, UV Resistant
Pole Diameter (mm):	50-100
Mounting Kits (Included):	BA.K.04.00069581, Horizontal adjustable ±35° Vertical adjustable ±50°

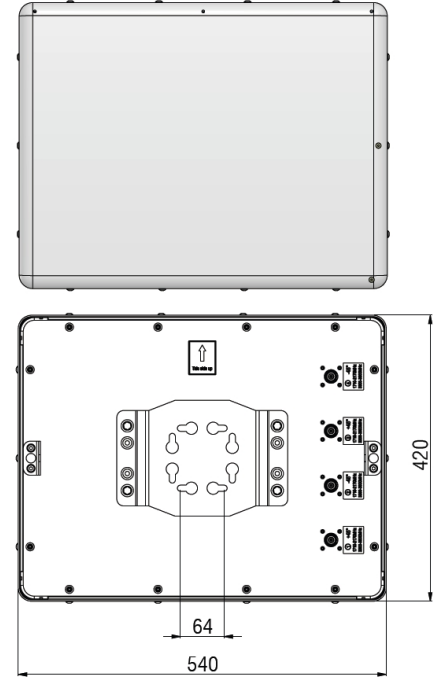

Environmental Ratings

Humidity:	95%RH@+30°C
Temperature (°C):	-40~+60
Wind Load @150 km/h (N):	Frontal/Lateral/Rearside: 280/38/327
Max. Wind velocity(km/h):	200

Typical Patterns

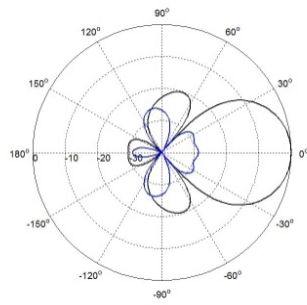

Azimuth(Low Band)

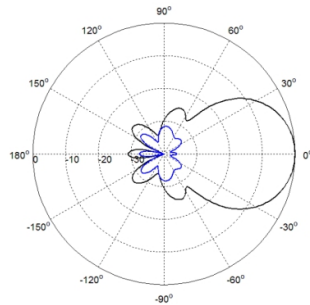

Elevation(Low Band)

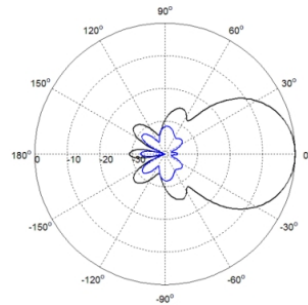

Azimuth(High Band)

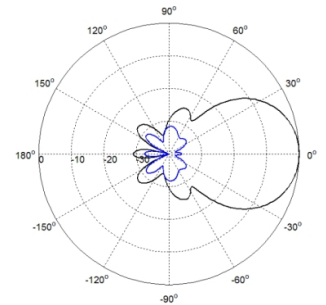

Elevation(High Band)

Correlation Table

Frequency range	Array	Connector
1710–2690 MHz	Y1	1-2
1710–2690 MHz	Y2	3-4
3300–3800 MHz	P1	1-2
3300–3800 MHz	P2	3-4

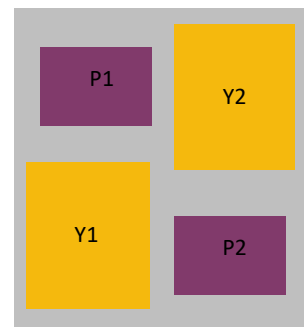

Product Data Sheet

ULVVPX201F0-4P

XXXX Pol Panel Antenna 698-960/1710-2700/3300-3800/3300-3800MHz 20° 11/12/12/11.5dBi FET

Electrical Specifications

Frequency Range (MHz):	698-960		1710-2700		3300-3800	3300-3800
	698-800	800-960	1710-2200	2200-2700		
Gain (dBi):	10.5±0.5	11.5±0.5	11±0.5	12±0.5	11.5±0.5	12±0.5
Return Loss (dB):	>14 (VSWR<1.5)					
Polarization (°):	±45					
Horizontal 3dB beamwidth (°):	25±5	25±5	25±5	20±5	20±5	20±5
Vertical 3dB beamwidth (°):	65±5	65±5	65±5	60±5	60±8	60±8
Electrical Downtilt (°):	0 Fixed					
Horizontal Sidelobe Suppression (dB):	≥19	≥19	≥19	≥18	≥19	≥19
Front to Back Ratio (dB):	≥25	≥25	≥25	≥25	≥25	≥25
Cross Polar Ratio 0° (dB):	≥17	≥17	≥17	≥17	≥17	≥17
Isolation Port to Port(dB):	≥23					
Max. Power Per Port (W):	200					
Intermodulation IM3 (dBc):	<-150 (2×43 dBm)					
Impedance (ohm):	50					
Lightning Protection:	DC Grounded					
Connector Type:	4×7/16DINFemale					

BASTA Electrical Specifications

Frequency Range(MHz):	698-960	1710-2700	3300-3800
Average Gain by all Beam Tilts (dBi):	11.7	12.8	12
Gain by all Beam Tilts Tolerance(dB):	±0.4	±0.7	±0.8
Average Gain by Beam Tilt (dBi):	0° 11.7	0° 12.8	0° 12
Horizontal Beamwidth Tolerance(°):	±4	±5	±2
Vertical Beamwidth Tolerance(°):	±2.5	±3.8	±4.3
USLS beampeak to 20° above beampeak(dB):	20.0	17.4	17.8
Front to back Total Power at 180° ± 30°(dB)	26.8	32.6	26.8
CPR at Boresight(dB):	16.3	16.8	21.4
CPR at Sector(dB):	11.2	10.8	10.6

Mechanical Data

Antenna Dimensions (mm):	806 x 460 x 135
Packing Dimensions (mm):	1150x655x205
Antenna Net Weight/Bracket (kg):	11.5/6.2
Antenna Gross Weight (kg):	22
Radome Material:	ASA
Pipe OD (mm):	70-114
Mounting Kits (Included):	BA.K.04.00048 horizontal adjustable -45°-+45° vertical adjustable-45°-+45°

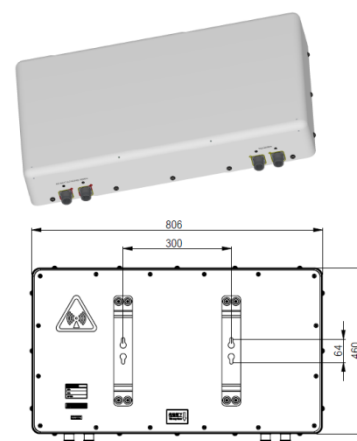

Environmental Ratings

Humidity:	95%RH@+30°C
Temperature (°C):	-40~+70
Wind Load @150 km/h (N):	Frontal/Lateral/Rearside:646/705/86
Max. Wind velocity(km/h):	200

ULVVPX201F0-4P

Typical Patterns

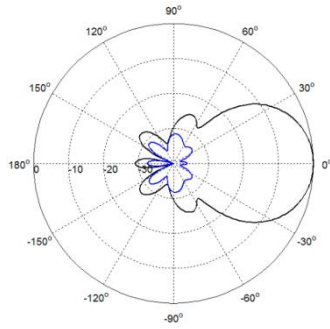

Azimuth

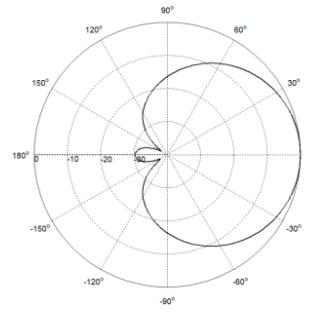

Elevation

Bottom View

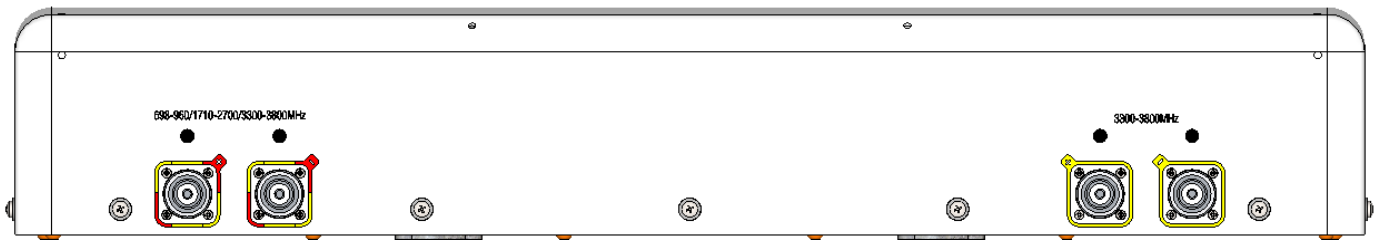

Product Data Sheet

ULVVPX201F0-6P

XXXX Pol Panel Antenna 698-960/1710-2700/3300-3800/3300-3800MHz 20° 11/12/12/12dBi FET

Electrical Specifications

Frequency Range (MHz):	698-960(R1)		1710-2700(Y1)		3300-3800	3300-3800
	698-800	800-960	1710-2200	2200-2700	(P1)	(P2)
Gain (dBi):	10.5±0.5	11.5±0.5	11±0.5	12±0.5	12±0.5	12±0.5
Return Loss (dB):	>14 (VSWR<1.5)					
Polarization:	±45°					
Horizontal 3dB beamwidth (°):	25±5	25±5	25±5	20±5	20±5	20±5
Vertical 3dB beamwidth (°):	65±8	65±8	60±8	60±8	60±8	60±8
Electrical Downtilt (°):	0 Fixed					
Horizontal Sidelobe Suppression : (dB):	≥18	≥18	≥18	≥18	≥18	≥18
Front to Back Ratio (dB):	≥25	≥25	≥25	≥25	≥25	≥25
Cross Polar Ratio 0° (dB):	≥17	≥17	≥17	≥17	≥17	≥17
Isolation Port to Port(dB):	≥23					
Max. Power Per Port (W):	200					
Intermodulation IM3 (dBc):	<-150 (2×43 dBm)				/	
Impedance (ohm):	50					
Lightning Protection:	DC Grounded					
Connector Type:	6×7/16 DIN Female					

BASTA Electrical Specifications

Frequency Range(MHz):	698-960	1710-2700	3300-3800
Average Gain by all Beam Tilts (dBi):	11.3	11.7	12.5
Gain by all Beam Tilts Tolerance(dB):	±0.4	±0.7	±0.8
Average Gain by Beam Tilt (dBi):	0° 11.3	0° 11.7	0° 12.5
Horizontal Beamwidth Tolerance(°):	±4	±5	±2
Vertical Beamwidth Tolerance(°):	±2.5	±3.8	±4.3
USLS beampeak to 20° above beampeak(dB):	21.6	20.29	20.38
Front to back Total Power at 180° ± 30°(dB)	28.4	29.33	30.5
CPR at Boresight(dB):	23.9	23.09	23.44
CPR at Sector(dB):	11.2	10.8	10.6

Mechanical Data

Antenna Dimensions (mm):	806x460x135
Packing Dimensions (mm):	1150x655x205
Antenna Net Weight/Bracket (kg):	11.5/6.2
Antenna Gross Weight (kg):	22
Radome Material:	ASA
Pipe OD (mm):	70-114
Mounting Kits (Included):	BA.K.04.00048, horizontal adjustable -45°-+45°, vertical adjustable-45°-+45°



Environmental Ratings

Humidity:	95%RH@+30℃
Temperature (℃):	-40~+70
Wind Load @150 km/h (N):	Frontal/ Lateral/Rearside: 646/705/86
Max. Wind velocity(km/h):	200

ULVVPX201F0-6P

Typical Patterns

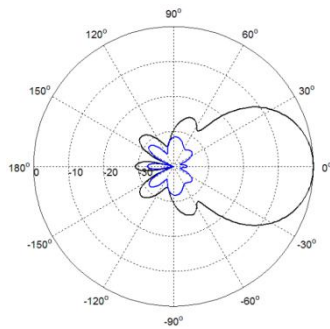

Azimuth

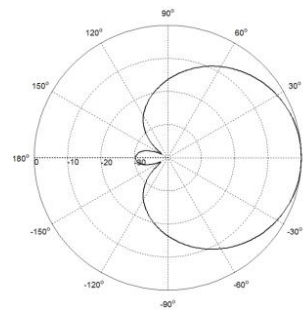

Elevation

Bottom View

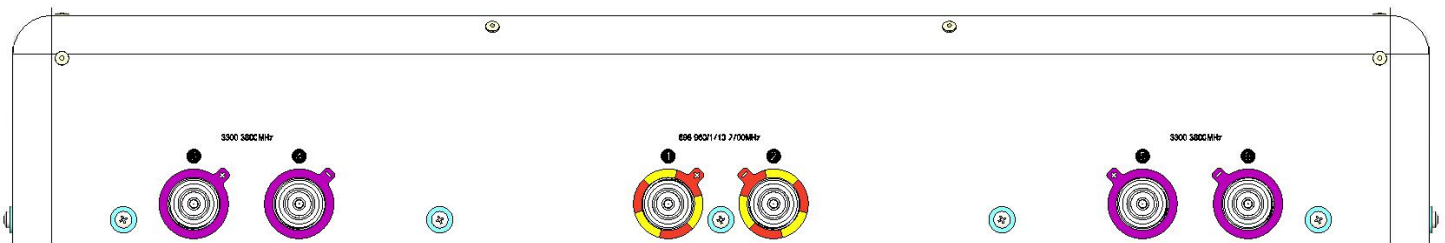

Correlation Table

Frequency range	Array	Connector
698-2700 MHz	R1/Y1	1-2
3300-3800 MHz	P1	3-4
3300-3800 MHz	P2	5-6

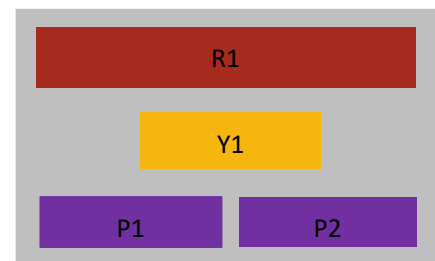

Product Data Sheet

UL2PX307.10P-DH-E2-C

XXXX Pol Panel Antenna 694-960/1710-2170/2490-2690/1710-2690MHz 65°/65°/65°/65°
16/16/17/18dBi 2°-12°/2°-10°/2°-10°/2°-10° Replaceable RET

Electrical Specifications

Frequency Range (MHz):	694-960(R1)			1710-2170(B1)			2490-2690 (Y1)
	694-806	806-880	880-960	1710-1880	1880-2025	2025-2170	2490-2690
Gain (dBi):	14.8±0.5	15.3±0.5	15.8±0.5	15.5±0.5	15.8±0.5	16.2±0.5	16.6±0.5
Return Loss (dB):	>14 (VSWR<1.5)						
Polarization:	±45°			±45°			
Horizontal 3dB Beamwidth (°):	68	65	63	68	65	63	58
Vertical 3dB Beamwidth (°):	11.0	9.5	8.5	8.0	7.5	7.0	5.5
Electrical Downtilt (°):	2-12 Independently Continuously Adjustable			2-10 Independently Continuously Adjustable			
RET Type:	Cascade SRET, AISG 2.0, Upgradeable						
1 st Upper Sidelobe Suppression (dB):	16	16	16	16	16	16	16
Front to Back Ratio(dB):	22	23	24	25	25	25	25
Cross Polar Ratio 0° (dB):	15	15	15	15	15	15	15
Intraband Isolation (dB):	>26						
Interband Isolation (dB):	>26						
Max. Power Per Port (W):	250			200			
Intermodulation IM3 (dBc):	<-150 (2×43 dBm)						
Impedance (ohm):	50						
Lightning Protection:	DC Grounded						

Electrical Specifications

Frequency Range (MHz):	1710-2690(Y2)		
	1710-2170	2300-2490	2490-2690
Gain (dBi):	16.7±0.5	17.3±0.5	17.6±0.5
Return Loss (dB):	>14(VSWR<1.5)		
Polarization:	±45°		
Horizontal 3dB Beamwidth (°):	68	65	58
Vertical 3dB Beamwidth (°):	7.5	6.0	5.5
Electrical Downtilt (°):	2-10 Independently Continuously Adjustable		
RET Type:	Cascade SRET, AISG 2.0, Upgradeable		
1 st Upper Sidelobe Suppression (dB):	16	16	16
Front to Back Ratio(dB):	25	25	25
Cross Polar Ratio 0° (dB):	15	15	15
Intraband Isolation (dB):	>28		
Interband Isolation (dB):	>28		
Max. Power Per Port (W):	200		
Intermodulation IM3 (dBc):	<-150(2×43 dBm)		
Impedance (ohm):	50		
Lightning Protection:	DC Grounded		

Product Data Sheet

UL2PX307.10P-DH-E2-C

BASTA Electrical Specification

Frequency Range(MHz):	694-862(R1)			1710-2690(Y2)		
	694-806	806-862	880-960	1710-2170	2300-2490	2490-2690
Average Gain by all Beam Tilts (dBi):	14.8	15.3	15.5	16.5	17.0	17.3
Gain by all Beam Tilts Tolerance(dB):	±0.6	±0.5	±0.5	±0.5	±0.5	±0.5
Average Gain by Beam Tilt (dBi):	2° 14.8	2° 15.0	2° 15.5	2° 16.3	2° 17.0	2° 17.3
	7° 15.0	7° 15.5	7° 15.8	6° 16.6	6° 17.2	6° 17.5
	12° 14.7	12° 15.0	12° 15.3	10° 16.1	10° 16.6	10° 17.1
Horizontal Beamwidth Tolerance(°):	±4	±3	±3	±3.5	±2.8	±2.5
Vertical Beamwidth Tolerance(°):	±2.0	±1.8	±1.5	±1.5	±1.3	±1.2
USLS to 20° above beampeak(dB):	16.4	16.7	16.8	16.2	16.0	16.9
Front to back Ratio at 180° ± 30°(dB)	23.8	25.2	25.8	25.3	25.6	26.5
CPR at Boresight(dB):	15.8	16.2	15.6	16.2	16.5	15.8

BASTA Electrical Specification

Frequency Range(MHz):	1710-2170(B1)			2490-2690(Y1)
	1710-1880	1880-2025	2025-2170	2490-2690
Average Gain by all Beam Tilts (dBi):	15.5	15.8	16.0	16.5
Gain by all Beam Tilts Tolerance(dB):	±0.5	±0.5	±0.5	±0.5
Average Gain by Beam Tilt (dBi):	2° 15.4	2° 15.5	2° 15.8	2° 16.3
	6° 15.6	6° 15.9	6° 16.2	6° 16.7
	10° 15.2	10° 15.4	10° 15.6	10° 16.1
Horizontal Beamwidth Tolerance(°):	±3.5	±2.8	±2.5	±2.5
Vertical Beamwidth Tolerance(°):	±1.5	±1.3	±1.2	±1.2
USLS to 20° above beampeak(dB):	16.8	16.5	16.7	16.2
Front to back Ratio at 180° ± 30°(dB)	25.3	25.6	26.5	26.7
CPR at Boresight(dB):	16.2	16.5	16.8	17.0

Mechanical Data

Antenna Dimensions(mm):	1960×339×169
Packing Dimensions (mm):	2300×425×260
Antenna Net Weight/Bracket(kg):	24/5.9
Antenna Gross Weight(kg):	34
Radome Material:	Fiberglass
Pipe OD (mm):	70-114
Mounting Kits (Included):	BA.K.04.00069101, Adjustable Downtilt 0°-12°
Connector Type:	8×4.3-10 Female

Environmental Ratings

Humidity:	95%RH@+30°C
Temperature (°C):	-50~+70
Wind Load @150 km/h (N):	Frontal/Lateral/Rearside: 1182/351/1379
Max. Wind velocity(km/h):	200

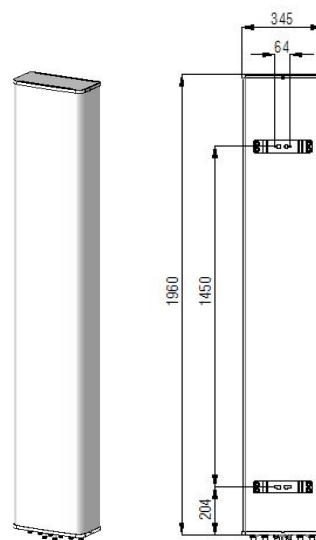

UL2PX307.10P-DH-E2-C

Internal RET Specifications

RET Type:	Replaceable RET
RET protocol:	AISG 2.0 /3 GPP
Input voltage range(V):	10-30 DC
Power consumption(W):	< 5 (motor activated, single RET) < 1 (stand by, single RET), < 1.5 (stand by, 12V)
Adjustment time (full range) (s):	< 120 (typically, depending on antenna type)
RET connector:	1 pair of AISG 5 pin male & female
Pin assignment according AISG:	8 pin circular connector conforming to IEC 60130-9 - Ed. 3.0
Lightning protection (kA):	5 (8/20 μs Differential mode), 8 (8/20 μs Common mode)

Typical Patterns

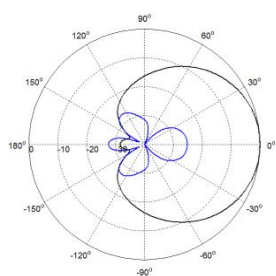

Azimuth(Low Band)

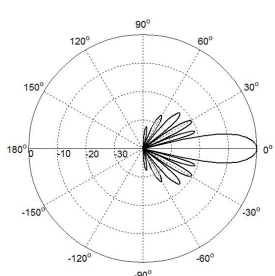

Elevation(Low Band)

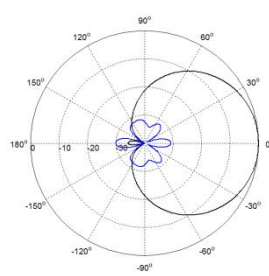

Azimuth(High Band)

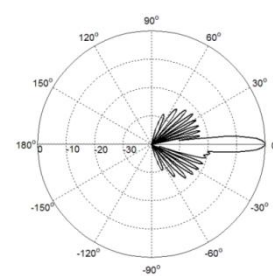

Elevation(High Band)

Bottom View

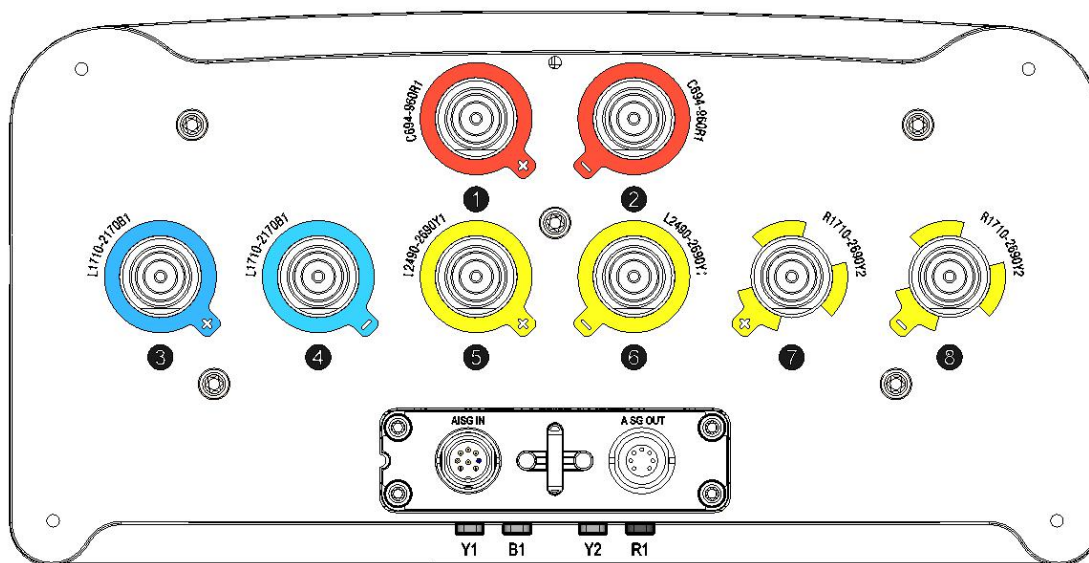

Correlation Table

Frequency range	Array	Connector	RET S/N
694-960 MHz	R1	1-2	BRxxx.....1R1
1710-2170 MHz	B1	3-4	BRxxx.....1B1
2490-2690 MHz	Y1	5-6	BRxxx.....1Y1
1710-2690 MHz	Y2	7-8	BRxxx.....1Y2

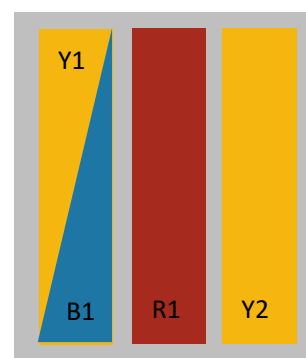

Product Data Sheet

UL2PX307.12P-DL-C

XXXX Pol Panel Antenna 698-862/880-960/2×1710-2690MHz 65°/65° /65° 15/15.5/18dBi

2°-12°/2°-12°/0°-10° Replaceable RET

Electrical Specifications

Frequency Range (MHz):	698-862(R1)		880-960(R2)	2×1710-2690 (Y1,Y2)		
	698-806	806-862	880-960	1710-2170	2300-2490	2490-2690
Gain (dBi):	14.2±0.5	14.6±0.5	15.2±0.5	16.8±0.5	17.5±0.5	17.8±0.5
Return Loss (dB):	>14 (VSWR<1.5)					
Polarization :	±45°					
Horizontal 3dB Beamwidth (°):	69	67	65	66	62	57
Vertical 3dB Beamwidth(°):	11.5	10.0	9.0	6.5	5.0	4.5
Electrical Downtilt (°):	2-12 Independently Continuously Adjustable			0-10 Independently Continuously Adjustable		
1 st Upper Sidelobe Suppression (dB):	15	15	15	15	15	15
Front to Back Ratio (dB):	22	23	24	24	25	25
Cross Polar Ratio 0°(dB):	15	15	15	15	15	15
Intraband Isolation (dB):	26					
Interband Isolation (dB):	28					
Max. Power Per Port (W):	250			200		
Intermodulation IM3 (dBc):	<-150 (2×43 dBm)					
Impedance (ohm):	50					
Lightning Protection:	DC Grounded					
Connector Type:	8×4.3-10 Female					

BASTA Electrical Specification

Frequency Range(MHz):	698-960(R1)		698-960(R2)	1710-2690(Y1)			1710-2690(Y2)		
	698-806	806-862	880-960	1710-2170	2300-2490	2490-2690	1710-2170	2300-2490	2490-2690
Average Gain by all Beam Tilts (dBi):	14.1	14.5	15.0	16.8	17.4	17.7	16.7	17.5	17.7
Gain by all Beam Tilts Tolerance(dB):	±0.3	±0.3	±0.5	±0.4	±0.6	±0.7	±0.5	±0.5	±0.6
Average Gain by Beam Tilt (dBi):	2°/0°(R1R2/Y1Y2)		15.1	16.8	17.4	17.8	16.7	17.5	17.7
	7°/5°(R1R2/Y1Y2)		15.2	16.9	17.5	17.9	16.8	17.6	17.8
	12°/10°(R1R2/Y1Y2)		14.0	14.5	14.9	16.7	17.3	17.6	16.6
Horizontal Beamwidth Tolerance(°):	±5.9	±5.9	±6.4	±9.8	±6.5	±9.0	±8.4	±5.9	±7.4
Vertical Beamwidth Tolerance(°):	±0.7	±0.7	±1.1	±0.6	±0.6	±0.4	±0.4	±0.7	±0.8
USLS to 20° above beampeak(dB):	15.7	16.2	16.4	20.1	20.5	17.6	19.2	18.4	21.2
Front to back Ratio at 180° ± 30°(dB)	23.4	24.2	24.8	25.3	26.5	26.4	26.4	25.9	25.7
CPR at Boresight(dB):	19.0	18.2	17.4	16.5	18.1	17.6	17.2	17.3	19.4



Product Data Sheet

UL2PX307.12P-DL-C

Mechanical Data

Antenna Dimensions (mm):	1995×396×190
Packing Dimensions (mm):	2255×480×280
Antenna Net Weight/bracket (kg):	28.5/5.9
Antenna Gross Weight (kg):	39.5
Radome Material:	Fiberglass
Pipe OD (mm):	50-115
Mounting Kits (Included):	BA.K.04.00069121, Adjustable Downtilt 0°-14°

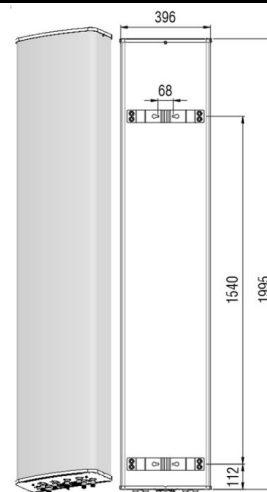

Environmental Ratings

Humidity:	95%RH@+30°C
Temperature (°C):	-40~+70
Wind Load @150 km/h (N):	Frontal/Lateral/Rearside: 891/252/1172
Max. Wind velocity(km/h):	200

Internal RET Specifications

RET type:	Replaceable RET
RET protocol:	AISG2.0 /3GPP
Input voltage range(V):	10-30 DC
Power consumption (W):	< 5 (motor activated, single RET) < 1 (stand by, single RET), < 1.5 (stand by, 12V)
Adjustment time (full range) (s):	< 120 (typically, depending on antenna type)
RET connector:	1 pair of AISG 5 pin male & female
Pin assignment according AISG:	8pin circular connector conforming to IEC 60130-9 - Ed. 3.0
Lightning protection (kA):	5 (8/20 μs Differential mode), 8 (8/20 μs Common mode)

Typical Patterns

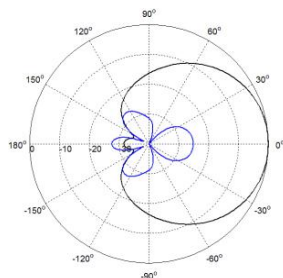

Azimuth(Low Band)

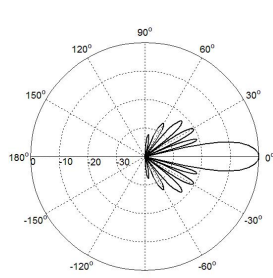

Elevation(Low Band)

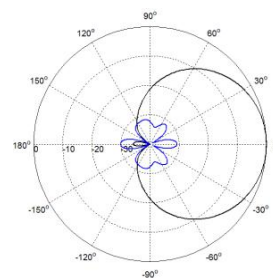

Azimuth(High Band)

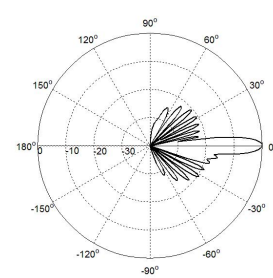

Elevation(High Band)



UL2PX307.12P-DL-C

Bottom View

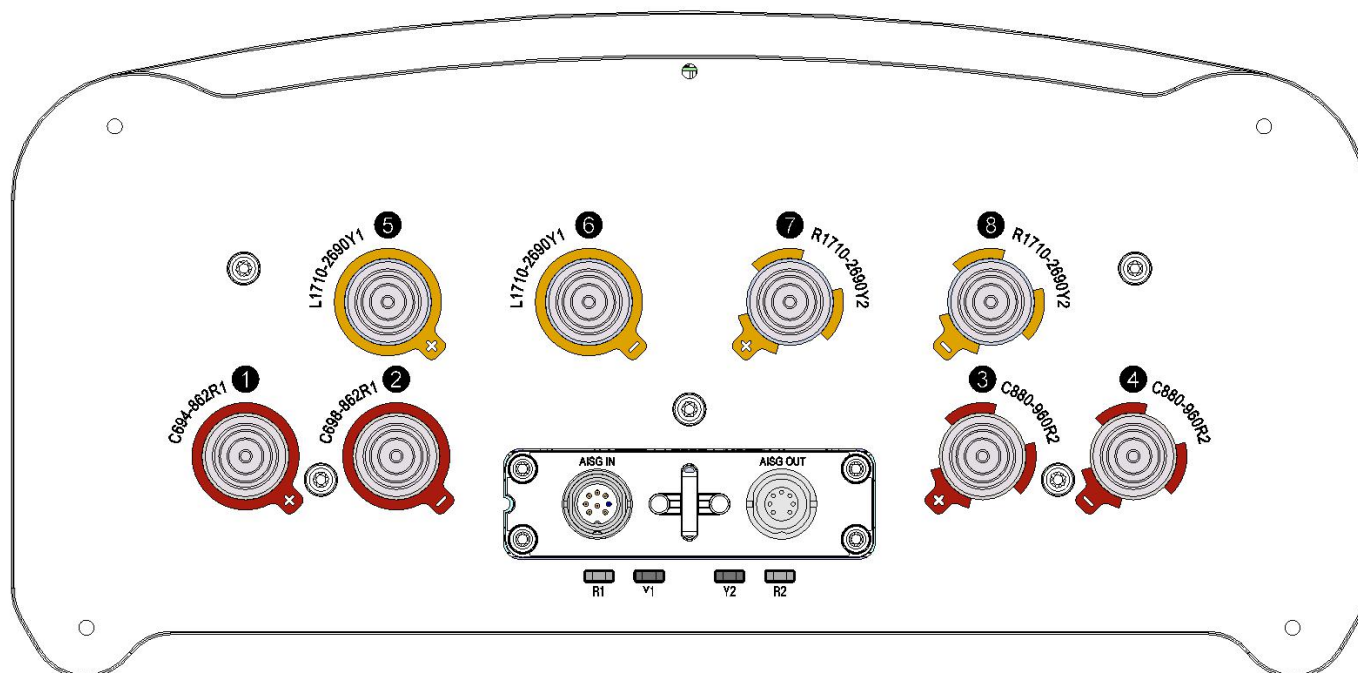

Correlation Table

Frequency range	Array	Connector	RET S/N
698– 862MHz	R1	1-2	BRxxx.....1R1
880– 960MHz	R2	3-4	BRxxx.....2R2
1710–2690MHz	Y1	5-6	BRxxx.....3Y1
1710–2690MHz	Y2	7-8	BRxxx.....4Y2

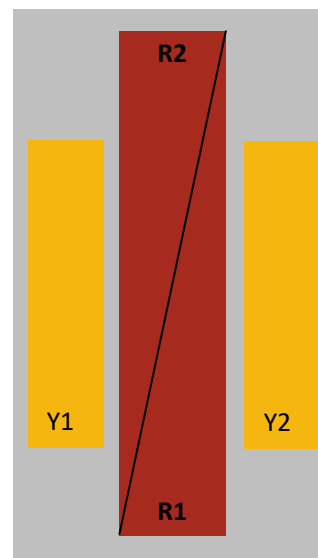

Product Data Sheet

ULLLPX305.10P-C

XXXX Pol Panel Antenna 698-960/3x1710-2690MHz 65°/65°15/17.5dBi 0°-14°/0°-10° Replaceable RET

Electrical Specifications

Frequency Range (MHz):	698-960(R1)			1710-2690(Y1,Y3)			1710-2690(Y2)		
	698-806	806-880	880-960	1710 -2170	2300 -2490	2490 -2690	1710 -2170	2300 -2490	2490 -2690
Gain (dBi):	13.5 ±0.5	13.7 ±0.5	14.2 ±0.5	16.6 ±0.5	17.2 ±0.5	17.7 ±0.5	15.8 ±0.5	16.4 ±0.5	16.8 ±0.5
Return Loss (dB):	>14 (VSWR<1.5)								
Polarization:	±45°								
Horizontal 3dB Beamwidth (°):	65	64	68	63	58	55	74	57	58
Vertical 3dB Beamwidth (°):	18	16	14	7.5	6.0	5.5	7.0	5.7	5.3
Electrical Downtilt (°):	0-14 Independently Continuously Adjustable			0-10 Independently Continuously Adjustable					
RET Type:	Cascade SRET, AISG 2.0, Upgradeable								
1 st Upper Sidelobe Suppression(dB):	14	16	15	15	16	14	15	16	14
Intraband Isolation (dB):	>26								
Interband Isolation (dB):	>28								
Max. Power Per Port (W):	250			200					
Intermodulation IM3 (dBc):	<-150 (2x43 dBm)								
Impedance (ohm):	50								
Lightning Protection:	DC Grounded								
Connector Type:	8x4.3-10 Female								

BASTA Electrical Specifications

Frequency Range(MHz):	698-960(R1)		
	698-806	806-880	880-960
Average Gain by all Beam Tilts(dBi):	13.5	13.8	13.9
Gain by all Beam Tilts Tolerance(dB):	±0.5	±0.4	±0.4
Average Gain by Beam Tilts (dBi):	0° 13.6 7° 13.4 14° 13.4	0° 13.8 7° 13.9 14° 13.7	0° 14.1 7° 14.0 14° 13.6
Horizontal Beamwidth Tolerance(°):	±2.2	±1.7	±3.5
Vertical Beamwidth Tolerance(°):	±1.5	±0.9	±0.8
Upper Side Lobe Suppression, Peak to 20°(dB):	14.0	15.5	14.9
Front to back Total Power at 180° ± 30°(dB)	21.4	25.6	26.5
CPR at Boresight(dB):	22.9	22.4	21.0
CPR at Sector(dB):	9.2	10.5	8.0

Product Data Sheet

ULLLPX305.10P-C

BASTA Electrical Specifications

Frequency Range(MHz):	1710-2690(Y1,Y3)			1710-2690(Y2)		
	1710-2170	2300-2490	2490-2690	1710-2170	2300-2490	2490-2690
Average Gain by all Beam Tilts(dBi):	16.5	17.1	17.4	15.8	16.2	16.4
Gain by all Beam Tilts Tolerance(dB):	±0.8	±0.5	±0.8	±0.3	±0.6	±0.4
Average Gain by Beam Tilts (dBi):	0° 16.8	0° 17.0	0° 17.6	0° 15.9	0° 16.6	0° 16.6
	5° 16.7	5° 17.5	5° 17.7	5° 16.0	5° 16.3	5° 16.7
	10° 16.0	10° 16.9	10° 16.7	10° 15.6	10° 15.6	10° 16.0
Horizontal Beamwidth Tolerance(°):	±5.5	±3.8	±2.0	±7.7	±5.6	±4.9
Vertical Beamwidth Tolerance(°):	±0.9	±0.6	±0.4	±0.9	±0.5	±0.4
Upper Side Lobe Suppression, Peak to 20°(dB):	14.0	15.8	14.0	14.0	15.5	14.0
Front to back Total Power at 180° ± 30°(dB)	25.7	27.1	26.1	25.7	27.0	28.0
CPR at Boresight(dB):	17.7	16.9	16.7	16.6	17.7	17.5
CPR at Sector(dB):	8.8	5.0	3.5	6.1	5.5	7.2

Mechanical Data

Antenna Dimensions (mm):	1380×396×190
Packing Dimensions (mm):	1650×485×285
Antenna Net Weight/Bracket (kg):	22/5.9
Antenna Gross Weight (kg):	32
Radome Material:	Fiberglass
Pipe OD (mm):	50-115
Mounting Kits (Included):	BA.K.04.00069141, Adjustable Downtilt 0°-18°

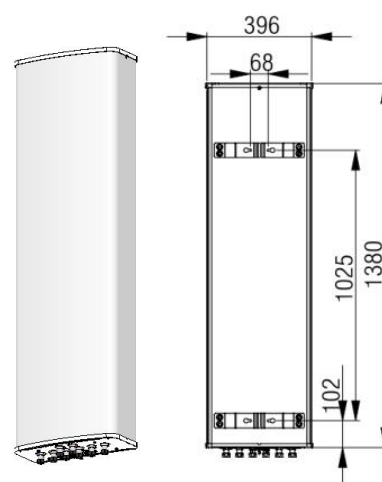

Environmental Ratings

Humidity:	95%RH@+30°C
Temperature (°C):	-40~+70
Wind Load @150 km/h (N):	Frontal/Lateral/: 607/172/798
Max. Wind velocity(km/h):	200

Internal RET Specifications

RET type:	Replaceable RET
RET protocol:	AISG2.0 /3GPP
Input voltage range(V):	10-30 DC
Power consumption(W):	< 5 (motor activated, single RET) < 1 (stand by, single RET), < 1.5 (stand by, 12V)
Adjustment time (full range): (s):	< 120 (typically, depending on antenna type)
RET connector:	1 pair of AISG 5 pin male & female
Pin assignment according AISG:	8-pin circular connector conforming to IEC 60130-9 - Ed. 3.0
Lightning protection (kA):	5 (8/20 μs Differential mode), 8 (8/20 μs Common mode)

Typical Patterns

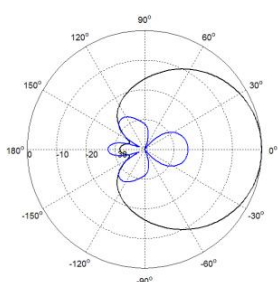

Azimuth(Low band)

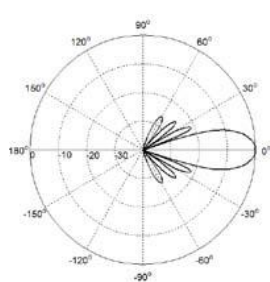

Elevation(Low band)

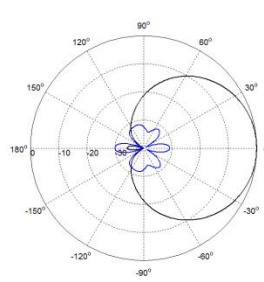

Azimuth(High band)

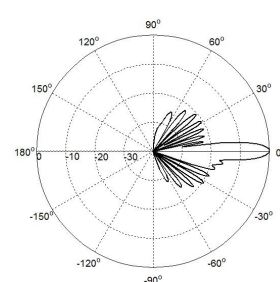

Elevation(High band)

ULLLPX305.10P-C

Bottom View

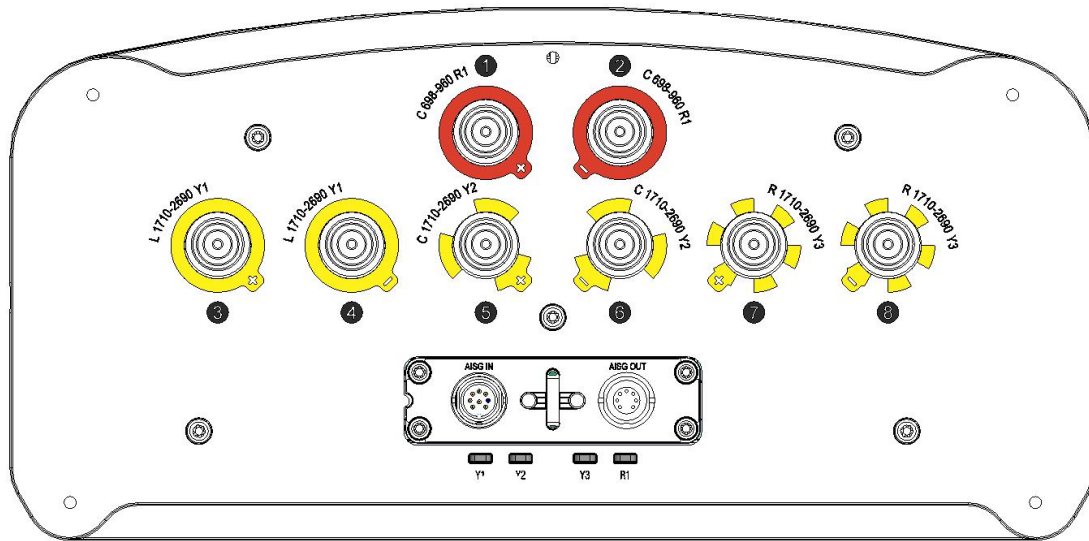

Correlation Table

Frequency range	Array	Connector	RET S/N
698-960 MHz	R1	1-2	BRxxx.....1R1
1710-2690 MHz	Y1	3-4	BRxxx.....2Y1
1710-2690 MHz	Y2	5-6	BRxxx.....3Y2
1710-2690 MHz	Y3	7-8	BRxxx.....4Y3

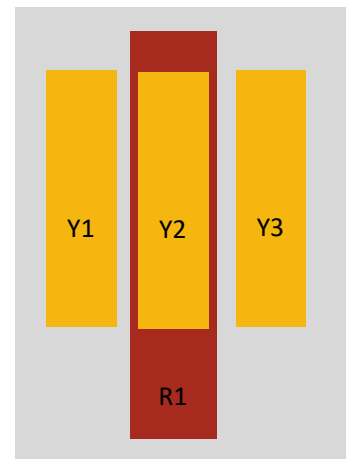

Product Data Sheet

ULLLPX307.10P-C

XXXX Pol Panel Antenna 698-960/3x1710-2690MHz 65°/65° 16/17.5dBi 0°-10°/0°-10° Replaceable RET

Electrical Specifications

Frequency Range (MHz):	698-960(R1)			1710-2690(Y1,Y3)			1710-2690(Y2)		
	698-806	806-880	880-960	1710 -2170	2300 -2490	2490 -2690	1710 -2170	2300 -2490	2490 -2690
Gain (dBi):	14.4 ±0.5	15.2 ±0.5	15.1 ±0.5	16.6 ±0.5	17.1 ±0.5	17.7 ±0.5	15.9 ±0.5	16.0 ±0.5	16.3 ±0.5
Return Loss (dB):	>14 (VSWR<1.5)								
Polarization:	±45°								
Horizontal 3dB Beamwidth (°):	69	65	60	69	65	58	69	65	58
Vertical 3dB Beamwidth (°):	11.0	9.5	8.5	7.5	6.5	5.2	7.0	5.7	5.3
Electrical Downtilt (°):	0-10 Independently Continuously Adjustable			0-10 Independently Continuously Adjustable					
RET Type:	Cascade SRET, AISG 2.0, Upgradeable								
1 st Upper Sidelobe Suppression(dB):	15	16	15	15	16	15	15	16	14
Intraband Isolation (dB):	>26								
Interband Isolation (dB):	>28								
Max. Power Per Port (W):	250			200					
Intermodulation IM3 (dBc):	<-150 (2x43 dBm)								
Impedance (ohm):	50								
Lightning Protection:	DC Grounded								
Connector Type:	8x4.3-10 Female								

BASTA Electrical Specifications

Frequency Range(MHz):	698-960(R1)		
	698-806	806-880	880-960
Average Gain by Beam Tilts (dBi):	14.2	15.0	14.9
Gain by all Beam Tilts Tolerance(dB):	±0.6	±0.5	±0.7
Average Gain by Beam Tilts (dBi):	0° 14.4 5° 14.2 10° 13.9	0° 15.1 5° 15.2 10° 14.6	0° 15.0 5° 15.1 10° 14.4
Horizontal BeamwidthTolerance(°):	±3.1	±1.3	±2.4
Vertical Beamwidth Tolerance(°):	±1.2	±0.5	±0.7
Upper Side Lobe Suppression, Peak to 20°(dB):	14.2	15.3	14.4
Front to back Total Power at 180° ± 30°(dB)	24.7	28.0	28.9
CPR at Boresight(dB):	16.4	17.1	17.4

Product Data Sheet

ULLLPX307.10P-C

BASTA Electrical Specifications

Frequency Range(MHz):	1710-2690(Y1,Y3)			1710-2690(Y2)		
	1710-2170	2300-2490	2490-2690	1710-2170	2300-2490	2490-2690
Average Gain by Beam Tilts (dBi):	16.4	16.9	17.4	15.8	15.7	15.8
Gain by all Beam Tilts Tolerance(dB):	±0.5	±0.5	±0.5	±0.8	±0.7	±0.8
Average Gain by Beam Tilts (dBi):	0° 16.3	0° 16.6	0° 17.4	0° 15.8	0° 16.0	0° 16.3
	5° 16.6	5° 17.1	5° 17.7	5° 15.9	5° 15.9	5° 16.1
	10° 16.3	10° 16.8	10° 17.3	10° 15.7	10° 15.8	10° 16.0
Horizontal BeamwidthTolerance(°):	±2.9	±3.8	±2.5	±5.2	±3.8	±4.5
Vertical Beamwidth Tolerance(°):	±1.0	±0.7	±0.6	±0.9	±0.6	±0.6
Upper Side Lobe Suppression, Peak to 20°(dB):	14.3	15.1	14.4	14.4	15.7	13.7
Front to back Total Power at 180° ± 30°(dB)	26.6	27.5	27.7	26.5	27.4	27.5
CPR at Boresight(dB):	17.5	16.7	17.2	16.6	17.7	17.5

Mechanical Data

Antenna Dimensions (mm):	1820×396×190
Packing Dimensions (mm):	2090×485×285
Antenna Net Weight/Bracket (kg):	27.5/5.9
Antenna Gross Weight (kg):	38.5
Radome Material:	Fiberglass
Pipe OD (mm):	50-115
Mounting Kits (Included):	BA.K.04.00069101, Adjustable Downtilt 0°-12°

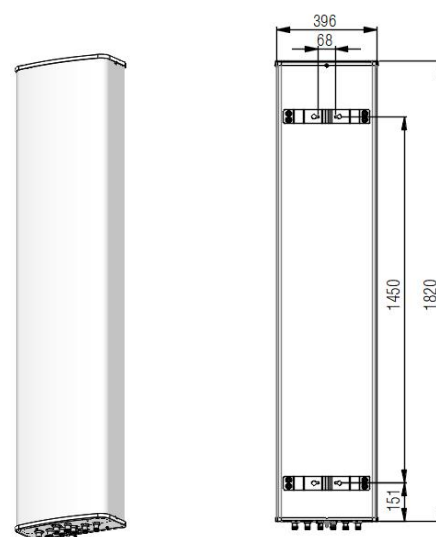

Environmental Ratings

Humidity:	95%RH@+30°C
Temperature (°C):	-40~+70
Wind Load @150 km/h (N):	Frontal/Lateral/: 810/230/1065
Max.Wind velocity(km/h):	200

Internal RET Specifications

RET type:	Replaceable RET
RET protocol:	AISG2.0 /3GPP
Input voltage range(V):	10-30 DC
Power consumption(W):	< 5 (motor activated, single RET) < 1 (stand by, single RET), < 1.5 stand by, 12V)
Adjustment time (full range): (s):	< 120 (typically, depending on antenna type)
RET connector:	1 pair of AISG 5 pin male & female
Pin assignment according AISG:	8-pin circular connector conforming to IEC 60130-9 - Ed. 3.0
Lightning protection (kA):	5 (8/20 μs Differential mode), 8 (8/20 μs Common mode)

Typical Patterns

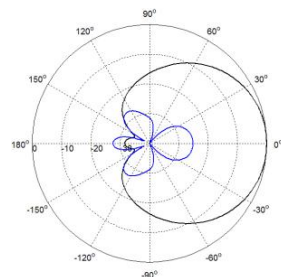

Azimuth(Low band)

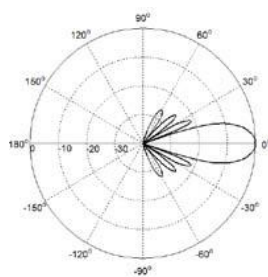

Elevation(Low band)

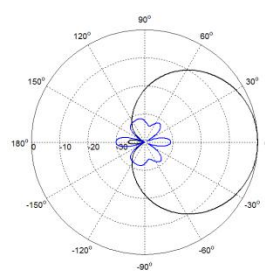

Azimuth(High band)

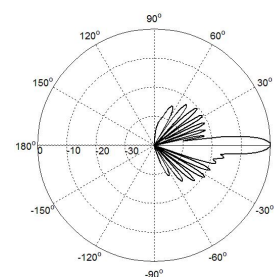

Elevation(High band)

ULLLPX307.10P-C

Bottom View

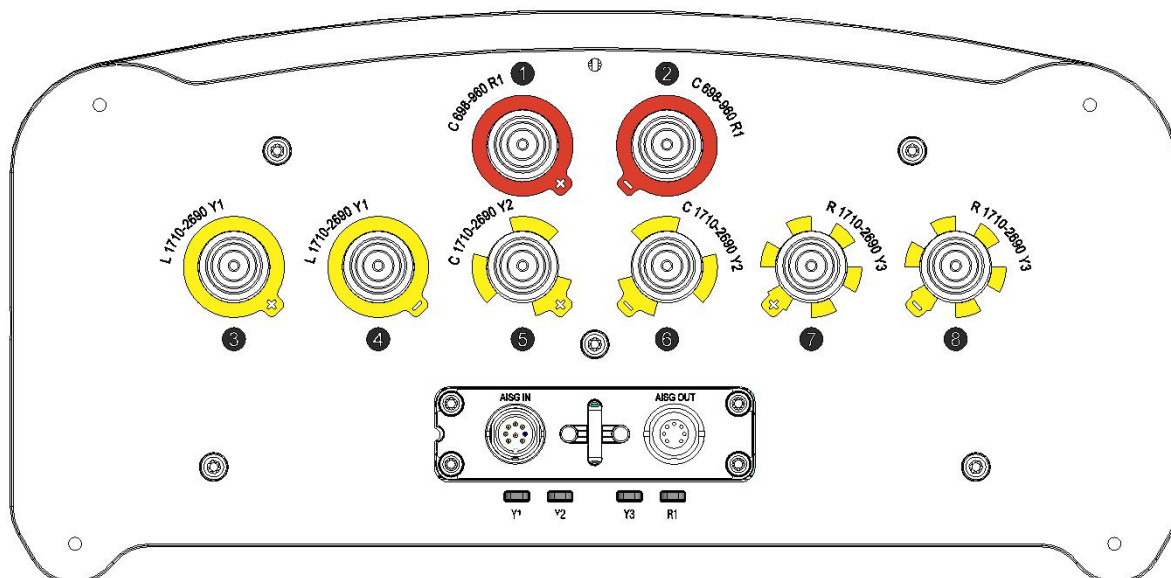

Correlation Table

Frequency range	Array	Connector	RET S/N
698-960 MHz	R1	1-2	BRxxx.....1R1
1710-2690 MHz	Y1	3-4	BRxxx.....2Y1
1710-2690 MHz	Y2	5-6	BRxxx.....3Y2
1710-2690 MHz	Y3	7-8	BRxxx.....4Y3

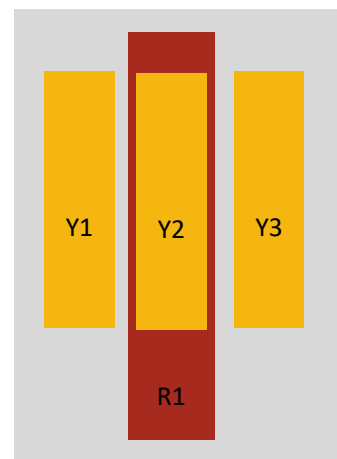

Product Data Sheet

ULLLPX307.12P-C

XXXX Pol Panel Antenna 698-960/3×1710-2690MHz 65°/65 16/18dBi 0°-10° Replaceable RET

Electrical Specifications

Frequency Range (MHz):	698-960(R1)			1710-2690(Y1,Y2,Y3)		
	698-806	806-880	880-960	1710-2170	2300-2490	2490-2690
Gain (dBi):	14.6±0.5	15.3±0.5	15.6±0.5	16.8±0.5	17.5±0.5	17.8±0.5
Return Loss (dB):	>14 (VSWR<1.5)					
Polarization:	±45°					
Horizontal 3dB Beamwidth (°):	65	62	60	67	60	58
Vertical 3dB Beamwidth (°):	11.0	10.0	9.3	6.0	4.8	4.3
Electrical Downtilt (°):	0-10 Independently Continuously Adjustable					
RET Type:	Cascade SRET, AISG 2.0, Upgradeable					
1 st Upper Sidelobe Suppression (dB):	15	15	15	15	15	15
Front to Back Ratio 180±30°(dB):	22	23	24	25	25	25
Cross Polar Ratio 0° (dB):	15	15	15	15	15	15
Intraband Isolation (dB):	>25			>25		
Interband Isolation (dB):	>28					
Max. Power Per Port (W):	250			200		
Intermodulation IM3 (dBc):	<-150 (2×43dBm)					
Impedance (ohm):	50					
Lightning Protection:	DC Grounded					
Connector Type:	8×4.3-10 Female					

BASTA Electrical Specification

Frequency Range(MHz):	698-960(R1)			1710-2690(Y1,Y3)			1710-2690(Y2)		
	698 -806	806 -880	880 -960	1710 -2170	2300 -2490	2490 -2690	1710 -2170	2300 -2490	2490 -2690
Average Gain by all Beam Tilts (dBi):	14.4	15.2	15.4	16.8	17.2	17.4	16.7	17.1	17.3
Gain by all Beam Tilts Tolerance(dB):	±0.5	±0.6	±0.6	±0.7	±0.7	±0.6	±0.5	±0.5	±0.4
Average Gain by Beam Tilt (dBi):	14.6	15.3	15.5	16.9	17.3	17.5	16.8	17.2	17.2
	14.4	15.3	15.6	17.0	17.4	17.6	16.8	17.3	17.6
	14.2	15.0	15.2	16.5	16.8	17.0	16.6	16.8	17.0
Horizontal Beamwidth Tolerance(°):	±1.5	±1.8	±1.4	±5.0	±4.2	±4.9	±2.8	±6.7	±5.1
Vertical Beamwidth Tolerance(°):	±1.2	±0.9	±1.0	±0.7	±0.4	±0.4	±0.4	±0.3	±0.4
USLS to 20° above beampeak(dB):	14.3	14.8	15.0	15.3	16.2	16.0	15.4	17.1	16.7
Front to back Ratio at 180° ± 30°(dB)	21.5	23.7	25.2	24.7	24.9	25.1	26.8	28.1	28.0
CPR at Boresight(dB):	28.4	23.4	26.3	15.3	16.0	16.3	17.2	20.8	19.3



Product Data Sheet

ULLLPX307.12P-C

Mechanical Data

Antenna Dimensions (mm):	1995×396×190
Packing Dimensions (mm):	2265×485×285
Antenna Net Weight/Bracket (kg):	28/5.9
Antenna Gross Weight (kg):	40
Radome Material:	Fiberglass
Pipe OD (mm):	50-115
Mounting Kits (Included):	BA.K.04.00069121, Adjustable Downtilt 0°-14°

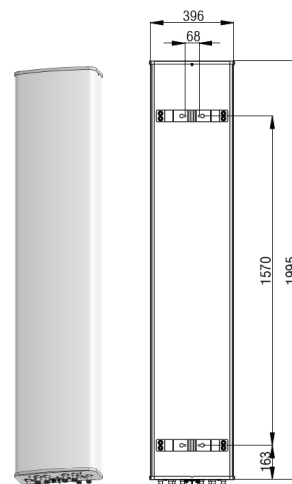

Environmental Ratings

Humidity:	95%RH@+30°C
Temperature (°C):	-40~+70
Wind Load @150 km/h (N):	Frontal/Lateral/Rearside: 891/252/1172
Max. Wind velocity(km/h):	200

Internal RET Specifications

RET type:	Replaceable RET
RET protocol:	AISG2.0 /3GPP
Input voltage range(V):	10-30 DC
Power consumption(W):	< 5 (motor activated, single RET) < 1 (stand by, single RET), < 1.5 (stand by, 12V)
Adjustment time (full range) (s):	< 120 (typically, depending on antenna type)
RET connector:	1 pair of AISG 5 pin male & female
Pin assignment according AISG:	8 pin circular connector conforming to IEC 60130-9 - Ed. 3.0
Lightning protection (kA):	5 (8/20 μs Differential mode), 8 (8/20 μs Common mode)

Typical Patterns

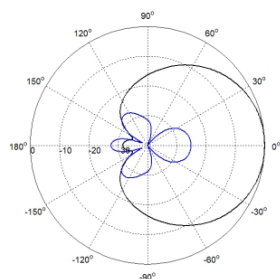

Azimuth(Low band)

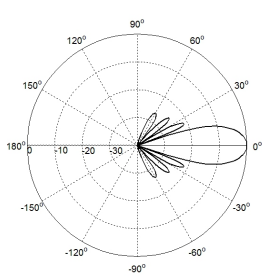

Elevation(Low band)

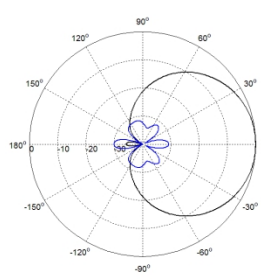

Azimuth(High band)

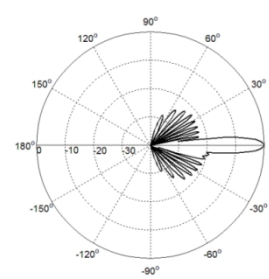

Elevation(High band)



ULLLPX307.12P-C

Bottom View

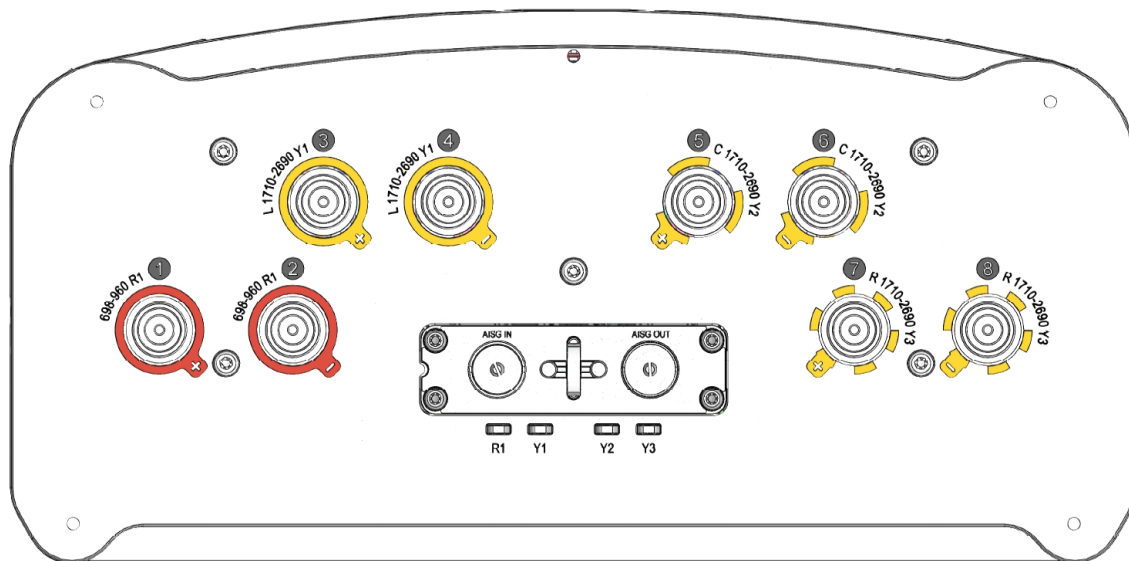

Correlation Table

Frequency range	Array	Connector	RET S/N
698-960MHz	R1	1-2	BRxxx.....1R1
1710-2690MHz	Y1	3-4	BRxxx.....2Y1
1710-2690MHz	Y2	5-6	BRxxx.....3Y2
1710-2690MHz	Y3	7-8	BRxxx.....4Y3

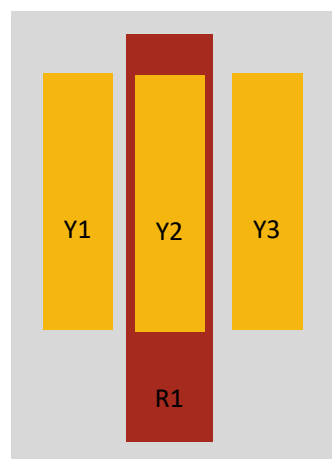

Product Data Sheet

ULLLPX309.12P-C

XXXX Pol Panel Antenna 698-960/3×1710-2690MHz 65°/65° 16.5/18dBi 2°-12°/0°-10° Replaceable RET

Electrical Specifications

Frequency Range (MHz):	698-960(R1)			1710-2690(Y1,Y2,Y3)		
	698-806	806-880	880-960	1710-2170	2300-2490	2490-2690
Gain (dBi):	15.5±0.5	16.0±0.5	16.5±0.5	16.8±0.5	17.5±0.5	17.8±0.5
Return Loss (dB):	>14 (VSWR<1.5)					
Polarization:	±45°					
Horizontal 3dB Beamwidth (°):	65	62	60	67	60	58
Vertical 3dB Beamwidth (°):	9.5	8.5	7.5	6.0	4.8	4.3
Electrical Downtilt (°):	2-12 Independently Continuously Adjustable			0-10 Independently Continuously Adjustable		
RET Type:	Cascade SRET, AISG 2.0, Upgradeable					
1 st Upper Sidelobe Suppression (dB):	15	15	15	15	15	15
Front to Back Ratio 180±30°(dB):	22	24	24	25	25	25
Cross Polar Ratio 0° (dB):	15	15	15	15	15	15
Intraband Isolation (dB):	>25			>25		
Interband Isolation (dB):	>28					
Max. Power Per Port (W):	250			200		
Intermodulation IM3 (dBc):	<-150 (2×43dBm)					
Impedance (ohm):	50					
Lightning Protection:	DC Grounded					
Connector Type:	8×4.3-10 Female					

BASTA Electrical Specification

Frequency Range(MHz):	698-960(R1)			1710-2690(Y1,Y3)			1710-2690(Y2)		
	698-806	806-880	880-960	1710-2170	2300-2490	2490-2690	1710-2170	2300-2490	2490-2690
Average Gain by all Beam Tilts (dBi):	15.4	16.2	16.5	16.8	17.2	17.3	16.9	17.2	17.2
Gain by all Beam Tilts Tolerance(dB):	±0.7	±0.3	±0.5	±0.6	±0.5	±0.5	±0.6	±0.5	±0.6
Average Gain by Beam Tilt (dBi):	15.5	16.3	16.7	16.7	17.2	17.3	17.1	17.3	17.0
	15.4	16.3	16.7	17.1	17.4	17.6	17.1	17.4	17.5
	15.3	16.0	16.2	16.6	16.9	17.0	16.6	16.8	17.1
Horizontal Beamwidth Tolerance(°):	±2.9	±1.5	±1.9	±5.0	±4.2	±4.9	±4.0	±5.6	±4.2
Vertical Beamwidth Tolerance(°):	±0.8	±0.3	±0.7	±0.7	±0.3	±0.3	±0.7	±0.3	±0.3
USLS to 20° above beampeak(dB):	14.5	13.7	15.0	15.5	16.2	16.3	15.2	17.5	17.4
Front to back Ratio at 180° ± 30°(dB)	21.2	24.1	25.0	24.5	25.6	25.0	25.8	29.1	28.0
CPR at Boresight(dB):	19.2	26.2	24.1	15.6	15.8	16.0	17.2	20.8	19.3



Product Data Sheet

ULLLPX309.12P-C

Mechanical Data

Antenna Dimensions (mm):	2495×396×190
Packing Dimensions (mm):	2765×485×285
Antenna Net Weight/Bracket (kg):	34 / 5.9
Antenna Gross Weight (kg):	47
Radome Material:	Fiberglass
Pipe OD (mm):	50-115
Mounting Kits (Included):	BA.K.04.00069091, Adjustable Downtilt 0°-10°

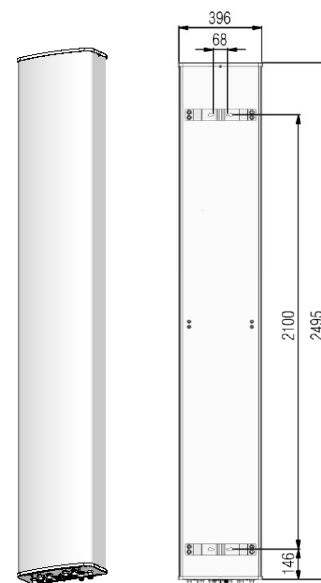

Environmental Ratings

Humidity:	95%RH@+30°C
Temperature (°C):	-40~+70
Wind Load @150 km/h (N):	Frontal/Lateral/Rearside: 1125/327/1480
Max. Wind velocity(km/h):	200

Internal RET Specifications

RET type:	Replaceable RET
RET protocol:	AISG2.0 /3GPP
Input voltage range(V):	10-30 DC
Power consumption(W):	< 5 (motor activated, single RET) < 1 (stand by, single RET), < 1.5 (stand by, 12V)
Adjustment time (full range) (s):	< 120 (typically, depending on antenna type)
RET connector:	1 pair of AISG 5 pin male & female
Pin assignment according AISG:	8 pin circular connector conforming to IEC 60130-9 - Ed. 3.0
Lightning protection (kA):	5 (8/20 μs Differential mode), 8 (8/20 μs Common mode)

Typical Patterns

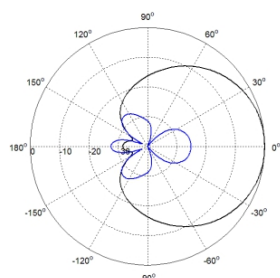

Azimuth(Low band)

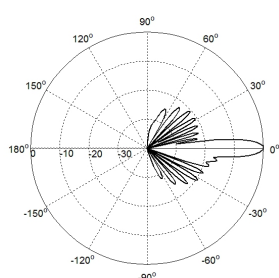

Elevation(Low band)

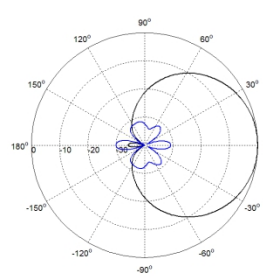

Azimuth(High band)

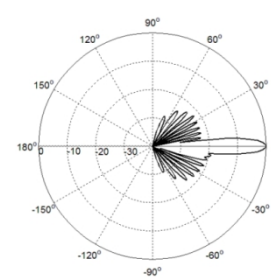

Elevation(High band)



ULLLPX309.12P-C

Bottom View

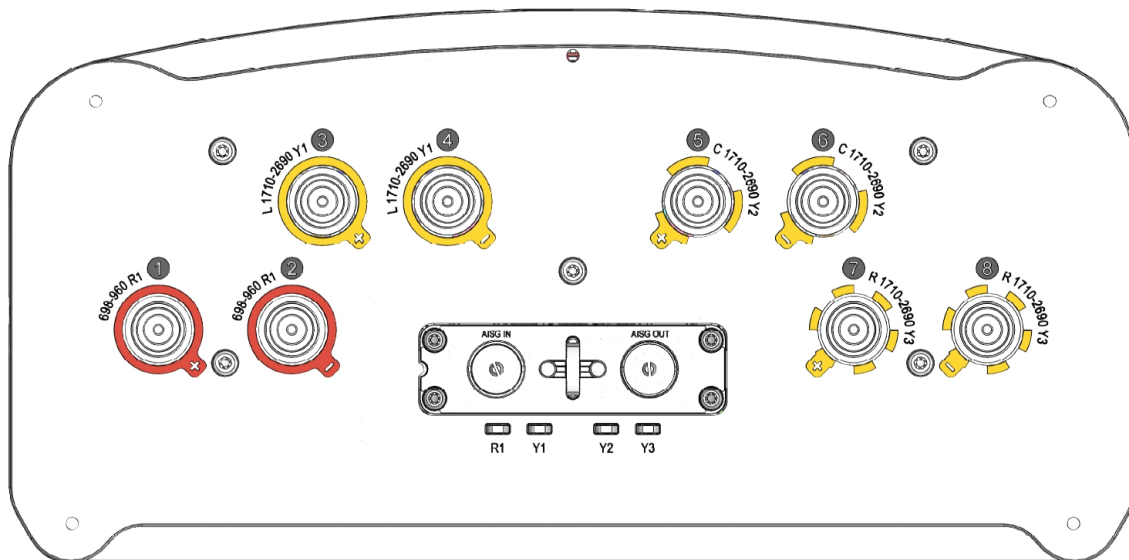

Correlation Table

Frequency range	Array	Connector	RET S/N
698-960MHz	R1	1-2	BRxxx.....1R1
1710-2690MHz	Y1	3-4	BRxxx.....2Y1
1710-2690MHz	Y2	5-6	BRxxx.....3Y2
1710-2690MHz	Y3	7-8	BRxxx.....4Y3

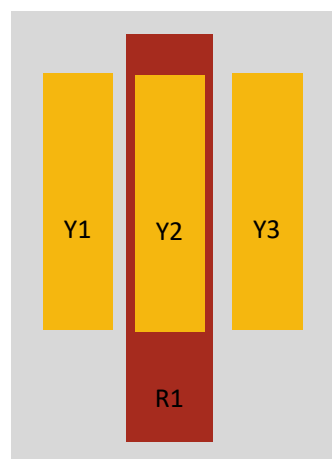

Product Data Sheet

UL3PX306.7P-C

XXXX Pol Panel Antenna 694-960/2x1710-2690/1710-2690MHz 65°/65°/65° 15/16/15.5dBi
0°-10°/0°-10°/0°-10° Replaceable RET

Electrical Specifications

Frequency Range (MHz):	694-960(R1)			1710-2690(Y1,Y3)			1710-2690(Y2)		
	694-806	806-880	880-960	1710-2170	2300-2490	2490-2690	1710-2170	2300-2490	2490-2690
Gain (dBi):	14.0 ±0.5	14.8 ±0.5	15.0 ±0.5	15.3 ±0.5	15.7 ±0.5	16.0 ±0.5	15.0 ±0.5	15.3 ±0.5	15.6 ±0.5
Return Loss (dB):	>14 (VSWR<1.5)								
Polarization:	±45°								
Horizontal 3dB Beamwidth (°):	69	65	62	68	62	57	68	62	57
Vertical 3dB Beamwidth (°):	14	12.5	11.0	11.0	9.0	8.0	11.0	9.0	8.0
Electrical Downtilt (°):	0-10 Independently Continuously Adjustable			0-10 Independently Continuously Adjustable					
RET Type:	Cascade SRET, AISG 2.0, Upgradeable								
1 st Upper Sidelobe Suppression (dB):	15	15	15	15	15	15	15	15	15
Front to Back Ratio (dB):	22	24	24	25	25	25	25	25	25
Cross Polar Ratio 0°(dB):	15	15	15	15	15	15	15	15	15
Intraband Isolation (dB):	>26			>26			>26		
Interband Isolation (dB):	>28								
Max. Power Per Port (W):	250			200					
Intermodulation IM3 (dBc):	<-150(2x43dBm)								
Impedance (ohm):	50								
Lightning Protection:	DC Grounded								
Connector Type:	8x4.3-10 Female								

BASTA Electrical Specification

Frequency Range(MHz):	694-960(R1)			1710-2690(Y1,Y3)		
	694-806	806-880	880-960	1710-2170	2300-2490	2490-2690
Average Gain by all Beam Tilts (dBi):	14.1	14.6	14.8	14.8	15.4	15.8
Gain by all Beam Tilts Tolerance(dB):	±0.7	±0.5	±0.4	±0.3	±0.7	±0.6
Average Gain by Beam Tilt (dBi):	0° 14.3	0° 14.6	0° 14.9	0° 15.1	0° 15.6	0° 16.1
	5° 14.2	5° 14.8	5° 15.1	5° 14.8	5° 15.4	5° 15.9
	10° 13.8	10° 14.3	10° 14.5	10° 14.5	10° 15.1	10° 15.5
Horizontal Beamwidth Tolerance(°):	±3.5	±2.8	±2.5	±4.0	±3.6	±4.3
Vertical Beamwidth Tolerance(°):	±1.2	±0.8	±0.6	±1.2	±0.8	±0.6
USLS to 20° above beampeak(dB):	16.6	16.4	15.1	17.1	15.6	15.2
Front to back Ratio at 180° ± 30°(dB)	23.2	25.5	24.1	25.9	25.9	26.3
CPR at Boresight(dB):	17.4	17.7	16.8	18.8	16.2	19.2

BASTA Electrical Specification

Frequency Range(MHz):	1710-2690(Y2)		
	1710-2170	2300-2490	2490-2690
Average Gain by all Beam Tilts (dBi):	14.6	15.0	15.3
Gain by all Beam Tilts Tolerance(dB):	±0.4	±0.5	±0.5
Average Gain by Beam Tilt (dBi):	0° 14.8	0° 15.2	0° 15.5
	5° 14.7	5° 15.0	5° 15.3
	10° 14.3	10° 14.7	10° 15.0
Horizontal BeamwidthTolerance(°):	±4.9	±4.1	±4.0

Product Data Sheet

UL3PX306.7P-C

Vertical Beamwidth Tolerance(°):	±1.3	±0.8	±0.5
USLS to 20° above beampeak(dB):	15.6	15.8	15.7
Front to back Ratio at 180° ± 30°(dB)	25.9	27.2	26.5
CPR at Boresight(dB):	17.2	17.3	17.1

Mechanical Data

Antenna Dimensions(mm):	1650×339×169
Packing Dimensions (mm):	1940×425×260
Antenna Net Weight/Bracket(kg):	21/5.9
Antenna Gross Weight(kg):	31
Radome Material:	Fiberglass
Pipe OD (mm):	50-114
Mounting Kits (Included):	BA.K.04.00069141, Adjustable Downtilt 0°-18°

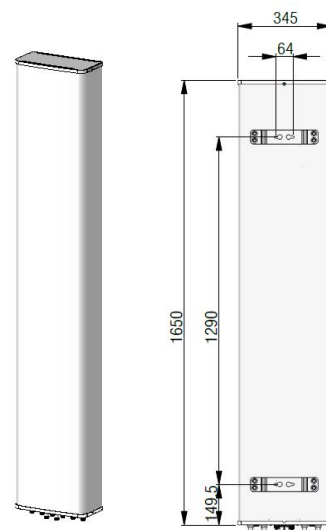

Environmental Ratings

Humidity:	95%RH@+30°C
Temperature (°C):	-40~+70
Wind Load @150 km/h (N):	Frontal/Lateral/Rearside:978/288/1142
Max. Wind velocity(km/h):	200

Internal RET Specifications

RET type:	Replaceable RET
RET protocol:	AISG2.0 /3GPP
Input voltage range(V):	10-30 DC
Power consumption(W):	< 5 (motor activated, single RET) < 1 (stand by, single RET), < 1.5 (stand by, 12V)
Adjustment time (full range) (s):	< 120 (typically, depending on antenna type)
RET connector:	1 pair of AISG 5 pin male & female
Pin assignment according AISG:	8pin circular connector conforming to IEC 60130-9 - Ed. 3.0
Lightning protection (kA):	5 (8/20 μs Differential mode), 8 (8/20 μs Common mode)

Typical Patterns

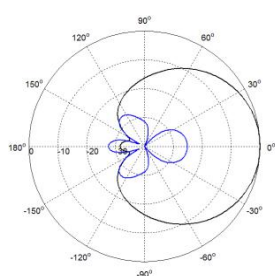

Azimuth(Low Band)

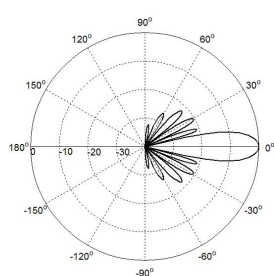

Elevation(Low Band)

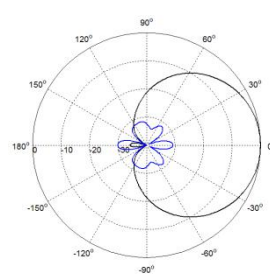

Azimuth(High Band)

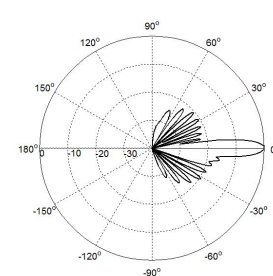

Elevation(High Band)

UL3PX306.7P-C

Bottom View

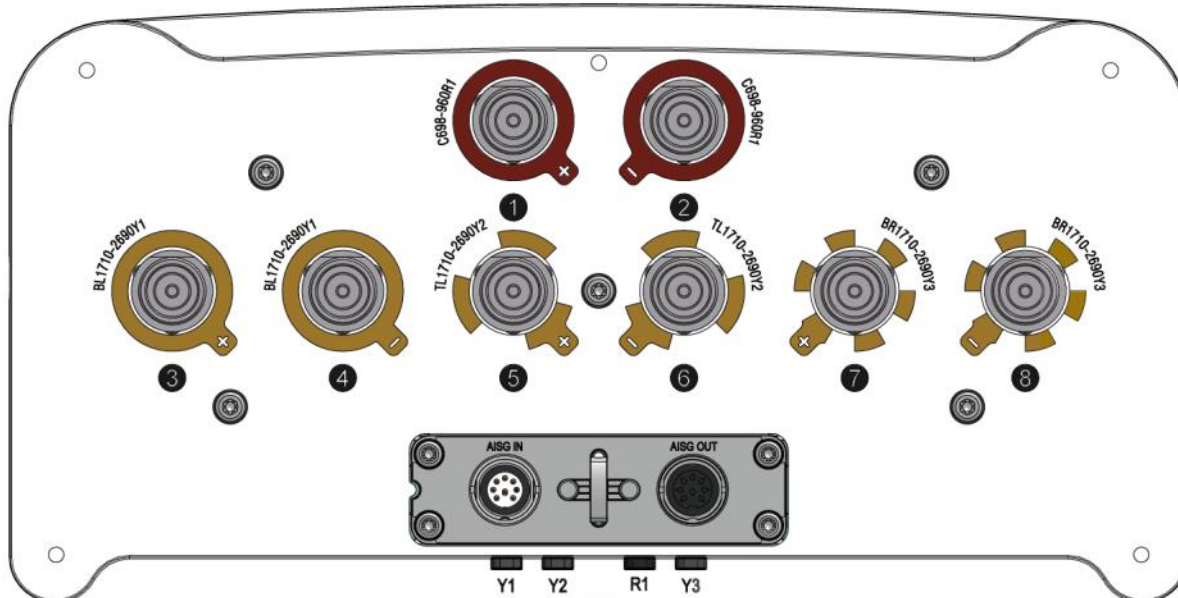

Correlation Table

Frequency range	Array	Connector	RET S/N
694-960 MHz	R1	1-2	BRxxx.....1R1
1710-2690 MHz	Y1	3-4	BRxxx.....2Y1
1710-2690 MHz	Y2	5-6	BRxxx.....3Y2
1710-2690 MHz	Y3	7-8	BRxxx.....4Y3

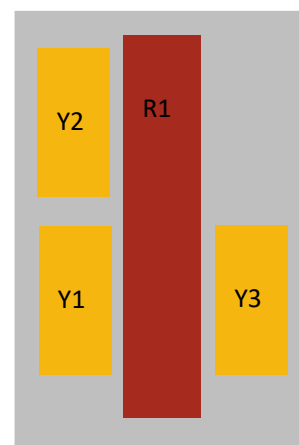

Product Data Sheet

UL3PX307.8P-C-V1

XXXX Pol Panel Antenna 694-960/2×1710-2690/1710-2690MHz 65°/65°/65° 16/16.5/16dBi
0°-10°/0°-10°/0°-10° Replaceable RET

Electrical Specifications

Frequency Range (MHz):	694-960(R1)			1710-2690(Y1,Y3)			1710-2690(Y2)		
	694-806	806-880	880-960	1710-2170	2300-2490	2490-2690	1710-2170	2300-2490	2490-2690
Gain (dBi):	14.7 ±0.5	15.4 ±0.5	15.7 ±0.5	15.5 ±0.5	16.3 ±0.5	16.5 ±0.5	15.1 ±0.5	15.8 ±0.5	16.0 ±0.5
Return Loss (dB):	>14 (VSWR<1.5)								
Polarization:	±45°								
Horizontal 3dB Beamwidth (°):	69	65	62	68	62	57	68	62	57
Vertical 3dB Beamwidth (°):	13	11.5	10.2	9	8	7	9	8	7
Electrical Downtilt (°):	0-10 Independently Continuously Adjustable			0-10 Independently Continuously Adjustable					
RET Type:	Cascade SRET, AISG 2.0, Upgradeable								
1 st Upper Sidelobe Suppression (dB):	15	15	15	15	15	15	15	15	15
Front to Back Ratio (dB):	22	24	24	25	25	25	25	25	25
Cross Polar Ratio 0°(dB):	15	15	15	15	15	15	15	15	15
Intraband Isolation (dB):	Tilt 0°-2°: >26 Tilt 3°-10°: >28			>28			>28		
Interband Isolation (dB):	>28								
Max. Power Per Port (W):	250			200					
Intermodulation IM3 (dBc):	<-150(2×43dBm)								
Impedance (ohm):	50								
Lightning Protection:	DC Grounded								

BASTA Electrical Specification

Frequency Range(MHz):	694-960(R1)			1710-2690(Y1,Y3)		
	694-806	806-880	880-960	1710-2170	2300-2490	2490-2690
Average Gain by all Beam Tilts (dBi):	15.0	15.3	15.6	15.5	16.0	16.4
Gain by all Beam Tilts Tolerance(dB):	±0.7	±0.6	±0.5	±0.8	±0.5	±0.4
Average Gain by Beam Tilt (dBi):	0° 14.9	0° 15.2	0° 15.5	0° 15.4	0° 16.0	0° 16.3
	5° 15.2	5° 15.5	5° 15.8	5° 15.7	5° 16.3	5° 16.7
	10° 14.7	10° 14.9	10° 15.2	10° 15.2	10° 15.8	10° 16.0
Horizontal Beamwidth Tolerance(°):	±3.3	±2.1	±2.6	±6.9	±5.3	±5.0
Vertical Beamwidth Tolerance(°):	±0.8	±0.5	±0.3	±1.4	±0.8	±0.6
USLS to 20° above beampeak(dB):	15.6	15.4	15.1	15.5	15.3	16.2
Front to back Ratio at 180° ± 30°(dB)	26.6	27.5	27.1	26.8	27.3	30.3
CPR at Boresight(dB):	17.4	18.7	18.6	19.4	18.8	21.6

BASTA Electrical Specification

Frequency Range(MHz):	1710-2690(Y2)		
	1710-2170	2300-2490	2490-2690
Average Gain by all Beam Tilts (dBi):	15.2	15.7	16.1
Gain by all Beam Tilts Tolerance(dB):	±0.7	±0.6	±0.4
Average Gain by Beam Tilt (dBi):	0° 15.0	0° 15.7	0° 16.1
	5° 15.4	5° 16.0	5° 16.3
	10° 14.8	10° 15.5	10° 15.7
Horizontal Beamwidth Tolerance(°):	±6.5	±4.3	±3.6

Product Data Sheet

UL3PX307.8P-C-V1

Vertical Beamwidth Tolerance(°):	±1.5	±0.6	±0.6
USLS to 20° above beampeak(dB):	16.2	15.4	16.0
Front to back Ratio at 180° ± 30°(dB)	26.9	27.7	28.9
CPR at Boresight(dB):	17.2	18.3	18.1

Mechanical Data

Antenna Dimensions(mm):	1960×339×169
Packing Dimensions (mm):	2300×425×260
Antenna Net Weight/Bracket(kg):	27/5.7
Antenna Gross Weight(kg):	36
Radome Material:	Fiberglass
Pipe OD (mm):	70-114
Mounting Kits (Included):	BA.K.04.00069101, Adjustable Downtilt 0°-12°
Connector Type:	8×4.3-10 Female

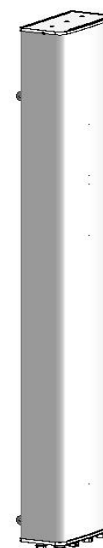

Environmental Ratings

Humidity:	95%RH@+30°C
Temperature (°C):	-40~+70
Wind Load @150 km/h (N):	Frontal/ Lateral/ Rearside: 1206/358/1408
Max.Wind velocity(km/h):	200

Internal RET Specifications

RET type:	Replaceable RET
RET protocol:	AISG2.0 /3GPP
Input voltage range(V):	10-30 DC
Power consumption(W):	< 5 (motor activated , single RET) < 1 (stand by, single RET), < 1.5 (stand by, 12V)
Adjustment time (full range) (s):	< 120 (typically, depending on antenna type)
RET connector:	pair of AISG 5 pin male & female
Pin assignment according AISG:	8pin circular connector conforming to IEC 60130-9 - Ed. 3.0
Lightning protection (kA):	5 (8/20 μs Differential mode), 8 (8/20 μs Common mode)

Typical Patterns

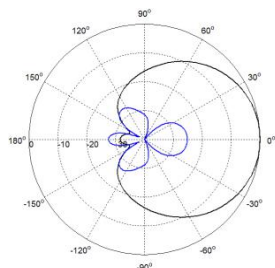

Azimuth(Low Band)

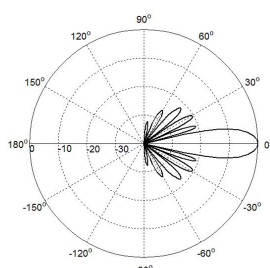

Elevation(Low Band)

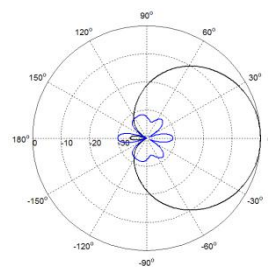

Azimuth(High Band)

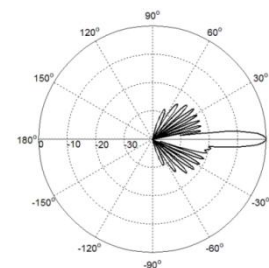

Elevation(High Band)

UL3PX307.8P-C-V1

Bottom View

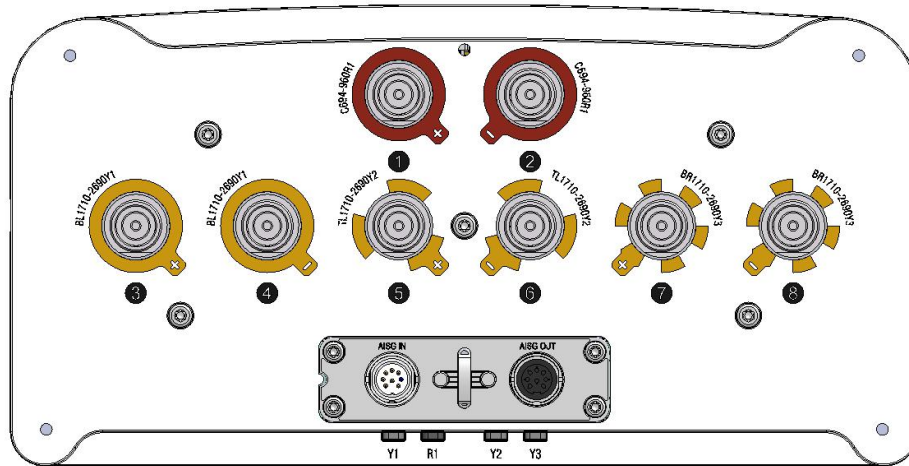

Correlation Table

Frequency range	Array	Connector	RET S/N
790-960 MHz	R1	1-2	BRxxx.....1R1
1710-2690 MHz	Y1	3-4	BRxxx.....1Y1
1710-2690 MHz	Y2	5-6	BRxxx.....1Y2
1710-2690 MHz	Y3	7-8	BRxxx.....1Y3

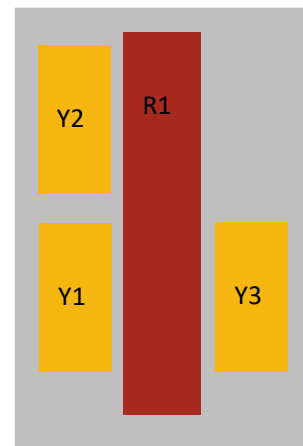

Product Data Sheet

UL3PX309.10P-C

XXXX Pol Panel Antenna 698-960/2×1710-2690/1710-2690MHz 65°/65°/65° 17/17.5/17dBi
0°-10°/0°-10°/0°-10° Replaceable RET

Electrical Specifications

Frequency Range (MHz):	698-960(R1)			1710-2690(Y1,Y3)			1710-2690(Y2)		
	698-806	806-880	880-960	1710-2170	2300-2490	2490-2690	1710-2170	2300-2490	2490-2690
Gain (dBi):	15.7 ±0.5	16.2 ±0.5	16.7 ±0.5	16.0 ±0.5	16.6 ±0.5	17.3 ±0.5	15.5 ±0.5	16.1 ±0.5	16.7 ±0.5
Return Loss (dB):	>14 (VSWR<1.5)								
Polarization:	±45°								
Horizontal 3dB Beamwidth (°):	68	65	62	68	62	57	68	62	57
Vertical 3dB Beamwidth(°):	9.5	8.2	7.2	6.8	5.8	5.3	6.8	5.8	5.3
Electrical Downtilt (°):	0-10 Independently Continuously Adjustable								
1 st Upper Sidelobe Suppression (dB):	15	15	15	16	16	15	16	16	15
Front to Back Ratio (dB):	23	23	23	25	25	25	25	25	25
Cross Polar Ratio 0°(dB):	15	15	15	15	15	15	15	15	15
Intraband Isolation (dB):	>26			>28			>28		
Interband Isolation (dB):	>28								
Average power tolerance (W):	250			200					
Intermodulation IM3 (dBc):	<-150(2×43dBm)								
Impedance (ohm):	50								
Lightning Protection:	DC Grounded								
Connector Type:	8×4.3-10 Female								

BASTA Electrical Specification

Frequency Range(MHz):	698-960(R1)			1710-2690(Y1)			1710-2690(Y2)			1710-2690(Y3)			
	698-806	806-880	880-960	1710-2170	2300-2490	2490-2690	1710-2170	2300-2490	2490-2690	1710-2170	2300-2490	2490-2690	
Average Gain by all Beam Tilts (dBi):	15.5	16.0	16.2	15.8	16.6	17.2	15.3	16.1	16.7	15.7	16.5	17.0	
Gain by all Beam Tilts Tolerance(dB):	±0.6	±0.4	±0.3	±0.6	±0.7	±0.6	±0.7	±0.6	±0.5	±0.6	±0.5	±0.6	
Average Gain by Beam Tilt (dBi):	0°	15.6	16.2	16.4	16.0	16.9	17.4	15.5	16.4	16.9	15.9	16.7	17.1
	5°	15.5	16.0	16.2	15.9	16.6	17.0	15.4	16.1	16.5	15.8	16.5	17.1
	10°	15.4	15.8	16.0	15.7	16.4	16.9	15.2	15.9	16.4	15.6	16.2	16.7
Horizontal Beamwidth Tolerance(°):	±1.4	±3.3	±1.6	±6.7	±3.8	±5.6	±4.2	±5.9	±4.2	±6.5	±5.3	±4.3	
Vertical Beamwidth Tolerance(°):	±0.8	±0.8	±0.5	±0.9	±0.7	±0.5	±1.1	±0.9	±0.4	±0.9	±0.6	±0.4	
USLS to 20° above beampeak(dB):	17.0	15.4	15.6	21.6	22.0	19.1	17.3	21.0	17.6	20.5	22.3	18.7	
Front to back Ratio at 180° ± 30°(dB)	27.0	28.3	29.0	29.7	31.7	31.6	28.5	31.5	30.3	28.6	31.0	31.2	
CPR at Boresight(dB):	23.0	24.0	21.8	24.5	22.1	25.5	24.2	20.5	24.1	22.5	23.5	26.8	

Product Data Sheet

UL3PX309.10P-C

Mechanical Data

Antenna Dimensions (mm):	2495×339×169
Packing Dimensions (mm):	2785×425×260
Antenna Net Weight/bracket (kg):	28.1/5.9
Antenna Gross Weight (kg):	38.3
Radome Material:	Fiberglass
Pipe OD (mm):	70-114
Mounting Kits (Included):	BA.K.04.00069091, Adjustable Downtilt0°-10°

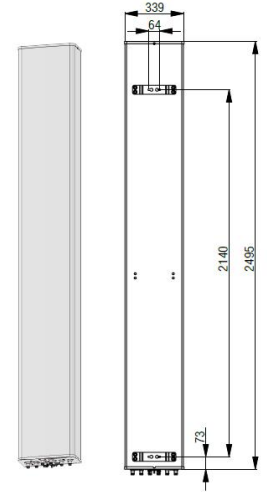

Environmental Ratings

Humidity:	95%RH@+30°C
Temperature (°C):	-40~+70
Wind Load @150 km/h (N):	Frontal/Lateral/Rearside:1568/464/1830
Max. Wind velocity(km/h):	200

Internal RET Specifications

RET Type:	Replaceable RET
RET protocol:	AISG 2.0 /3 GPP
Input voltage range(V):	10-30 DC
Power consumption (W):	< 5 (motor activated, single RET) < 1 (stand by, single RET), < 1.5 (stand by, 12V)
Adjustment time (full range) (s):	< 120 (typically, depending on antenna type)
RET connector:	1 pair of AISG 5 pin male & female
Pin assignment according AISG:	8 pin circular connector conforming to IEC 60130-9 - Ed. 3.0
Lightning protection (kA):	5 (8/20 μs Differential mode), 8 (8/20 μs Common mode)

Typical Patterns

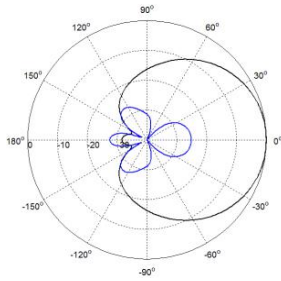

Azimuth(Low Band)

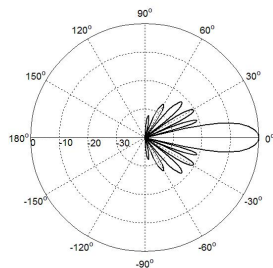

Elevation(Low Band)

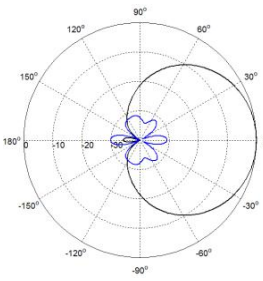

Azimuth(High Band)

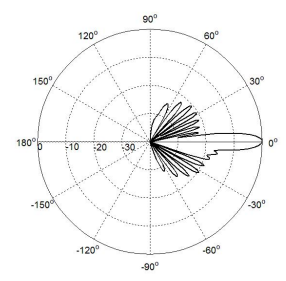

Elevation(High Band)

Bottom View

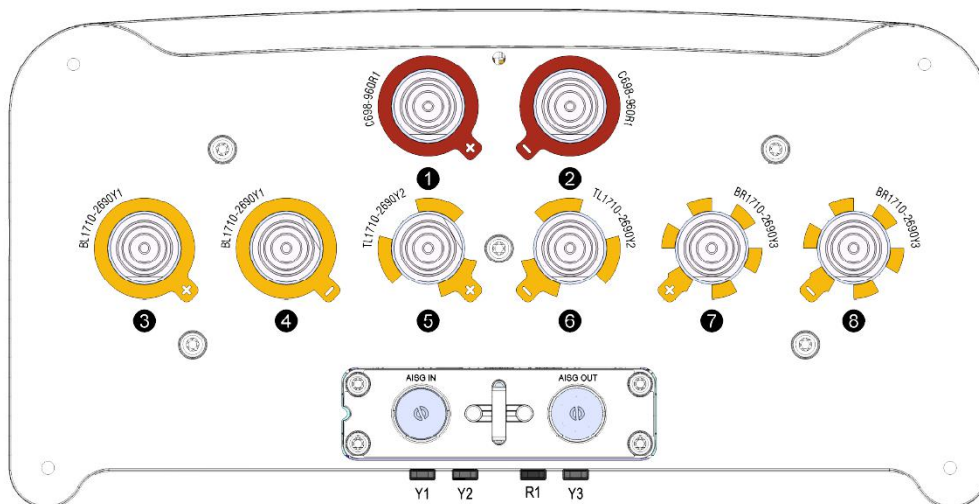

UL3PX309.10P-C

Correlation Table

Frequency range	Array	Connector	RET S/N
698–960MHz	R1	1-2	BRxxx.....1R1
1710–2690MHz	Y1	3-4	BRxxx.....2Y1
1710–2690MHz	Y2	5-6	BRxxx.....3Y2
1710–2690MHz	Y3	7-8	BRxxx.....4Y3

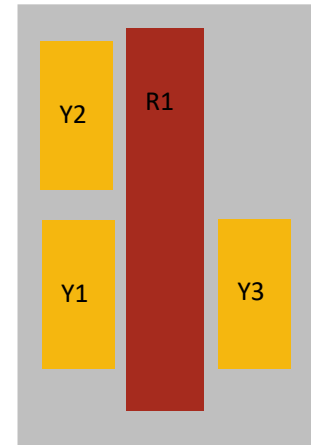

Product Data Sheet

U2L2PX307.10P-E2-C

XXXX Pol Panel Antenna 2×698-960/2×1710-2690MHz 65°/65° 15.5/17.5dBi 2°-12°/2°-12°

Replaceable RET

Electrical Specifications

Frequency Range (MHz):	698-960(R1,R2)			1710-2690(Y1,Y2)		
	698-806	806-880	880-960	1710-2170	2300-2490	2490-2690
Gain (dBi):	14.3±0.5	14.8±0.5	15.3±0.5	16.3±0.5	17.3±0.5	17.0±0.5
Return Loss (dB):	>14 (VSWR<1.5)					
Polarization:	±45°					
Horizontal 3dB beamwidth (°):	70	65	60	68	62	58
Vertical 3dB beamwidth (°):	11.0	10.5	9.5	7.5	6.0	5.3
Electrical Downtilt (°):	2-12 Independently Continuously Adjustable			2-12 Independently Continuously Adjustable		
RET Type:	Cascade SRET, AISG 2.0, Upgradeable					
1 st Upper Sidelobe Level (dB):	15	15	15	15	15	15
Front to Back Ratio @180±30°(dB):	22	23	24	25	25	25
Cross Polar Ratio 0° (dB):	15	15	15	15	15	15
Cross Polar Ratio 60° (dB):	10	9	8	9	8	7
Intraband Isolation (dB):	>25					
Interband Isolation (dB):	>28					
Max. Power Per Port (W):	250			200		
Intermodulation IM3 (dBC):	<-150 (2×43 dBm)					
Impedance (ohm):	50					
Lightning Protection:	DC Grounded					
Connector Type:	8×4.3-10 Female					

Mechanical Data

Antenna Dimensions (mm):	1820×448×185
Packing Dimensions (mm):	2160×535×280
Antenna Net Weight/Bracket (kg):	30/5.9
Antenna Gross Weight (kg):	41
Radome Material:	Fiberglass
Pipe OD (mm):	50-114
Mounting Kits (Included):	BA.K.04.00069121, Adjustable Downtilt 0°-14°

Environmental Ratings

Humidity:	95%RH@+30°C
Temperature (°C):	-50~+60
Wind Load @150 km/h (N):	Frontal/Lateral/Rearside: 784/193/930
Max. Wind velocity(km/h)	200

Internal RET Specifications

RET type:	Replaceable RET
RET protocol:	AISG2.0 /3GPP
Input voltage range(V):	10-30 DC
Power consumption(W):	< 5 (motor activated , single RET) < 1 (stand by, single RET), < 1.5 (stand by, 12V)
Adjustment time (full range) (s):	< 120 (typically, depending on antenna type)
RET connector:	1 pair of AISG 5 pin male & female
Pin assignment according AISG:	8 pin circular connector conforming to IEC 60130-9 - Ed. 3.0
Lightning protection (kA):	5 (8/20 μs Differential mode), 8 (8/20 μs Common mode)

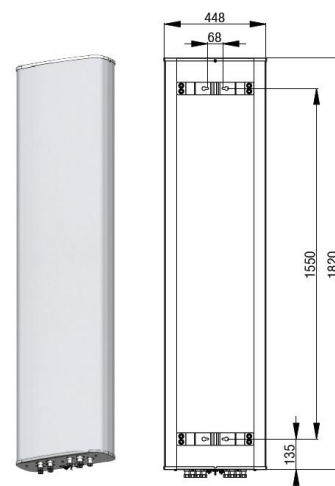

U2L2PX307.10P-E2-C

Typical Patterns

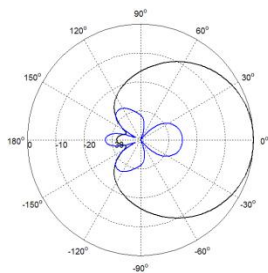

Azimuth(Low Band)

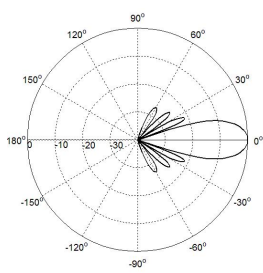

Elevation(Low Band)

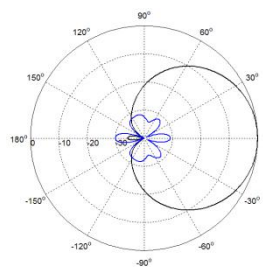

Azimuth(High Band)

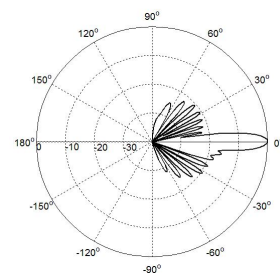

Elevation(High Band)

Bottom View

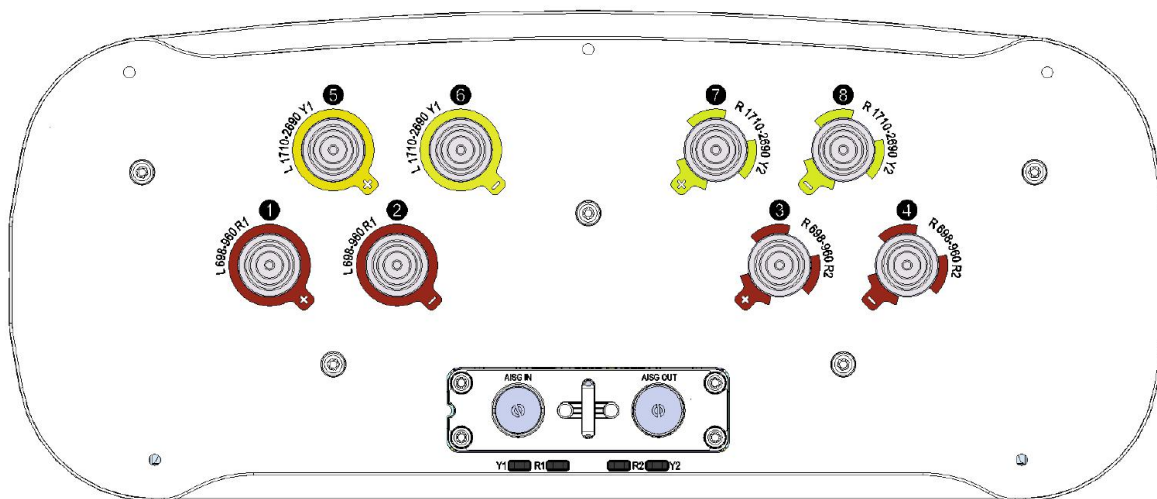

Correlation Table

Frequency range	Array	Connector	RET S/N
698– 960MHz	R1	1-2	BRxxx.....1R1
698– 960MHz	R2	3-4	BRxxx.....2R2
1710–2690MHz	Y1	5-6	BRxxx.....3Y1
1710–2690MHz	Y2	7-8	BRxxx.....4Y2

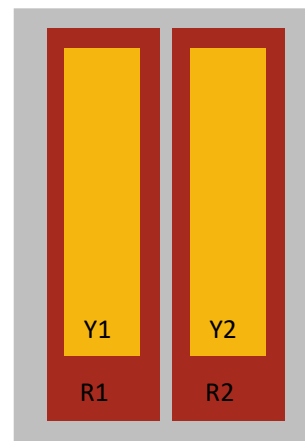

Product Data Sheet

U2L2PX309.10P-E2-C

XXXX Pol Panel Antenna 2×698-960/2×1710-2690MHz 65°/65° 17/17.5dBi 2°-12°/2°-12°

Replaceable RET

Electrical Specifications

Frequency Range (MHz):	698-960(R1,R2)			1710-2690(Y1,Y2)		
	698-806	806-880	880-960	1710-2170	2300-2490	2490-2690
Gain (dBi):	15.5±0.5	16.0±0.5	16.5±0.5	16.3±0.5	17.3±0.5	17.0±0.5
Return Loss (dB):	>14 (VSWR<1.5)					
Polarization:	±45°					
Horizontal 3dB beamwidth (°):	69	64	60	69	62	58
Vertical 3dB beamwidth (°):	8.5	7.0	6.5	7.5	6.0	5.3
Electrical Downtilt (°):	2-12 Independently Continuously Adjustable			2-12 Independently Continuously Adjustable		
RET Type:	Cascade SRET, AISG 2.0, Upgradeable					
1 st Upper Sidelobe Level (dB):	15	15	15	15	15	15
Front to Back Ratio @180±30°(dB):	22	23	24	25	25	25
Cross Polar Ratio 0° (dB):	15	15	15	15	15	15
Intraband Isolation (dB):	>25					
Interband Isolation (dB):	>28					
Max. Power Per Port (W):	250			200		
Intermodulation IM3 (dBc):	<-150 (2×43 dBm)					
Impedance (ohm):	50					
Lightning Protection:	DC Grounded					
Connector Type:	8×4.3-10 Female					

Mechanical Data

Antenna Dimensions (mm):	2250×448×185
Packing Dimensions (mm):	2520×535×280
Antenna Net Weight/Bracket (kg):	35.9/5.9
Antenna Gross Weight (kg):	47.5
Radome Material:	Fiberglass
Pipe OD (mm):	50-114
Mounting Kits (Included):	BA.K.04.00069291, Adjustable Downtilt 0°-8°

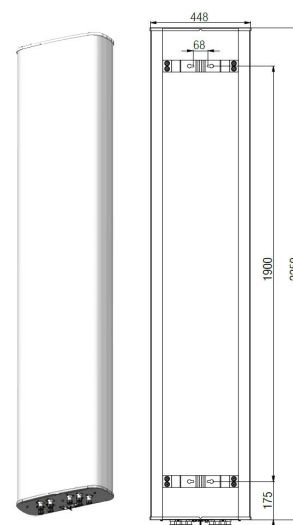

Environmental Ratings

Humidity:	95%RH@+30°C
Temperature (°C):	-40~+70
Wind Load @150 km/h (N):	Frontal/Lateral/Rearside: 978/244/1160
Max. Wind velocity(km/h)	200

Internal RET Specifications

RET type:	Replaceable RET
RET protocol:	AISG2.0 /3GPP
Input voltage range(V):	10-30 DC
Power consumption(W):	< 5 (motor activated , single RET) < 1 (stand by, single RET), < 1.5 (stand by, 12V)
Adjustment time (full range) (s):	< 120 (typically, depending on antenna type)
RET connector:	1 pair of AISG 5 pin male & female
Pin assignment according AISG:	8 pin circular connector conforming to IEC 60130-9 - Ed. 3.0
Lightning protection (kA):	5 (8/20 μs Differential mode), 8 (8/20 μs Common mode)

U2L2PX309.10P-E2-C

Typical Patterns

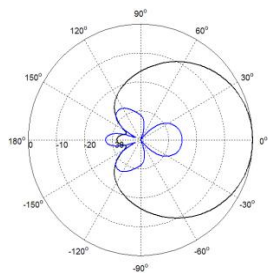

Azimuth(Low Band)

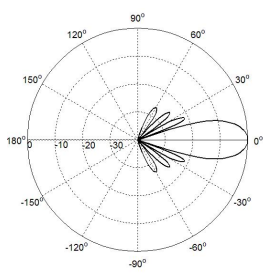

Elevation(Low Band)

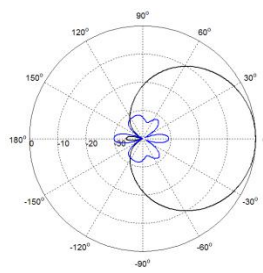

Azimuth(High Band)

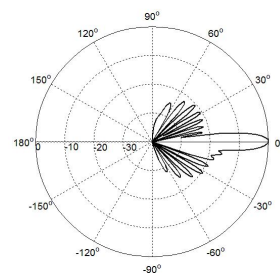

Elevation(High Band)

Correlation Table

Frequency range	Array	Connector	RET S/N
698–960MHz	R1	1-2	BRxxx.....1R1
698–960MHz	R2	3-4	BRxxx.....2R2
1710–2690MHz	Y1	5-6	BRxxx.....3Y1
1710–2690MHz	Y2	7-8	BRxxx.....4Y2

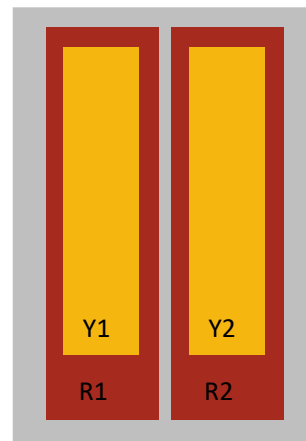

Product Data Shee

UL4PX306.7P-C

XXXXX Pol Panel Antenna 694-960/2×1710-2690/2×1710-2690MHz 65°/65°/65° 15/15.5/16dBi
0°-10°/0°-10°/0°-10° Replaceable RET

Electrical Specifications

Frequency Range (MHz):	694-960(R1)			1710-2690(Y1,Y3)			1710-2690(Y2,Y4)		
	694-806	806-880	880-960	1710-2170	2300-2490	2490-2690	1710-2170	2300-2490	2490-2690
Gain (dBi):	14.3 ±0.5	15.0 ±0.5	15.2 ±0.5	15.3 ±0.5	15.6 ±0.5	16.0 ±0.5	15.0 ±0.5	15.3 ±0.5	15.6 ±0.5
Return Loss (dB):	>14 (VSWR<1.5)								
Polarization:	±45°								
Horizontal 3dB Beamwidth (°):	72	68	65	68	65	57	66	62	57
Vertical 3dB Beamwidth (°):	15	13.5	11.2	10	8	7	10	8	7
Electrical Downtilt (°):	0-10 Independently Continuously Adjustable			0-10 Independently Continuously Adjustable					
RET Type:	Cascade SRET, AISG 2.0, Upgradeable								
1 st Upper Sidelobe Suppression (dB):	15	15	15	15	15	15	15	15	15
Front to Back Ratio (dB):	22	24	24	25	25	25	25	25	25
Cross Polar Ratio 0°(dB):	15	15	15	15	15	15	15	15	15
Intraband Isolation (dB):	>26								
Interband Isolation (dB):	>28								
Max. Power Per Port (W):	250			200					
Intermodulation IM3 (dBc):	<-150(2×43dBm)								
Impedance (ohm):	50								
Lightning Protection:	DC Grounded								
Connector Type:	10×4.3-10 Female								

BASTA Electrical Specification

Frequency Range(MHz):	694-960(R1)			1710-2690(Y1,Y3)		
	694-806	806-880	880-960	1710-2170	2300-2490	2490-2690
Average Gain by all Beam Tilts (dBi):	14.5	14.9	15.2	15	15.9	16
Gain by all Beam Tilts Tolerance(dB):	±0.7	±0.5	±0.4	±0.8	±0.4	±0.5
Average Gain by Beam Tilt (dBi):	0° 14.5	0° 14.8	0° 15.2	0° 15	0° 15.8	0° 16
	5° 14.8	5° 15.2	5° 15.4	5° 15.2	5° 16.1	5° 16.2
	10° 14.2	10° 14.6	10° 14.9	10° 14.7	10° 15.7	10° 15.8
Horizontal Beamwidth Tolerance(°):	±2.4	±2	±1.5	±7.1	±5.7	±5.2
Vertical Beamwidth Tolerance(°):	±1.1	±0.8	±0.5	±1.5	±0.5	±0.4
USLS to 20° above beampeak(dB):	15.3	13.7	13.8	15	15.5	15.6
Front to back Ratio at 180° ± 30°(dB)	24.8	25	23.8	26.7	28.1	28.6
CPR at Boresight(dB):	16	18.4	18	20.2	19.8	20.8

BASTA Electrical Specification

Frequency Range(MHz):	1710-2690(Y2,Y4)		
	1710-2170	2300-2490	2490-2690
Average Gain by all Beam Tilts (dBi):	14.6	15.4	15.6
Gain by all Beam Tilts Tolerance(dB):	±0.7	±0.5	±0.5
Average Gain by Beam Tilt (dBi):	0° 14.6	0° 15.5	0° 15.7
	5° 14.7	5° 15.7	5° 15.8
	10° 14.4	10° 15.2	10° 15.4
Horizontal Beamwidth Tolerance(°):	±6.0	±5.0	±4.7

Product Data Shee

UL4PX306.7P-C

Vertical Beamwidth Tolerance(°):	±1.1	±0.5	±0.4
USLS to 20° above beampeak(dB):	16.4	16.8	16.5
Front to back Ratio at 180° ± 30°(dB)	25.8	28	27.3
CPR at Boresight(dB):	17.2	17.7	19.9

Mechanical Data

Antenna Dimensions(mm):	1650×339×169
Packing Dimensions (mm):	1990×425×260
Antenna Net Weight/Bracket(kg):	23/5.7
Antenna Gross Weight(kg):	32
Radome Material:	Fiberglass
Pipe OD (mm):	70-114
Mounting Kits (Included):	BA.K.04.00069101, Adjustable Downtilt 0°-12°
Connector Type:	10×4.3-10 Female



Environmental Ratings

Humidity:	95%RH@+30℃
Temperature (°C):	-40~+70
Wind Load @150 km/h (N):	Frontal/Lateral/Rearside:714/238/870
Max. Wind velocity(km/h):	200

Internal RET Specifications

RET type:	Replaceable RET
RET protocol:	AISG 2.0 /3 GPP
Input voltage range(V):	10-30 DC
Power consumption(W):	< 5 (motor activated, single RET) < 1 (stand by, single RET), < 1.5 (stand by, 12V)
Adjustment time (full range) (s):	< 120 (typically, depending on antenna type)
RET connector:	1 pair of AISG 5 pin male & female
Pin assignment according AISG:	8 pin circular connector conforming to IEC 60130-9 - Ed. 3.0
Lightning protection (kA):	5 (8/20 μs Differential mode), 8 (8/20 μs Common mode)

Typical Patterns

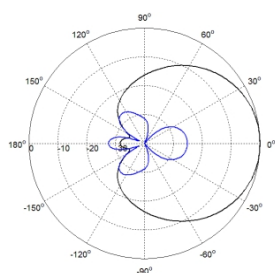

Azimuth(Low Band)

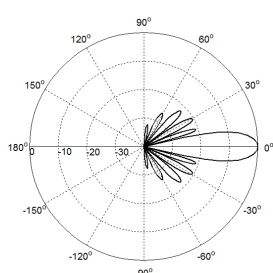

Elevation(Low Band)

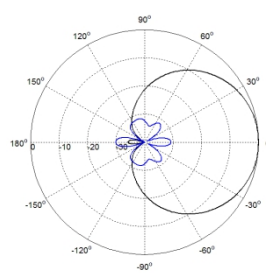

Azimuth(High Band)

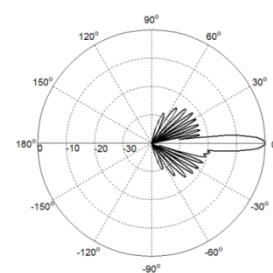

Elevation(High Band)

UL4PX306.7P-C

Bottom View

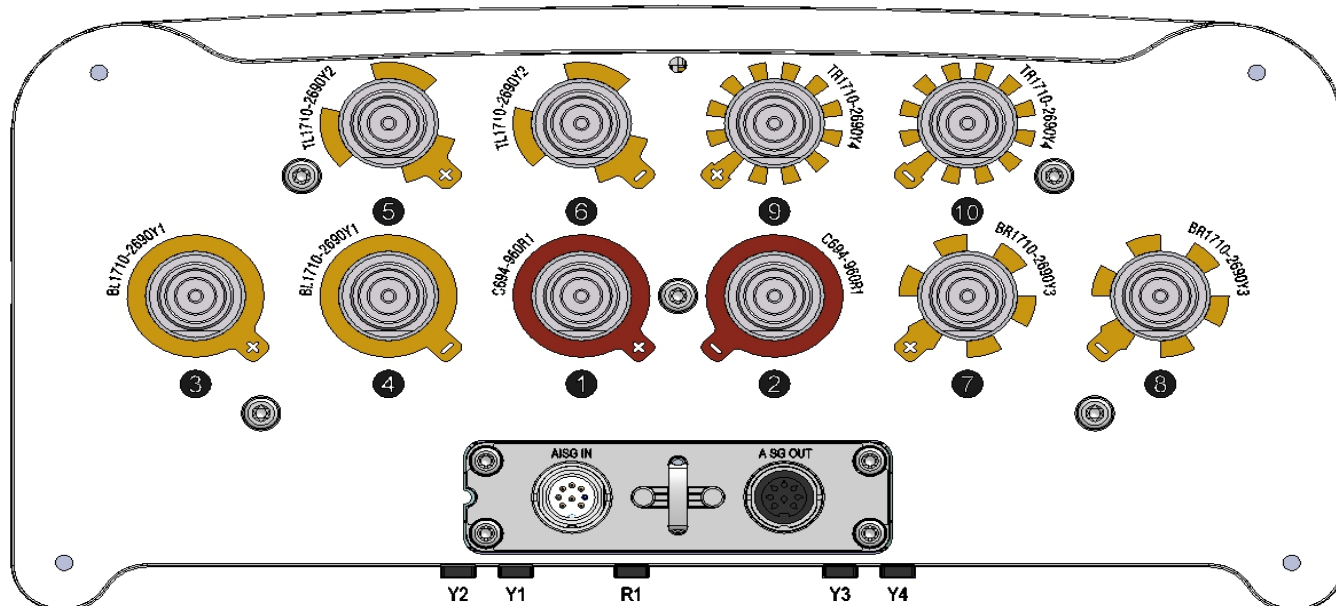

Correlation Table

Frequency range	Array	Connector	RET S/N
694-960 MHz	R1	1-2	BRxxx.....1R1
1710-2690 MHz	Y1	3-4	BRxxx.....2Y1
1710-2690 MHz	Y2	5-6	BRxxx.....3Y2
1710-2690 MHz	Y3	7-8	BRxxx.....4Y3
1710-2690 MHz	Y4	9-10	BRxxx.....5Y4

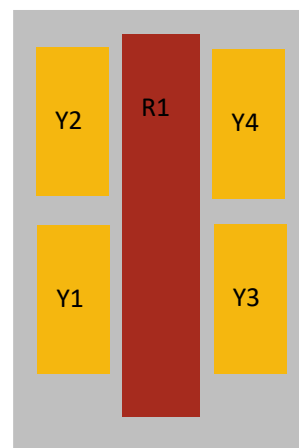

Product Data Sheet

UL4PX307.8P-C-V1

XXXXX Pol Panel Antenna 694-960/2×1710-2690/2×1710-2690MHz 65°/65°/65° 16/16.5/16dBi
0°-10°/0°-10°/0°-10° Replaceable RET

Electrical Specifications

Frequency Range (MHz):	694-960(R1)			1710-2690(Y1,Y3)			1710-2690(Y2,Y4)		
	694-806	806-880	880-960	1710-2170	2300-2490	2490-2690	1710-2170	2300-2490	2490-2690
Gain (dBi):	14.7 ±0.5	15.4 ±0.5	15.7 ±0.5	15.5 ±0.5	16.3 ±0.5	16.5 ±0.5	15.1 ±0.5	15.8 ±0.5	16.0 ±0.5
Return Loss (dB):	>14 (VSWR<1.5)								
Polarization:	±45°								
Horizontal 3dB Beamwidth (°):	69	65	62	68	62	57	68	62	57
Vertical 3dB Beamwidth (°):	13	11.5	10.2	9	8	7	9	8	7
Electrical Downtilt (°):	0-10 Independently Continuously Adjustable			0-10 Independently Continuously Adjustable					
RET Type:	Cascade SRET, AISG 2.0, Upgradeable								
1 st Upper Sidelobe Suppression (dB):	15	15	15	15	15	15	15	15	15
Front to Back Ratio (dB):	22	24	24	25	25	25	25	25	25
Cross Polar Ratio 0°(dB):	15	15	15	15	15	15	15	15	15
Intraband Isolation (dB):	Tilt 0°-2°: >26 Tilt 3°-10°: >28			>28			>28		
Interband Isolation (dB):	>28								
Max. Power Per Port (W):	250			200					
Intermodulation IM3 (dBc):	<-150(2×43dBm)								
Impedance (ohm):	50								
Lightning Protection:	DC Grounded								

BASTA Electrical Specification

Frequency Range(MHz):	694-960(R1)			1710-2690(Y1,Y3)		
	694-806	806-880	880-960	1710-2170	2300-2490	2490-2690
Average Gain by all Beam Tilts (dBi):	14.9	15.2	15.5	15.4	16.1	16.4
Gain by all Beam Tilts Tolerance(dB):	±0.7	±0.6	±0.5	±0.7	±0.4	±0.5
Average Gain by Beam Tilt (dBi):	0° 14.8	0° 15.1	0° 15.4	0° 15.2	0° 16.0	0° 16.3
	5° 15.1	5° 15.4	5° 15.7	5° 15.5	5° 16.2	5° 16.6
	10° 14.6	10° 14.9	10° 15.2	10° 15.0	10° 15.7	10° 16.0
Horizontal Beamwidth Tolerance(°):	±3.2	±2.1	±1.8	±7.3	±4.9	±4.7
Vertical Beamwidth Tolerance(°):	±0.7	±0.6	±0.4	±1.3	±0.8	±0.6
USLS to 20° above beampeak(dB):	15.8	15.1	14.7	15.3	15.1	15.9
Front to back Ratio at 180° ± 30°(dB)	26.1	27.6	27.8	25.9	29.1	30.2
CPR at Boresight(dB):	16.9	19.3	18.2	17.8	19.8	20.1

BASTA Electrical Specification

Frequency Range(MHz):	1710-2690(Y2,Y4)		
	1710-2170	2300-2490	2490-2690
Average Gain by all Beam Tilts (dBi):	15.4	15.9	16.1
Gain by all Beam Tilts Tolerance(dB):	±0.4	±0.7	±0.7
Average Gain by Beam Tilt (dBi):	0° 15.2	0° 15.8	0° 16.1
	5° 15.6	5° 16.2	5° 16.3
	10° 15.0	10° 15.6	10° 15.7
Horizontal Beamwidth Tolerance(°):	±5.5	±4.0	±3.5



Product Data Shee

UL4PX307.8P-C-V1

Vertical Beamwidth Tolerance(°):	±1.3	±0.4	±0.7
USLS to 20° above beampeak(dB):	15.5	15.4	16.1
Front to back Ratio at 180° ± 30°(dB)	26.7	28.2	29.3
CPR at Boresight(dB):	17.1	19.4	21.2

Mechanical Data

Antenna Dimensions(mm):	1960×339×169
Packing Dimensions (mm):	2280×425×260
Antenna Net Weight/Bracket(kg):	28/5.9
Antenna Gross Weight(kg):	37
Radome Material:	Fiberglass
Pipe OD (mm):	50-115
Mounting Kits (Included):	BA.K.04.00069121, Adjustable Downtilt 0°-14°
Connector Type:	10×4.3-10 Female



Environmental Ratings

Humidity:	95%RH@+30°C
Temperature (°C):	-40~+70
Wind Load @150 km/h (N):	Frontal/Lateral/Rearside: 854/288/1041
Max.Wind velocity(km/h):	200

Internal RET Specifications

RET type:	Replaceable RET
RET protocol:	AISG2.0 /3GPP
Input voltage range(V):	10-30 DC
Power consumption(W):	< 5 (motor activated , single RET) < 1 (stand by, single RET), < 1.5 (stand by, 12V)
Adjustment time (full range) (s):	< 120 (typically, depending on antenna type)
RET connector:	pair of AISG 5 pin male & female
Pin assignment according AISG:	8pin circular connector conforming to IEC 60130-9 - Ed. 3.0
Lightning protection (kA):	5 (8/20 μs Differential mode), 8 (8/20 μs Common mode)

Typical Patterns

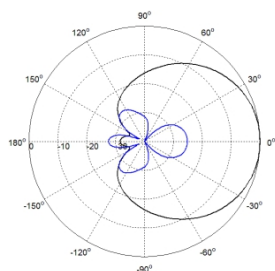

Azimuth(Low Band)

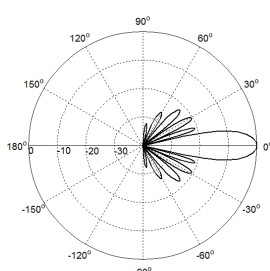

Elevation(Low Band)

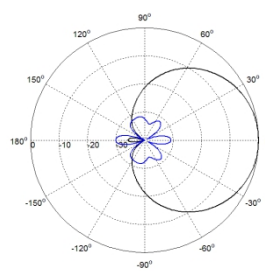

Azimuth(High Band)

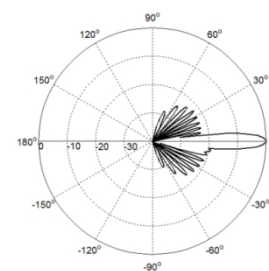

Elevation(High Band)



UL4PX307.8P-C-V1

Bottom View

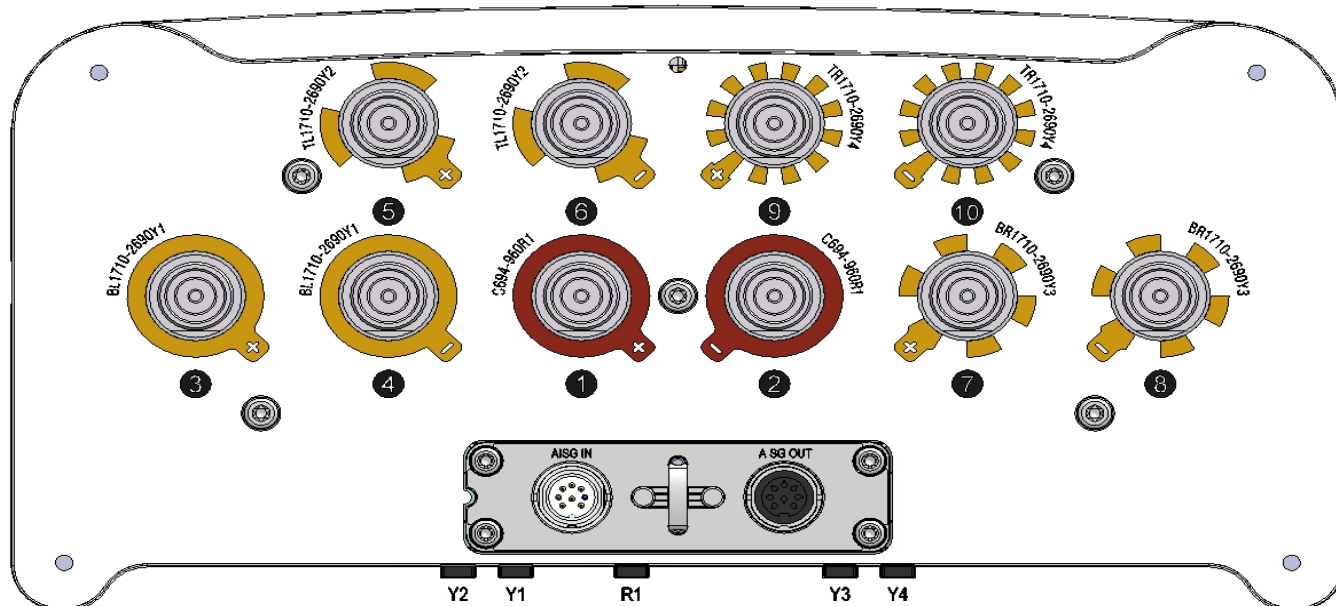

Correlation Table

Frequency range	Array	Connector	RET S/N
694-960 MHz	R1	1-2	BRxxx.....1R1
1710-2690 MHz	Y1	3-4	BRxxx.....2Y1
1710-2690 MHz	Y2	5-6	BRxxx.....3Y2
1710-2690 MHz	Y3	7-8	BRxxx.....4Y3
1710-2690 MHz	Y4	9-10	BRxxx.....5Y4

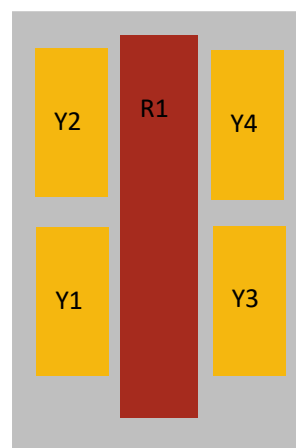

Product Data Sheet

U2L3PX307.10P-E2-C

XXXXX Pol Panel Antenna 2×698-960/3×1710-2690MHz 65°/65° 16/17dBi 2°-12° Replaceable RET
4.3-10 Connector

Electrical Specifications

Frequency Range (MHz):	698-960(R1,R2)			1710-2690(Y1,Y2,Y3)		
	698-806	806-880	880-960	1710-2170	2300-2490	2490-2690
Gain (dBi):	14.6±0.5	15.2±0.5	15.6±0.5	16.2±0.5	16.8±0.5	17.0±0.5
Return Loss (dB):	>14 (VSWR<1.5)					
Polarization:	±45°					
Horizontal 3dB beamwidth(°):	70	65	58	68	65	58
Vertical 3dB beamwidth (°):	12.0	11.0	10.0	7.0	6.0	5.5
Electrical Downtilt (°):	2-12Independently Continuously Adjustable					
1 st Upper Sidelobe Suppression(dB):	15	15	15	15	15	15
Front to BackRatio@180±30°	22	23	24	25	25	25
Cross Polar Ratio 0° (dB):	15	15	15	15	15	15
Intraband Isolation (dB):	>25					
Interband Isolation (dB):	>25					
Max. Power Per Port (W):	250			200		
Intermodulation IM3 (dBc):	<-150 (2×43 dBm)					
Impedance (ohm):	50					
Lightning Protection:	DC Grounded					
Connector Type:	10×4.3-10 Female					

Mechanical Data

Antenna Dimensions (mm):	1900×448×185
Packing Dimensions (mm):	2170×535×280
Antenna Net Weight /Bracket(kg):	34/5.9
Antenna Gross Weight (kg):	45
Radome Material:	Fiberglass
Pipe OD (mm):	50-115
Mounting Kits (Included):	BA.K.04.00069121, Adjustable Downtilt 0°-14°

Environmental Ratings

Humidity:	95%RH@+30℃
Temperature (℃):	-40~+70
Wind Load @150 km/h (N):	Frontal/Lateral/Rearside:820/200/973
Max Wind velocity(km/h):	200



Product Data Sheet

U2L3PX307.10P-E2-C

Internal RET Specifications

RET type:	Replaceable RET
RET protocol:	AISG 2.0 /3 GPP
Input voltage range(V):	10-30 DC
Power consumption(W):	< 5 (motor activated , single RET) < 1 (stand by, single RET), < 1.5 (stand by, 12V)
Adjustment time (full range) (s):	< 120 (typically, depending on antenna type)
RET connector:	1 pair of AISG 5 pin male & female
Pin assignment according AISG:	8 pin circular connector conforming to IEC 60130-9 - Ed. 3.0
Lightning protection (kA):	5 (8/20 μs Differential mode), 8 (8/20 μs Common mode)

Typical Patterns

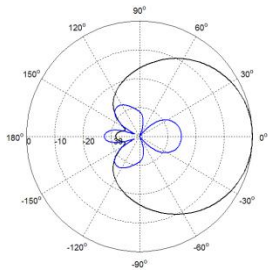

Azimuth(698-960MHz)

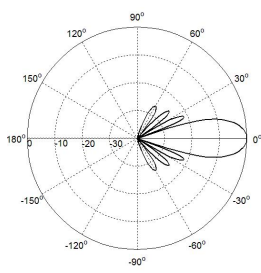

Elevation(698-960MHz)

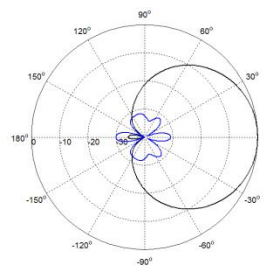

Azimuth(1710-2690MHz)

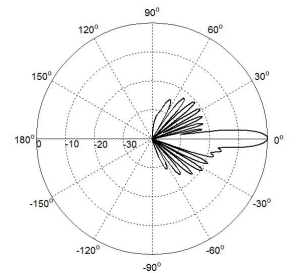

Elevation(1710-2690MHz)

Correlation Table

Frequency Range	Array	Connector
698– 960 MHz	R1	1-2
698– 960 MHz	R2	3-4
1710–2690 MHz	Y1	5-6
1710–2690 MHz	Y2	7-8
1710–2690 MHz	Y3	9-10

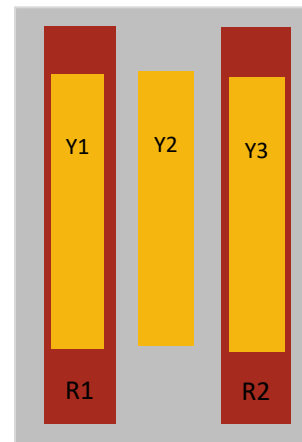

Product Data Sheet

L2H2PX310P-DH2-C

XXXXXX Pol Panel Antenna 2×1710-2170/2×2500-2690/2×2500-2690MHz 65°/65°/65°
16.5/17/17dBi 0°-10°Replaceable RET 4.3-10 Connector

Electrical Specifications

Frequency Range (MHz):	2×1710-2170(B1,B2)			2×2500-2690(Y1,Y4)
	1710-1880	1920-2025	2025-2170	2500-2690
Gain (dBi):	15.7±0.5	16.0±0.5	16.3±0.5	16.5±0.5
Return Loss (dB):	>14 (VSWR<1.5)			
Polarization:	±45°			
Horizontal 3dB Beamwidth (°):	69	66	63	58
Vertical 3dB Beamwidth (°):	8.0	7.5	7.0	5.5
Electrical Downtilt (°):	0-10 Independently Continuously Adjustable			
RET Type:	Cascade SRET, AISG2.0, Upgradeable			
1 st Upper Sidelobe Suppression (dB):	15	15	15	15
Front to Back Ratio (dB):	24	24	24	24
Cross Polar Ratio 0° (dB):	15	15	15	15
Isolation Port to Port (dB):	>26			
Max. Power Per Port (W):	200			
Intermodulation IM3 (dBc):	<-150 (2×43 dBm)			
Impedance (ohm):	50			
Lightning Protection:	DC Grounded			

Frequency Range (MHz):	2×2500-2690(Y2,Y3)
Gain (dBi):	16.5±0.5
Return Loss (dB):	>14 (VSWR<1.5)
Polarization:	±45°
Horizontal 3dB beamwidth (°):	58
Vertical 3dB beamwidth (°):	6.2
Electrical Downtilt (°):	0-10 Independently Continuously Adjustable
1 st Upper Sidelobe Suppression (dB):	15
Front to Back Ratio (dB):	24
Cross Polar Ratio 0° (dB):	15
Isolation Port to Port (dB):	>26
Max. Power Per Port (W):	200
Intermodulation IM3 (dBc):	<-150 (2×43dBm)
Impedance (ohm):	50
Lightning Protection:	DC Grounded



Product Data Sheet

L2H2PX310P-DH2-C

BASTA Electrical Specifications

Frequency Range(MHz):	2×1710-2170(B1,B2)		
	1710-1880	1920-2025	2025-2170
Average Gain by Beam Tilts (dBi):	0° 16.18	0° 16.31	0° 16.16
	5° 16.26	5° 16.60	5° 16.17
	10° 16.10	10° 16.42	10° 15.80
Gain by all Beam Tilts Tolerance(dB):	±0.28	±0.27	±0.38
Horizontal BeamwidthTolerance(°):	±2.58	±2.93	±2.51
Vertical Beamwidth Tolerance(°):	±0.41	±0.30	±0.46
Upper Side Lobe Suppression, Peak to 20°(dB):	15.03	16.19	15.56
Front to back Total Power at 180° ± 30°(dB)	24.52	25.11	24.86
CPR at Boresight(dB):	16.17	19.01	22.32

Frequency Range(MHz):	2×2500-2690(Y1,Y4)	2×2500-2690(Y2,Y3)
	2500-2690	2500-2690
Average Gain by Beam Tilts (dBi):	0° 16.54	0° 16.57
	5° 16.45	5° 16.51
	10° 16.14	10° 16.23
Gain by all Beam Tilts Tolerance(dB):	±0.51	±0.41
Horizontal BeamwidthTolerance(°):	±3.02	±2.95
Vertical Beamwidth Tolerance(°):	±0.44	±0.30
Upper Side Lobe Suppression, Peak to 20°(dB):	15.21	15.88
Front to back Total Power at 180° ± 30°(dB)	24.09	24.52
CPR at Boresight(dB):	15.60	17.47

Mechanical Data

Antenna Dimensions (mm):	2200×320×140
Packing Dimensions (mm):	2460×405×230
Antenna Net Weight/Bracket (kg):	23.5 / 5.9
Antenna Gross Weight (kg):	33.5
Connector Type:	12×4.3-10 Female
Radome Material:	Fiberglass
Pipe OD (mm):	50-115
Mounting Kits (Included):	BA.K.04.00069071, Adjustable Downtilt 0°-8°

Environmental Ratings

Humidity:	95%RH@+30℃
Temperature (℃):	-40~+70
Wind Load @150 km/h (N):	Frontal/Lateral/Rearside: 1029 / 298 / 965
Max. Wind velocity(km/h):	200

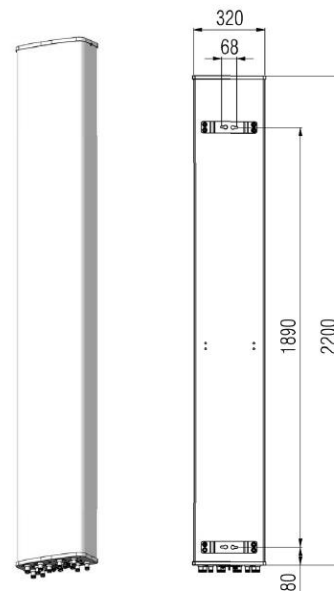

L2H2PX310P-DH2-C

Internal RET Specifications

RET type:	Replaceable RET
RET protocol:	AISG 2.0 /3 GPP
Input voltage range(V):	10-30 DC
Power consumption(W):	< 5 (motor activated, single RET) < 1 (stand by, single RET), < 1.5 (stand by, 12V)
Adjustment time (full range) (s):	< 120 (typically, depending on antenna type)
RET connector:	1 pair of AISG 5 pin male & female
Pin assignment according AISG:	8 pin circular connector conforming to IEC 60130-9 - Ed. 3.0
Lightning protection (kA):	5 (8/20 μs Differential mode), 8 (8/20 μs Common mode)

Typical Patterns

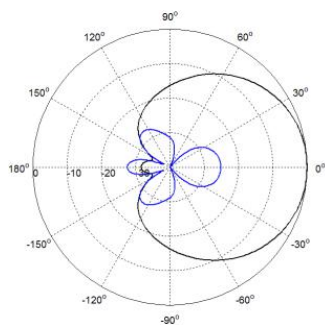

Azimuth

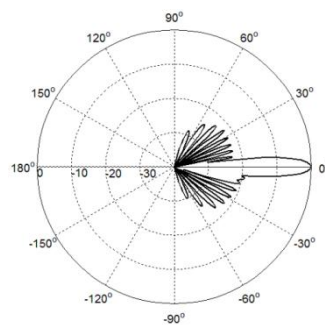

Elevation

Bottom View

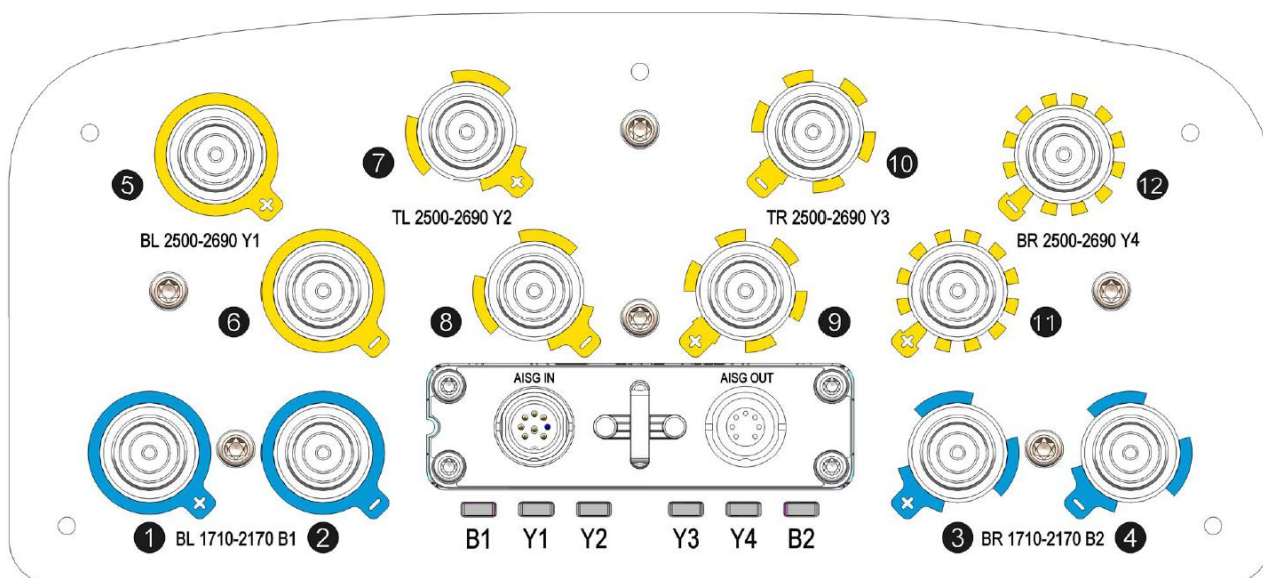

L2H2PX310P-DH2-C

Correlation Table

Frequency range	Array	Connector	RET S/N
1710–2170 MHz	B1	1-2	BRxxx.....1B1
1710–2170 MHz	B2	3-4	BRxxx.....2B2
2500–2690 MHz	Y1	5-6	BRxxx.....3Y1
2500–2690 MHz	Y2	7-8	BRxxx.....4Y2
2500–2690 MHz	Y3	9-10	BRxxx.....5Y3
2500–2690 MHz	Y4	11-12	BRxxx.....6Y4

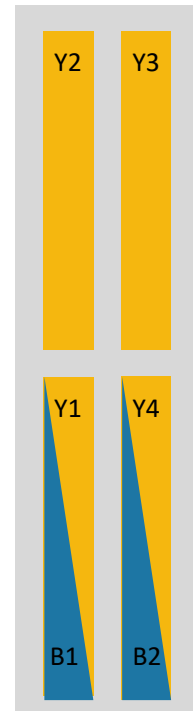

Product Data Sheet

U2L4PX305.10P-E2-C

XXXXXX Pol Panel Antenna 2×698-960/4×1710-2690MHz 65°/65° 14/17.5dBi 2°-12°/2°-12°

Replaceable RET

Electrical Specifications

Frequency Range (MHz):	698-960(R1,R2)			1710-2690(Y2,Y3)			1710-2690(Y1,Y4)		
	698-806	806-880	880-960	1710 -2170	2300 -2490	2490 -2690	1710 -2170	2300 -2490	2490 -2690
Gain (dBi):	13.2 ±0.5	13.7 ±0.5	14.2 ±0.5	16.3 ±0.5	17.3 ±0.5	17.0 ±0.5	16.0 ±0.5	17.0 ±0.5	16.7 ±0.5
Return Loss (dB):	>14 (VSWR<1.5)								
Polarization:	±45°								
Horizontal 3dB Beamwidth (°):	70	65	60	68	62	58	68	62	58
Vertical 3dB Beamwidth (°):	19.5	18	16.5	7.5	6.0	5.3	7.5	6.0	5.3
Electrical Downtilt (°):	2-12 Independently Continuously Adjustable			2-12 Independently Continuously Adjustable					
1 st Upper Sidelobe Suppression (dB):	15	15	15	15	15	15	15	15	15
Front to Back Ratio @180±30°(dB):	22	23	24	25	25	25	25	25	25
Cross Polar Ratio 0° (dB):	15	15	15	15	15	15	15	15	15
Cross Polar Ratio 60° (dB):	10	9	8	9	8	7	9	8	7
Intraband Isolation (dB):	>25								
Interband Isolation (dB):	>25								
Max. Power Per Port (W):	250			200					
Intermodulation IM3 (dBc):	<-150(2×43 dBm)								
Impedance (ohm):	50								
Lightning Protection:	DC Grounded								
Connector Type:	12×4.3-10 Female								

Mechanical Data

Antenna Dimensions (mm):	1395×498×197
Packing Dimensions (mm):	1665×585×290
Antenna Net Weight/Bracket (kg):	27/5.9
Antenna Gross Weight (kg):	38
Radome Material:	Fiberglass
Pipe OD (mm):	50-115
Mounting Kits (Included):	BA.K.04.00069151 ,Adjustable Downtilt 0°-20°

Environmental Ratings

Humidity:	95%RH@+30℃
Temperature (℃):	-40~+70
Wind Load @150 km/h (N):	Frontal/Lateral/Rearside:887/158/900
Max. Wind velocity(km/h):	200

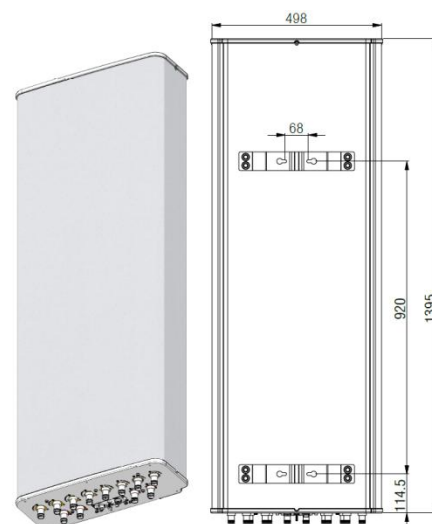

Product Data Sheet

U2L4PX305.10P-E2-C

Internal RET Specifications

RET type:	Replaceable RET
RET protocol:	AISG2.0 /3GPP
Input voltage range(V):	10-30 DC
Power consumption(W):	< 5 (motor activated ,single RET) < 1 (stand by,single RET), < 1.5 (stand by, 12V)
Adjustment time (full range) (s):	< 120 (typically, depending on antenna type)
RET connector:	1 pair of AISG 5 pin male & female
Pin assignment according AISG:	8pin circular connector conforming to IEC 60130-9 - Ed. 3.0
Lightning protection (kA):	5 (8/20 μ s Differential mode), 8 (8/20 μ s Common mode)

Typical Patterns

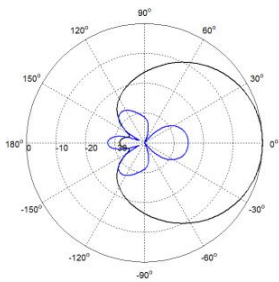

Azimuth(Low Band)

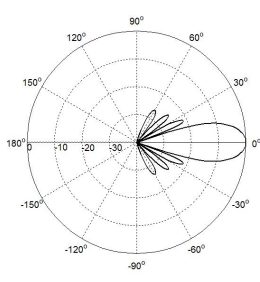

Elevation(Low Band)

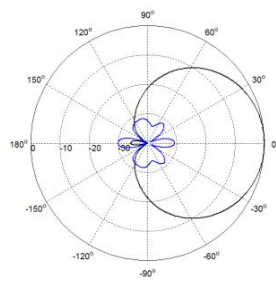

Azimuth(High Band)

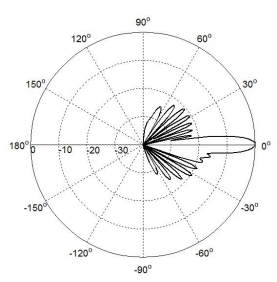

Elevation(High Band)

Bottom View

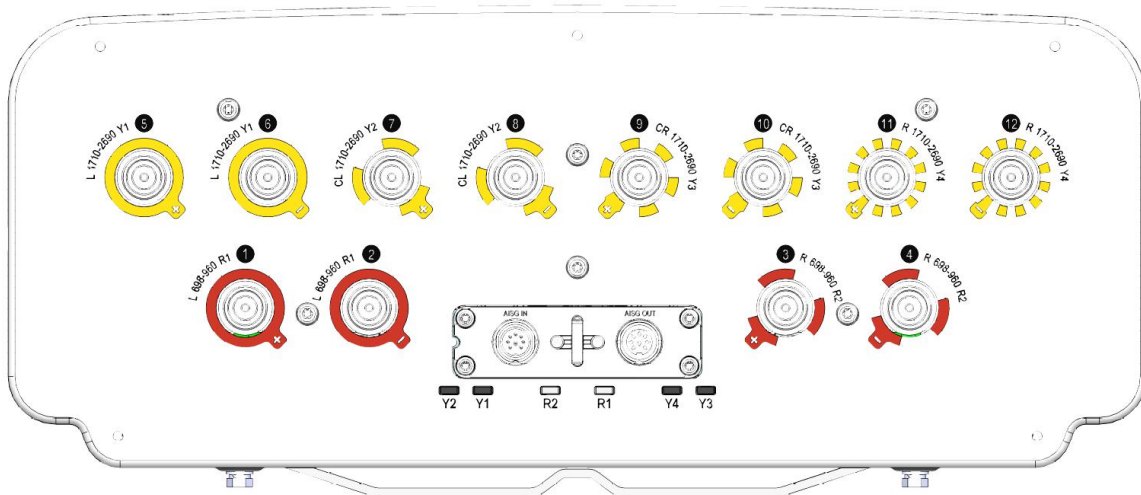

Correlation Table

Frequency range	Array	Connector
698–960 MHz	R1	1-2
698–960 MHz	R2	3-4
1710–2690 MHz	Y1	5-6
1710–2690 MHz	Y2	7-8
1710–2690 MHz	Y3	9-10
1710–2690 MHz	Y4	11-12

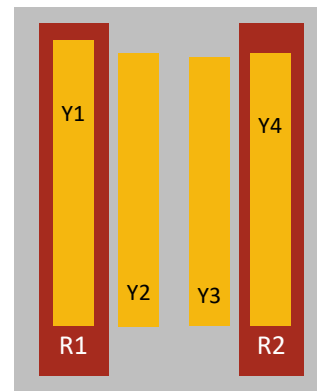

Product Data Sheet

U2L4PX307.10P-2C

XXXXXX Pol Panel Antenna 2×698-960/4×1710-2690MHz 65°/65° 15.5/18dBi 2-12°/2-12°

Replaceable RET

Electrical Specifications

Frequency Range (MHz):	698-960(R1,R2)			1710-2690(Y1,Y4)			1710-2690(Y2,Y3)		
	698-806	806-880	880-960	1710-2170	2300-2490	2490-2690	1710-2170	2300-2490	2490-2690
Gain (dBi):	14.2 ±0.5	14.9 ±0.5	14.7 ±0.5	16.4 ±0.5	16.9 ±0.5	16.8 ±0.5	16.2 ±0.5	17.0 ±0.5	16.7 ±0.5
Return Loss (dB):	>14 (VSWR<1.5)								
Polarization:	±45°								
Horizontal 3dB Beamwidth (°):	64	59	61	68	64	61	68	63	62
Vertical 3dB Beamwidth (°):	11.7	10.2	9.3	7.3	6.2	5.6	7.3	6.2	5.5
Electrical Downtilt (°):	2-12 Independently Continuously Adjustable								
RET Type:	Cascade SRET, AISG 2.0, Upgradeable								
1 st Upper Sidelobe Suppression (dB):	15	15	14	16	15	15	16	15	15
Intraband Isolation (dB):	>25								
Interband Isolation (dB):	>25								
Max. Power Per Port (W):	250			200					
Intermodulation IM3 (dBc):	<-150(2×43 dBm)								
Impedance (ohm):	50								
Lightning Protection:	DC Grounded								
Connector Type:	12×4.3-10 Female								

BASTA Electrical Specifications

Frequency Range(MHz):	698-960(R1,R2)		
	698-806	806-880	880-960
Average Gain by Beam Tilts (dBi):	14.1	14.7	14.6
Gain by all Beam Tilts Tolerance(dB):	±0.9	±0.5	±0.5
Average Gain by Beam Tilts (dBi):	2° 14.1 7° 14.2 12° 13.8	2° 14.6 7° 14.9 12° 14.6	2° 14.5 7° 14.7 12° 14.6
Horizontal Beamwidth Tolerance(°):	±7.9	±5.3	±5.0
Vertical Beamwidth Tolerance(°):	±0.9	±0.5	±0.6
Upper Side Lobe Suppression, Peak to 20°(dB):	13.8	13.5	13.0
Front to back Total Power at 180° ± 30°(dB)	20.0	22.1	22.0
CPR at Boresight(dB):	19.8	19.4	19.0



Product Data Sheet

U2L4PX307.10P-2C

BASTA Electrical Specifications

Frequency Range(MHz):	1710-2690(Y1,Y4)			1710-2690(Y2,Y3)		
	1710-2170	2300-2490	2490-2690	1710-2170	2300-2490	2490-2690
Average Gain by Beam Tilts (dBi):	16.2	16.6	16.4	16.1	16.9	16.5
Gain by all Beam Tilts Tolerance(dB):	±0.5	±0.6	±0.9	±0.5	±0.6	±0.6
Average Gain by Beam Tilts (dBi):	2° 16.4	2° 16.9	2° 16.8	2° 16.0	2° 17.2	2° 16.6
	7° 16.2	7° 16.6	7° 16.4	7° 16.2	7° 17.0	7° 16.7
	12° 16.1	12° 16.2	12° 15.9	12° 16.0	12° 16.4	12° 16.0
Horizontal Beamwidth Tolerance(°):	±5.2	±2.8	±4.9	±5.6	±4.8	±9.8
Vertical Beamwidth Tolerance(°):	±0.8	±0.3	±0.4	±0.6	±0.3	±0.4
Upper Side Lobe Suppression, Peak to 20°(dB):	14.7	14.5	14.6	14.3	14.6	14.4
Front to back Total Power at 180° ± 30°(dB)	25.5	29.6	24.1	25.6	28.7	25.7
CPR at Boresight(dB):	19.0	19.0	19.1	19.6	19.1	15.1

Mechanical Data

Antenna Dimensions (mm):	2000×498×197
Packing Dimensions (mm):	2270×585×290
Antenna Net Weight/Bracket (kg):	34/5.9
Antenna Gross Weight (kg):	46
Radome Material:	Fiberglass
Pipe OD (mm):	50-115
Mounting Kits (Included):	BA.K.04.00069121, Adjustable Downtilt 0-14°

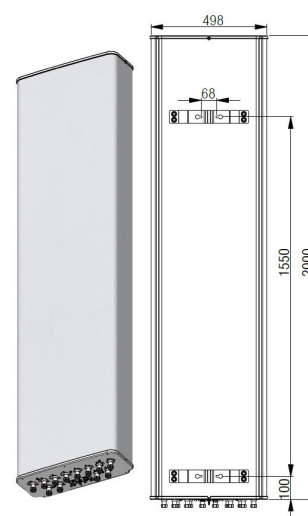

Environmental Ratings

Humidity:	95%RH@+30°C
Temperature (°C):	-40~+70
Wind Load @150 km/h (N):	Frontal/Lateral/: 1292/229/1310
Max.Wind velocity(km/h):	200

Internal RET Specifications

RET type:	Replaceable RET
RET protocol:	AISG2.0 /3GPP
Input voltage range(V):	10-30 DC
Power consumption(W):	< 5 (motor activated, single RET) < 1 (stand by, single RET), < 1.5 (stand by, 12V)
Adjustment time (full range): (s):	< 120 (typically, depending on antenna type)
RET connector:	1 pair of AISG 5 pin male & female
Pin assignment according AISG:	8 pin circular connector conforming to IEC 60130-9 - Ed. 3.0
Lightning protection (kA):	5 (8/20 μs Differential mode), 8 (8/20 μs Common mode)

Typical Patterns

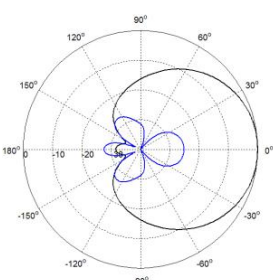

Azimuth(Low band)

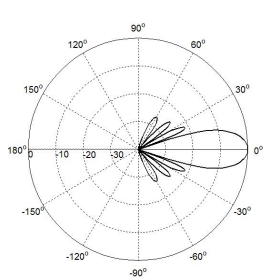

Elevation(Low band)

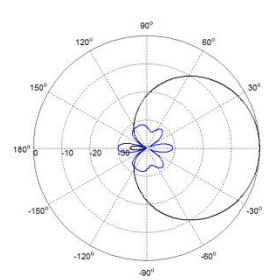

Azimuth(High band)

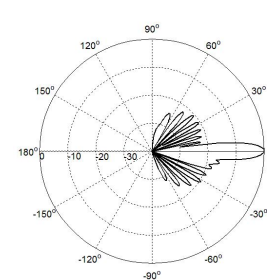

Elevation(High band)

U2L4PX307.10P-2C

Bottom View

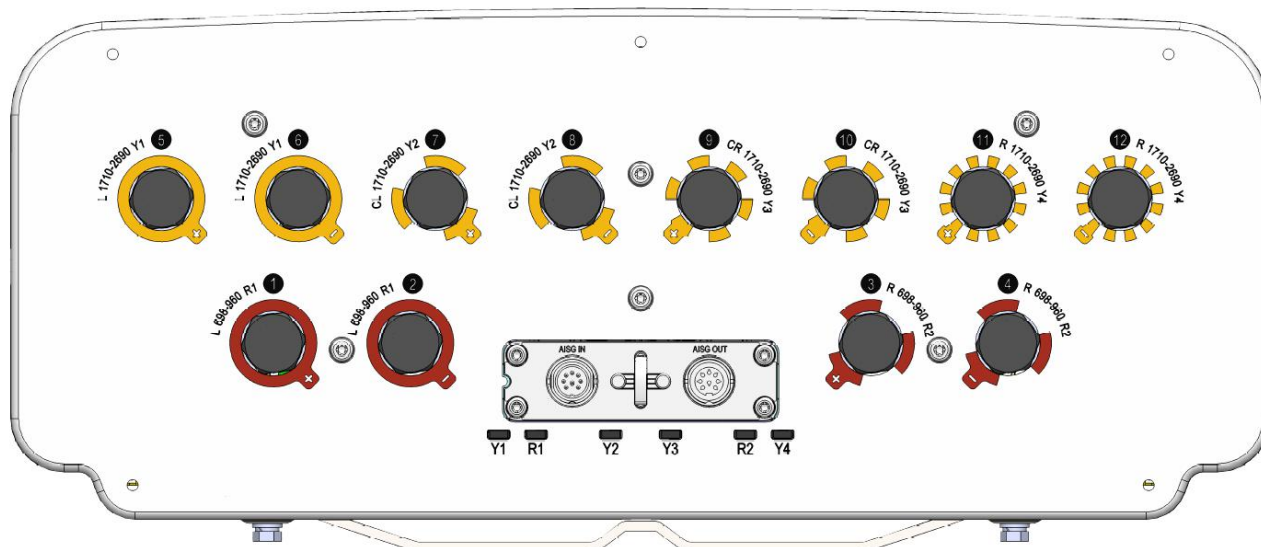

Correlation Table

Frequency range	Array	Connector	RET S/N
698–960 MHz	R1	1-2	BRxxx.....1R1
698–960 MHz	R2	3-4	BRxxx.....2R2
1710–2690 MHz	Y1	5-6	BRxxx.....3Y1
1710–2690 MHz	Y2	7-8	BRxxx.....4Y2
1710–2690 MHz	Y3	9-10	BRxxx.....5Y3
1710–2690 MHz	Y4	11-12	BRxxx.....6Y4

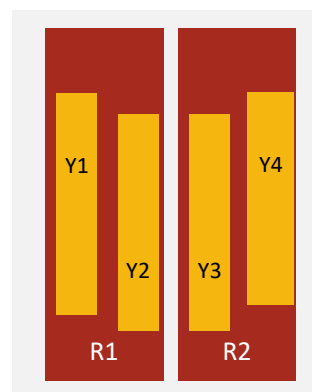

Product Data Sheet

U2L4PX309.10P-E2-C

XXXXXX Pol Panel Antenna 2×698-960/4×1710-2690MHz 65°/65° 17/17.5dBi 2°-12°/2°-12°
Replaceable RET

Electrical Specifications

Frequency Range (MHz):	698-960(R1,R2)			1710-2690(Y1,Y3)			1710-2690(Y2,Y4)		
	698-806	806-880	880-960	1710 -2170	2300 -2490	2490 -2690	1710 -2170	2300 -2490	2490 -2690
Gain (dBi):	15.5 ±0.5	16.0 ±0.5	16.5 ±0.5	16.3 ±0.5	17.3 ±0.5	17.0 ±0.5	16.0 ±0.5	17.0 ±0.5	16.7 ±0.5
Return Loss (dB):	>14 (VSWR<1.5)								
Polarization:	±45°								
Horizontal 3dB Beamwidth (°):	69	64	60	69	62	58	69	62	58
Vertical 3dB Beamwidth (°):	8.5	7.0	6.5	7.5	6.0	5.3	7.5	6.0	5.3
Electrical Downtilt (°):	2-12 Independently Continuously Adjustable			2-12 Independently Continuously Adjustable					
RET Type:	Cascade SRET, AISG 2.0, Upgradeable								
1 st Upper Sidelobe Suppression (dB):	15	15	15	15	15	15	15	15	15
Front to Back Ratio (dB):	22	23	24	25	25	25	25	25	25
Cross Polar Ratio 0° (dB):	15	15	15	15	15	15	15	15	15
Intraband Isolation (dB):	>25								
Interband Isolation (dB):	>28								
Power Rating (W):	250			200					
Intermodulation IM3 (dBc):	<-150(2×43 dBm)								
Impedance (ohm):	50								
Lightning Protection:	DC Grounded								
Connector Type:	12×4.3-10 Female								

Mechanical Data

Antenna Dimensions (mm):	2630×448×185
Packing Dimensions (mm):	2890×530×275
Antenna Net Weight/Bracket (kg):	44 / 5.9
Antenna Gross Weight (kg):	56
Radome Material:	Fiberglass
Pipe OD (mm):	50-115
Mounting Kits (Included):	BA.K.04.00069311, Adjustable Downtilt 0°-10°

Environmental Ratings

Humidity:	95%RH@+30°C
Temperature (°C):	-40~+70
Wind Load @150 km/h (N):	Frontal/Lateral/Rearside: 1151/293/1365
Max. Wind velocity(km/h):	200

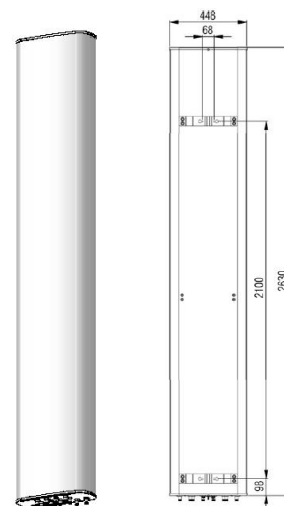

U2L4PX309.10P-E2-C

Internal RET Specifications

RET type:	Replaceable RET
RET protocol:	AISG 2.0 /3 GPP
Input voltage range(V):	10-30 DC
Power consumption(W):	< 5 (motor activated ,single RET) < 1 (stand by, single RET), < 1.5 (stand by, 12V)
Adjustment time (full range) (s):	< 120 (typically, depending on antenna type)
RET connector:	1 pair of AISG 5 pin male & female
Pin assignment according AISG:	8 pin circular connector conforming to IEC 60130-9 - Ed. 3.0
Lightning protection (kA):	5 (8/20 μ s Differential mode), 8 (8/20 μ s Common mode)

Typical Patterns

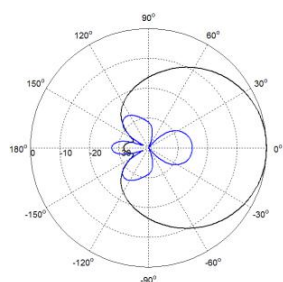

Azimuth(Low Band)

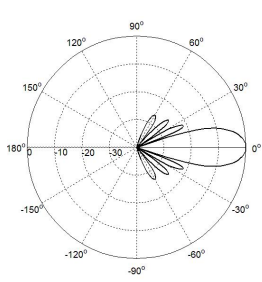

Elevation(Low Band)

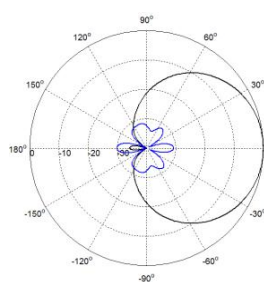

Azimuth(High Band)

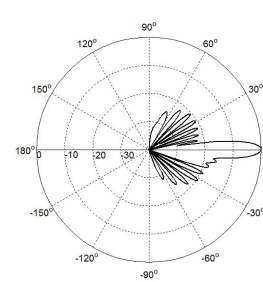

Elevation(High Band)

Bottom View

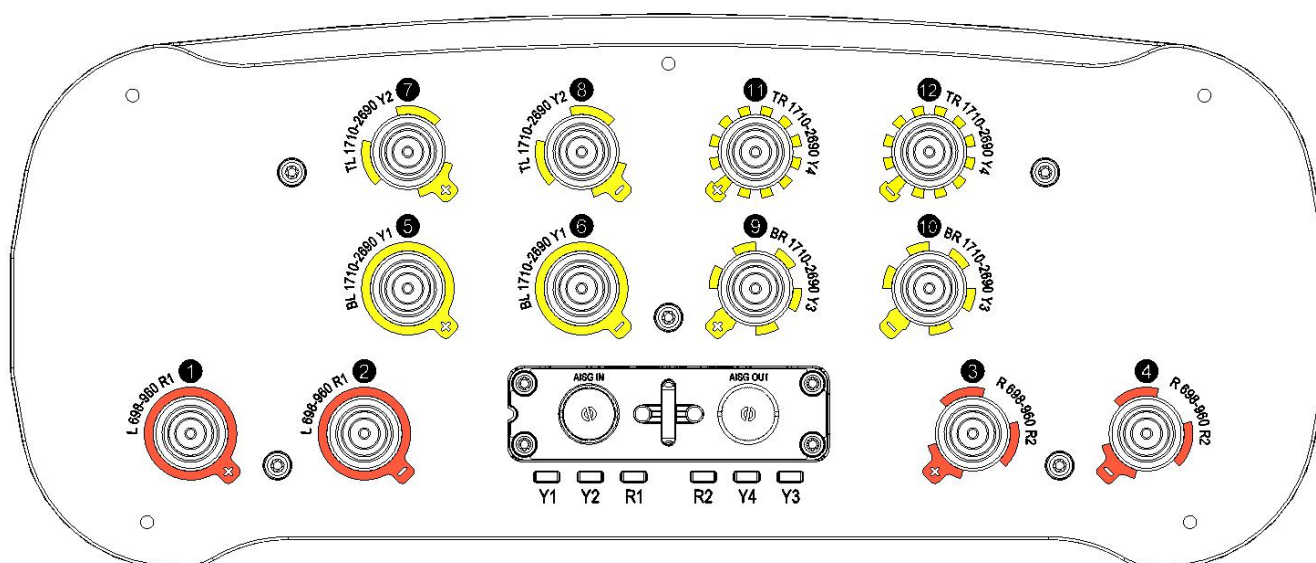

Correlation Table

Frequency range	Array	Connector
698–960 MHz	R1	1-2
698–960 MHz	R2	3-4
1710–2690 MHz	Y1	5-6
1710–2690 MHz	Y2	7-8
1710–2690 MHz	Y3	9-10
1710–2690 MHz	Y4	11-12

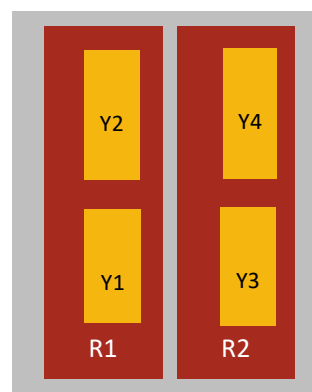

Product Data Sheet

U2L2PX307.10P-DHH-C

XXXXXX Pol Panel Antenna 2×698-960/2×1710-2170/2×2490-2690MHz 65°/65°/65° 15.5/16/16.5dBi
0°-10°/0°-10°/0°-10° Replaceable RET 4.3-10 Connector

Electrical Specifications

Frequency Range (MHz):	698-960(R1,R2)			1710-2170(B1,B2)			2490-2690
	698-806	806-880	880-960	1710-1880	1880-2025	2025-2170	(Y1,Y2)
Gain (dBi):	14.3±0.5	14.8±0.5	15.3±0.5	15.5±0.5	15.7±0.5	16.0±0.5	16.3±0.5
Return Loss (dB):	>14 (VSWR<1.5)						
Polarization:	±45°						
Horizontal 3dB Beamwidth (°):	70	65	56	68	65	63	58
Vertical 3dB Beamwidth(°):	11.5	10.5	9	7	6	5.5	4.5
Electrical Downtilt (°):	0-10 Independently Continuously Adjustable						
1 st Upper Sidelobe Suppression (dB):	15	15	15	15	15	15	15
Front to Back Ratio (dB):	25	25	25	25	25	25	25
Cross Polar Ratio 0°(dB):	15	15	15	15	15	15	15
Intraband Isolation (dB):	>25						
Interband Isolation (dB):	>28						
Average power tolerance (W):	250			200			
Intermodulation IM3 (dBc):	<-150 (2×43 dBm)						
Impedance (ohm):	50						
Lightning Protection:	DC Grounded						
Connector Type:	12×4.3-10 Female						

BASTA Electrical Specification

Frequency Range(MHz):	698-960(R1)			698-960(R2)			1710-2170(B1)			1710-2170(B2)			
	698-806	806-880	880-960	698-806	806-880	880-960	1710-1880	1880-2025	2025-2170	1710-1880	1880-2025	2025-2170	
Average Gain by all Beam Tilts (dBi):	14.1	14.7	15.2	14.2	14.8	15.3	15.3	15.5	15.7	15.4	15.5	15.6	
Gain by all Beam Tilts Tolerance(dB):	±0.3	±0.4	±0.4	±0.4	±0.4	±0.5	±0.6	±0.5	±0.9	±0.5	±0.4	±0.7	
Average Gain by Beam Tilt (dBi):	0°	14.2	14.8	15.2	14.2	14.8	15.2	15.3	15.4	15.8	15.4	15.5	15.6
	5°	14.4	15.0	15.5	14.4	15.1	15.5	15.5	15.7	15.9	15.6	15.7	15.8
	10°	13.6	14.2	14.6	13.7	14.5	15.0	15.2	15.6	15.6	15.3	15.3	15.5
Horizontal Beamwidth Tolerance(°):	±5.9	±2.2	±7.0	±4.8	±2.8	±6.4	±7.8	±5.4	±8.2	±6.4	±6.2	±7.9	
Vertical Beamwidth Tolerance(°):	±0.7	±0.8	±1.0	±0.5	±0.7	±1.1	±0.4	±0.7	±0.5	±0.5	±0.8	±0.6	
USLS to 20° above beampeak(dB):	15.2	15.6	16.1	15.3	16.2	16.4	16.5	16.4	16.2	15.8	16.2	15.7	
Front to back Ratio at 180° ± 30°(dB)	25.2	24.2	21.5	24.5	24.3	22.1	26.3	25.5	27.4	27.2	26.1	26.7	
CPR at Boresight(dB):	19.0	18.5	18.7	16.5	17.5	18.4	17.5	16.1	16.4	17.8	16.4	17.5	



Product Data Sheet

U2L2PX307.10P-DHH-C

Frequency Range(MHz):	2490-2690(Y1)			2490-2690(Y2)		
Average Gain by all Beam Tilts (dBi):	15.5	15.7	16.0	15.4	15.7	15.9
Gain by all Beam Tilts Tolerance(dB):	±0.4	±0.5	±0.4	±0.5	±0.7	±0.6
Average Gain by Beam Tilt (dBi):	0°	15.4	15.6	15.9	15.3	15.8
	5°	15.7	15.9	16.2	15.6	16.2
	10°	15.4	15.6	16.0	15.5	15.8
Horizontal Beamwidth Tolerance(°):	±4.7	±3.1	±6.2	±5.2	±3.7	±5.7
Vertical Beamwidth Tolerance(°):	±0.5	±0.6	±0.9	±0.8	±0.7	±1.2
USLS to 20° above beampeak(dB):	15.7	16.4	15.8	15.9	16.4	15.4
Front to back Ratio at 180° ± 30°(dB)	26.5	27.2	28.4	27.5	26.7	29.1
CPR at Boresight(dB):	17.4	18.7	17.2	17.2	18.9	18.5

Mechanical Data

Antenna Dimensions (mm):	1995×448×185
Packing Dimensions (mm):	2265×535×280
Antenna Net Weight/bracket (kg):	33/5.9
Antenna Gross Weight (kg):	44
Radome Material:	Fiberglass
Pipe OD (mm):	50-115
Mounting Kits (Included):	BA.K.04.00069121, Adjustable Downtilt 0°-14°

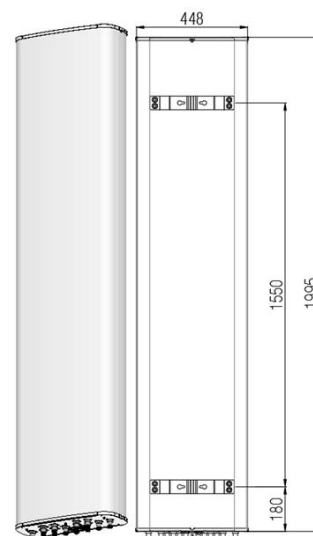

Environmental Ratings

Humidity:	95%RH@+30°C
Temperature (°C):	-40~+70
Wind Load @150 km/h (N):	Frontal/Lateral/Rearside: 863 / 212/ 1024
Max. Wind velocity(km/h):	200

Internal RET Specifications

RET Type:	Replaceable RET
RET protocol:	AISG2.0 /3GPP
Input voltage range(V):	10-30 DC
Power consumption (W):	< 5 (motor activated, single RET) < 1 (stand by, single RET), < 1.5 (stand by, 12V)
Adjustment time (full range) (s):	< 120 (typically, depending on antenna type)
RET connector:	1 pair of AISG 5 pin male & female
Pin assignment according AISG:	8pin circular connector conforming to IEC 60130-9 - Ed. 3.0
Lightning protection (kA):	5 (8/20 μs Differential mode), 8 (8/20 μs Common mode)

Typical Patterns

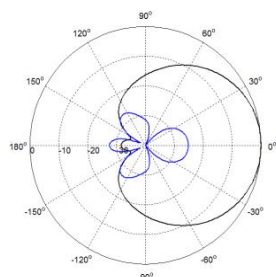

Azimuth(Low Band)

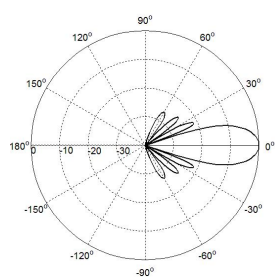

Elevation(Low Band)

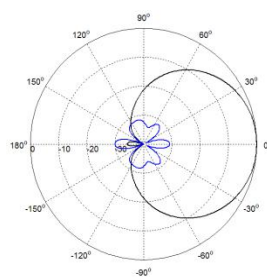

Azimuth(High Band)

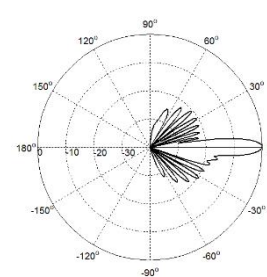

Elevation(High Band)

U2L2PX307.10P-DHH-C

Bottom View

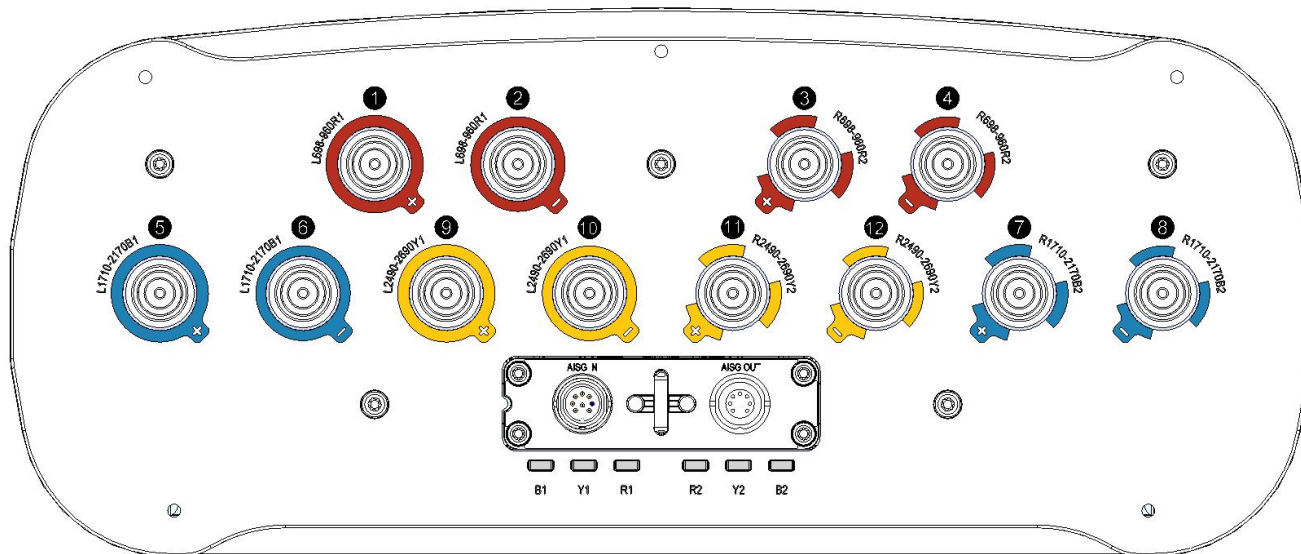

Correlation Table

Frequency range	Array	Connector	RET S/N
698– 960MHz	R1	1-2	BRxxx.....1R1
698– 960MHz	R2	3-4	BRxxx.....2R2
1710–2170MHz	B1	5-6	BRxxx.....3B1
1710–2170MHz	B2	7-8	BRxxx.....4B2
2490–2690MHz	Y1	9-10	BRxxx.....5Y1
2490–2690MHz	Y2	11-12	BRxxx.....6Y2

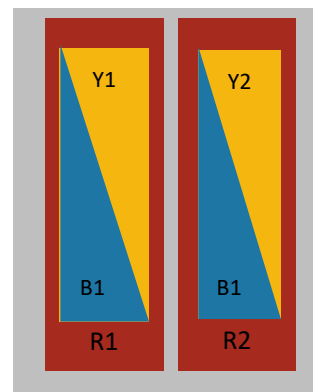

Product Data Sheet

U2L3PX307.10P-DHH-E2-C

XXXXXXX Pol Panel Antenna 2 × 694-960/1710-2690/2 × 1710-2170/2 × 2490-2690MHz
65°/65°/65°/65° 16/17.5/16/17dBi 2°-12° Replaceable RET

Electrical Specifications

Frequency Range (MHz):	2×694-960(R1,R2)			1710-2690(Y2)		
	694-806	806-880	880-960	1710-2170	2300-2490	2490-2690
Gain (dBi):	14.5±0.5	15.2±0.5	15.6±0.5	16.2±0.5	16.7±0.5	17.2±0.5
Return Loss (dB):	>14 (VSWR<1.5)					
Polarization:	±45°					
Horizontal 3dB Beamwidth (°):	68	65	58	68	65	58
Vertical 3dB Beamwidth (°):	12.5	11.5	10.5	7.5	6.0	5.5
Electrical Downtilt (°):	2-12 Independently Continuously Adjustable					
RET Type:	Cascade SRET, AISG 2.0 ,Upgradeable					
1 st Upper Sidelobe Suppression (dB):	15	15	15	15	15	15
Front to Back Ratio@180±30° (dB):	23	24	25	25	25	25
Cross Polar Ratio 0°(dB):	15	15	15	15	15	15
Intraband Isolation (dB):	25					
Interband Isolation (dB):	25					
Max. Power Per Port (W)	250			200		
Intermodulation IM3 (dBc):	<-150(2×43 dBm)					
Impedance (ohm):	50					
Lightning Protection:	DC Grounded					

Electrical Specifications

Frequency Range (MHz):	1710-2170(B1,B2)			2490-2690(Y1,Y3)
	1710-1880	1880-2025	2025-2170	2490-2690
Gain (dBi):	15.5±0.5	15.7±0.5	16.0±0.5	16.5±0.5
Return Loss (dB):	>14 (VSWR<1.5)			
Polarization:	±45°			
Horizontal 3dB Beamwidth (°):	68	65	60	58
Vertical 3dB Beamwidth (°):	8.0	7.5	7.0	5.5
Electrical Downtilt (°):	2-12 Independently Continuously Adjustable			
RET Type:	Cascade SRET, AISG2.0, Upgradeable			
1 st Upper Sidelobe Suppression (dB):	15	15	15	15
Front to Back Ratio@180±30° (dB):	25	25	25	25
Cross Polar Ratio 0°(dB):	15	15	15	15
Intraband Isolation (dB):	>25			
Interband Isolation (dB):	>25			
Max. Power Per Port (W):	200			
Intermodulation IM3 (dBc):	<-150 (2×43 dBm)			
Impedance (ohm):	50			
Lightning Protection:	DC Grounded			

Product Data Sheet

U2L3PX307.10P-DHH-E2-C

Mechanical Data

Antenna Dimensions (mm):	1900×448×185
Packing Dimensions (mm):	2035×515×320
Antenna Net Weight/Bracket (kg):	41/6.3
Antenna Gross Weight (kg):	54
Radome Material:	Fiberglass
Pipe OD (mm):	50-115
Mounting Kits (Included):	BA.K.04.00069121, Adjustable Downtilt 0-14°
Connector Type:	14×4.3-10 Female



Environmental Ratings

Humidity:	95%RH@+30℃
Temperature (℃):	-40~+70
Wind Load @150 km/h (N):	Frontal/Lateral/Rearside: 820/200/973
Max. Wind velocity(km/h):	200

Internal RET Specifications

RET type:	Replaceable RET
RET protocol:	AISG 2.0 /3 GPP
Input voltage range(V):	10-30 DC
Power consumption(W):	< 5 (motor activated , single RET) < 1 (stand by, single RET), < 1.5 (stand by, 12V)
Adjustment time (full range) (s):	< 120 (typically, depending on antenna type)
RET connector:	1 pair of AISG 5 pin male & female
Pin assignment according AISG:	8 pin circular connector conforming to IEC 60130-9 - Ed. 3.0
Lightning protection (kA):	5 (8/20 μs Differential mode), 8 (8/20 μs Common mode)

Typical Patterns

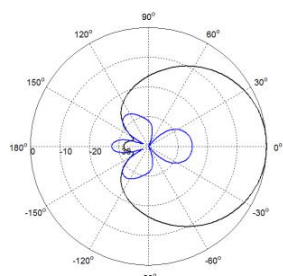

Azimuth(694-960MHz)

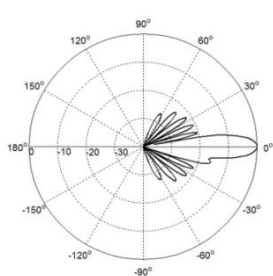

Elevation(694-960MHz)

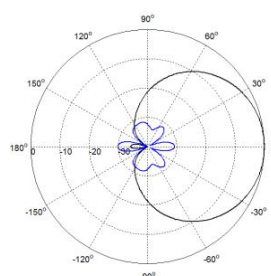

Azimuth(1695-2690MHz)

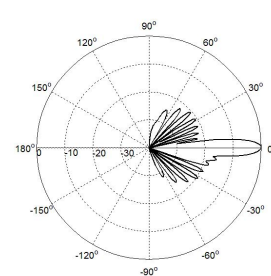

Elevation(1695-2690MHz)

Correlation Table

Frequency Range	Array	Connector
694– 960 MHz	R1	1-2
694– 960 MHz	R2	3-4
1710–2170 MHz	B1	5-6
1710–2170 MHz	B2	7-8
2490–2690 MHz	Y1	9-10
1710–2690 MHz	Y2	11-12
2490–2690 MHz	Y3	13-14

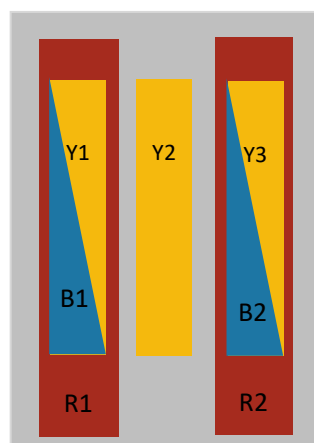

Product Data Sheet

U2L4PX305.10P-DHH-2C

XXXXXXXXX Pol Panel Antenna 2×694-960/2×1710-2170/2×2490-2690/2×1710-2690MHz
65°/65°/65°/65° 13/16.5/17/16.5dBi 2°-16°/2°-12°/2°-12°/2°-12° Replaceable RET

Electrical Specifications

Frequency Range (MHz):	694-960(R1,R2)			1710-2690(Y1,Y4)		
	694-806	806-880	880-960	1710-2170	2300-2490	2490-2690
Gain (dBi):	12.2±0.5	12.9±0.5	12.9±0.5	16.3±0.5	16.6±0.5	16.7±0.5
Return Loss (dB):	>14 (VSWR<1.5)					
Polarization:	±45°					
Horizontal 3dB Beamwidth (°):	66	63	64	68	66	61
Vertical 3dB Beamwidth (°):	18.7	16.7	15.4	7.7	6.4	5.5
Electrical Downtilt (°):	2-16 Independently Continuously Adjustable			2-12 Independently Continuously Adjustable		
RET Type:	Cascade SRET, AISG 2.0, Upgradeable					
1 st Upper Sidelobe Suppression (dB):	13	13	13	15	15	15
Intraband Isolation (dB):	>25					
Interband Isolation (dB):	>25					
Max. Power Per Port (W):	250			200		
Intermodulation IM3 (dBc):	<-150(2×43 dBm)					
Impedance (ohm):	50					
Lightning Protection:	DC Grounded					

Electrical Specifications

Frequency Range (MHz):	1710-2170(B1,B2)			2490-2690(Y2,Y3)
	1710-1880	1880-2025	2025-2170	2490-2690
Gain (dBi):	15.5±0.5	15.6±0.5	15.6±0.5	15.7±0.5
Return Loss (dB):	>14 (VSWR<1.5)			
Polarization:	±45°			
Horizontal 3dB Beamwidth (°):	69	68	66	65
Vertical 3dB Beamwidth (°):	8.0	7.5	7.0	5.5
Electrical Downtilt (°):	2-12 Independently Continuously Adjustable			
RET Type:	Cascade SRET, AISG2.0, Upgradeable			
1 st Upper Sidelobe Suppression (dB):	14	15	14	15
Intraband Isolation (dB):	>25			
Interband Isolation (dB):	>25			
Max. Power Per Port (W):	200			200
Intermodulation IM3 (dBc):	<-150 (2×43 dBm)			
Impedance (ohm):	50			
Lightning Protection:	DC Grounded			

Product Data Sheet

U2L4PX305.10P-DHH-2C

BASTA Electrical Specification

Frequency Range(MHz):	694-960(R1,R2)			1710-2690(Y1,Y4)		
	694-806	806-880	880-960	1710-2170	2300-2490	2490-2690
Average Gain by Beam Tilts (dBi):	12.1	12.8	12.7	16.1	16.3	16.2
Gain by all Beam Tilts Tolerance(dB):	±0.8	±0.7	±0.6	±0.5	±0.7	±0.7
Average Gain by Beam Tilts (dBi):	2° 122	2° 129	2° 129	2° 16.2	2° 16.5	2° 16.3
	9° 120	9° 12.8	9° 12.9	7° 16.3	7° 16.6	7° 16.7
	16° 120	16° 12.5	16° 12.3	12° 15.9	12° 15.9	12° 15.9
Horizontal Beamwidth Tolerance(°):	±10.0	±13.1	±10.8	±4.0	±6.4	±4.2
Vertical Beamwidth Tolerance(°):	±1.9	±1.2	±1.6	±0.8	±0.5	±0.4
Upper Side Lobe Suppression, Peak to 20°(dB):	13	13	13	15	15	14
Front to back Total Power at 180° ± 30°(dB)	20	21	21	25	25	25
CPR at Boresight(dB):	14	14	13	15	16	15

BASTA Electrical Specifications

Frequency Range(MHz):	1710-2170(B1,B2)			2490-2690(Y2,Y3)
	1710-1880	1880-2025	2025-2170	2490-2690
Average Gain by Beam Tilts (dBi):	15.3	15.5	15.4	15.4
Gain by all Beam Tilts Tolerance(dB):	±0.6	±0.5	±0.5	±1.0
Average Gain by Beam Tilts (dBi):	2° 15.5	2° 15.5	2° 15.2	2° 15.7
	7° 15.5	7° 15.6	7° 15.6	7° 15.6
	12° 15.0	12° 15.4	12° 15.5	12° 14.9
Horizontal Beamwidth Tolerance(°):	±8.7	±4.5	±5.4	±7.7
Vertical Beamwidth Tolerance(°):	±0.4	±0.4	±0.4	±0.4
Upper Side Lobe Suppression, Peak to 20°(dB):	14	15	14	15
Front to back Total Power at 180° ± 30°(dB)	25	25	25	25
CPR at Boresight(dB):	13	15	14	13

Mechanical Data

Antenna Dimensions (mm):	1495×498×197
Packing Dimensions (mm):	1805×580×290
Antenna Net Weight/Bracket (kg):	31/5.9
Antenna Gross Weight (kg):	42.5
Radome Material:	Fiberglass
Pipe OD (mm):	50-114
Mounting Kits (Included):	BA.K.04.00069131, Adjustable Downtilt 0°-16°
Connector Type:	16×4.3-10 Female

Environmental Ratings

Humidity:	95%RH@+30℃
Temperature (℃):	-40~+70
Wind Load @150 km/h (N):	Frontal/Lateral/Rearside: 1291/255/1361
Max.Wind velocity(km/h):	200



U2L4PX305.10P-DHH-2C

Internal RET Specifications

RET type:	Replaceable RET
RET protocol:	AISG2.0 /3GPP
Input voltage range(V):	10-30 DC
Power consumption(W):	< 5 (motor activated , single RET) < 1 (stand by, single RET), < 1.5 (stand by, 12V)
Adjustment time (full range) (s):	< 120 (typically, depending on antenna type)
RET connector:	1 pair of AISG 5 pin male & female
Pin assignment according AISG:	8 pin circular connector conforming to IEC 60130-9 - Ed. 3.0
Lightning protection (kA):	5 (8/20 μs Differential mode), 8 (8/20 μs Common mode)

Typical Patterns

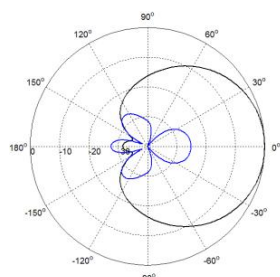

Azimuth(Low band)

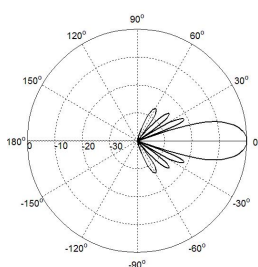

Elevation(Low band)

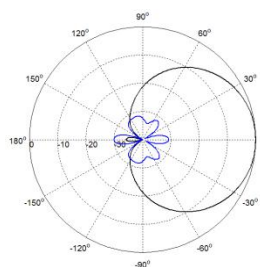

Azimuth(High band)

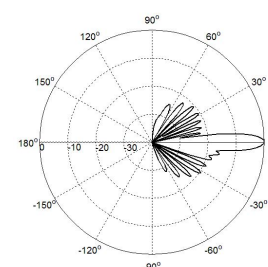

Elevation(High band)

Bottom View



Correlation Table

Frequency range	Array	Connector	RET S/N
694– 960 MHz	R1	1-2	BRxxx.....R1
694– 960 MHz	R2	3-4	BRxxx.....R2
1710–2170 MHz	B1	5-6	BRxxx.....B1
1710–2170 MHz	B2	7-8	BRxxx.....B2
1710–2690 MHz	Y1	9-10	BRxxx.....Y1
2490–2690 MHz	Y2	11-12	BRxxx.....Y2
2490–2690 MHz	Y3	13-14	BRxxx.....Y3
1710–2690 MHz	Y4	15-16	BRxxx.....Y4

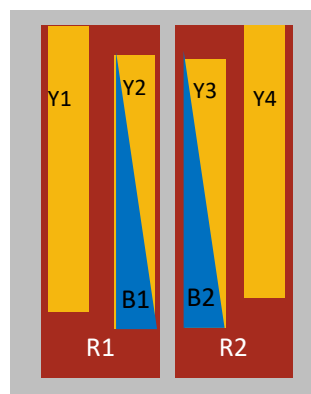

Product Data Sheet

U2L4PX308.10P-DH2-2C

XXXXXXXXX Pol Panel Antenna 2×698-960/2×1710-2170/2×2490-2690/2×1710-2690MHz
65°/65°/65°/65° 15/16/16/17dBi 2°-12°/2°-12°/2°-12°/2°-12° Replaceable RET

Electrical Specifications

Frequency Range (MHz):	694-960(R1,R2)			1710-2690(Y1,Y4)		
	698-806	806-880	880-960	1710-2170	2300-2490	2490-2690
Gain (dBi):	13.9	14.8	14.7	16.1	16.7	16.4
Return Loss (dB):	>14 (VSWR<1.5)					
Polarization:	±45°					
Horizontal 3dB Beamwidth (°):	62	60	62	70	63	61
Vertical 3dB Beamwidth (°):	11.6	10.3	9.6	7.5	6.0	5.5
Electrical Downtilt (°):	2-12 Independently Continuously Adjustable					
RET Type:	Cascade SRET, AISG 2.0, Upgradeable					
1 st Upper Sidelobe Suppression (dB):	14	14	14	15	15	15
Intraband Isolation (dB):	>25					
Max. Power Per Port (W)	250			200		
Intermodulation IM3 (dBC):	<-150(2×43 dBm)					
Impedance (ohm):	50					
Lightning Protection:	DC Grounded					

Frequency Range (MHz):	1710-2170(B1,B2)			2490-2690(Y2,Y3)
	1710-1880	1880-2025	2025-2170	2490-2690
Gain (dBi):	15.3	15.3	15.4	15.6
Return Loss (dB):	>14 (VSWR<1.5)			
Polarization:	±45°			
Horizontal 3dB Beamwidth (°):	70	69	66	62
Vertical 3dB Beamwidth (°):	7.7	7.3	7.0	5.5
Electrical Downtilt (°):	2-12 Independently Continuously Adjustable			
RET Type:	Cascade SRET, AISG2.0, Upgradeable			
1 st Upper Sidelobe Suppression (dB):	15	14	15	15
Intraband Isolation (dB):	>25			
Interband Isolation (dB):	>25			
Max. Power Per Port (W) :	200			200
Intermodulation IM3 (dBC):	<-150 (2×43 dBm)			
Impedance (ohm):	50			
Lightning Protection:	DC Grounded			

BASTA Electrical Specification

Frequency Range(MHz):	698-960(R1,R2)			1710-2690(Y1,Y4)		
	698-806	806-880	880-960	1710-2170	2300-2490	2490-2690
Average Gain by all Beam Tilts(dBi):	13.7	14.6	14.6	15.9	16.4	16.2
Gain by all Beam Tilts Tolerance(dB):	±0.8	±0.5	±0.5	±0.7	±0.6	±0.6
Average Gain by Beam Tilt (dBi):	2° 13.7	2° 14.5	2° 14.4	2° 16.0	2° 16.6	2° 16.4
	7° 13.9	7° 14.8	7° 14.7	7° 16.1	7° 16.7	7° 16.4
	12° 13.5	12° 14.4	12° 14.6	12° 15.7	12° 15.9	12° 15.8
3dB Horizontal Beamwidth Tolerance(°):	±9.0	±7.0	±5.7	±7.4	±5.7	±5.3
3dB Vertical Beamwidth Tolerance(°):	±0.9	±0.6	±0.6	±0.8	±0.5	±0.4
Upper Side Lobe Suppression, Peak to 20°(dB):	14	14	14	14	14	14
Front to back Total Power at 180° ± 30°(dB):	20	21	20	24	24	24
CPR at Boresight(dB):	15	15	15	15	15	15



U2L4PX308.10P-DH2-2C

Frequency Range(MHz):	1710-2170(B1,B2)			2490-2690(Y2,Y3)
	1710-1880	1880-2025	2025-2170	2490-2690
Average Gain by all Beam Tilts(dBi):	15.2	15.3	15.2	15.6
Gain by all Beam Tilts Tolerance(dB):	±0.4	±0.4	±0.6	±0.6
Average Gain by Beam Tilt (dBi):	2° 15.3	2° 15.3	2° 15.0	2° 15.7
	7° 15.3	7° 15.3	7° 15.4	7° 15.8
	12° 15.0	12° 15.2	12° 15.2	12° 15.2
3dB Horizontal Beamwidth Tolerance(°):	±6.0	±6.0	±6.0	±8.0
3dB Vertical Beamwidth Tolerance(°):	±0.4	±0.4	±0.4	±0.4
Upper Side Lobe Suppression, Peak to 20°(dB):	15	14	14	14
Front to back Total Power at 180° ± 30°(dB):	24	24	24	25
CPR at Boresight(dB):	15	15	15	15

Mechanical Data

Antenna Dimensions (mm):	1995×498×197
Packing Dimensions (mm):	2270×585×290
Antenna Net Weight /Bracket (kg):	36.5/5.9
Antenna Gross Weight (kg):	48.5
Radome Material:	Fiberglass
Pipe OD (mm):	50-115
Mounting Kits (Included):	BA.K.04.00069121, Adjustable Downtilt 0°-14°
Connector Type:	16×4.3-10 Female

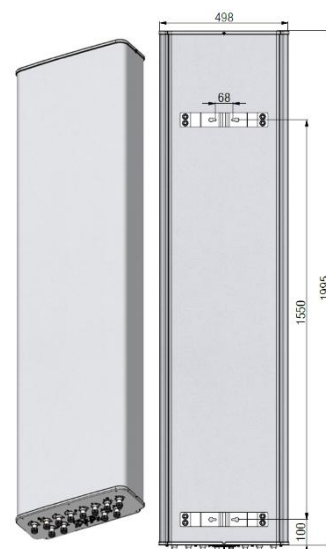

Environmental Ratings

Humidity:	95%RH@+30°C
Temperature (°C):	-40~+70
Wind Load @150 km/h (N):	Frontal/Lateral/Rearside: 1288/228/1307
Max. Wind velocity(km/h):	200

Internal RET Specifications

RET type:	Replaceable RET
RET protocol:	AISG2.0 /3GPP
Input voltage range(V):	10-30 DC
Power consumption(W):	< 5 (motor activated, single RET) < 1 (stand by, single RET), < 1.5 (stand by, 12V)
Adjustment time (full range) (s):	< 120 (typically, depending on antenna type)
RET connector:	1 pair of AISG 5 pin male & female
Pin assignment according AISG:	8 pin circular connector conforming to IEC 60130-9 - Ed. 3.0
Lightning protection (kA):	5 (8/20 μs Differential mode), 8 (8/20 μs Common mode)

Typical Patterns

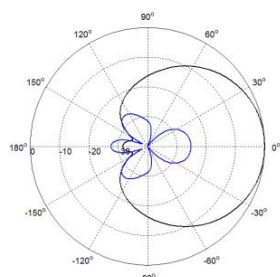

Azimuth(Low band)

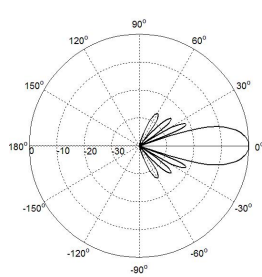

Elevation(Low band)

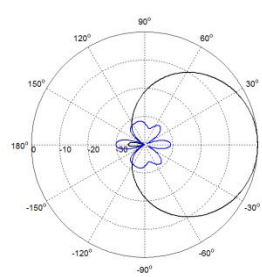

Azimuth(High band)

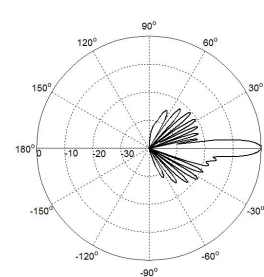

Elevation(High band)

U2L4PX308.10P-DH2-2C

Bottom View

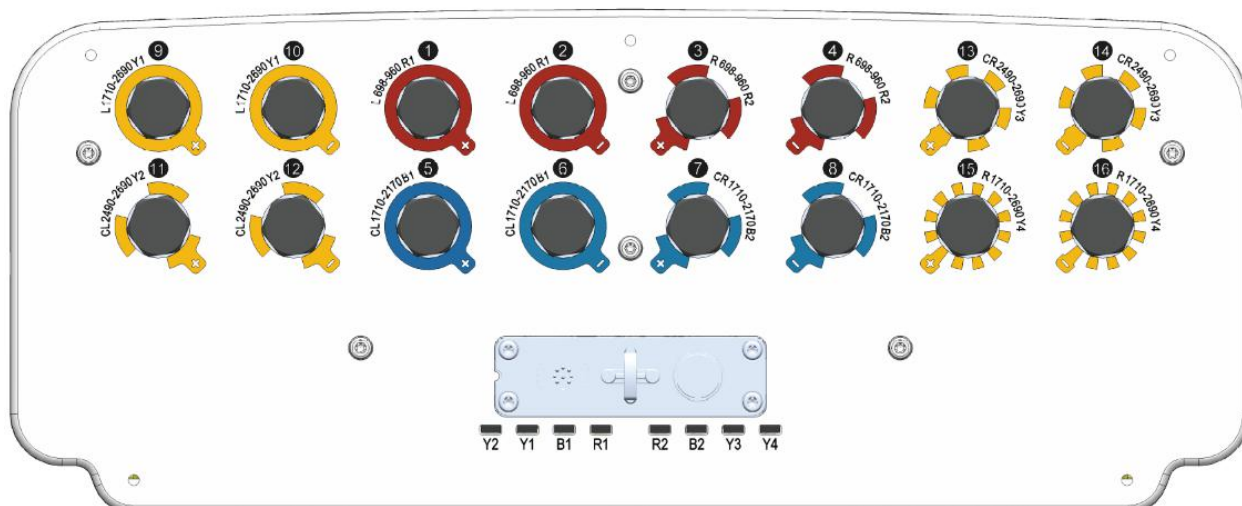

Correlation Table

Frequency range	Array	Connector	RET
698– 960 MHz	R1	1-2	BRxxx.....R1
698– 960 MHz	R2	3-4	BRxxx.....R2
1710–2170 MHz	B1	5-6	BRxxx.....B1
1710–2170 MHz	B2	7-8	BRxxx.....B2
1710–2690 MHz	Y1	9-10	BRxxx.....Y1
1710–2690 MHz	Y4	15-16	BRxxx.....Y4
2490–2690 MHz	Y2	11-12	BRxxx.....Y2
2490–2690 MHz	Y3	13-14	BRxxx.....Y3

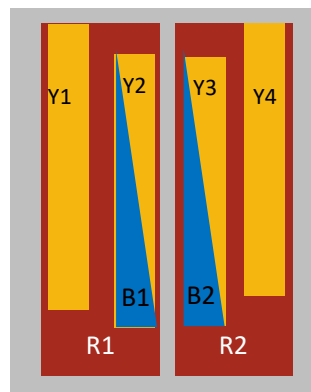

Product Data Sheet

U2L6PX310P-2C

XXXXXXXXX Pol Panel Antenna 2×698-960/6×1710-2690MHz 65°/65° 17/17.5dBi 2-12° Replaceable RET

Electrical Specifications

Frequency Range (MHz):	698-960(R1,R2)			1710-2690(Y1,Y3,Y5)			1710-2690(Y2,Y4,Y6)		
	698-806	806-880	880-960	1710	2300	2490	1710	2300	2490
Gain (dBi):	15.5 ±0.5	16.0 ±0.5	16.5 ±0.5	16.5 ±0.5	17.0 ±0.5	17.3 ±0.5	16.2 ±0.5	16.7 ±0.5	17.0 ±0.5
Return Loss (dB):	>14 (VSWR<1.5)								
Polarization:	±45°								
Horizontal 3dB Beamwidth (°):	68	65	57	68	65	58	68	65	58
Vertical 3dB Beamwidth (°):	10.0	8.7	7.8	7.2	5.7	5.2	7.2	5.7	5.2
Electrical Downtilt (°):	2-12 Independently Continuously Adjustable								
RET Type:	Cascade SRET, AISG 2.0, Upgradeable								
1 st Upper Sidelobe Suppression (dB):	15	15	15	15	15	15	15	15	15
Front to Back Ratio (dB):	22	23	24	25	25	25	25	25	25
Cross Polar Ratio 0°(dB):	15	15	15	15	15	15	15	15	15
Intraband Isolation (dB):	>25								
Interband Isolation (dB):	>25								
Power Rating (W):	250			200					
Intermodulation IM3 (dBc):	<-150(2×43 dBm)								
Impedance (ohm):	50								
Lightning Protection:	DC Grounded								
Connector Type:	16×4.3-10 Female								

Mechanical Data

Antenna Dimensions (mm):	2595×448×185
Packing Dimensions (mm):	2855×530×275
Antenna Net Weight /Bracket(kg):	46.5/5.9
Antenna Gross Weight (kg):	59.2
Radome Material:	Fiberglass
Pipe OD (mm):	50-115
Mounting Kits (Included):	BA.K.04.00069311, Adjustable Downtilt 0°-10°

Environmental Ratings

Humidity:	95%RH@+30°C
Temperature (°C):	-40~+70
Wind Load @150 km/h (N):	Frontal/Lateral/Rearside: 1135/289/1346
Max. Wind velocity(km/h):	200

Internal RET Specifications

RET Type:	Replaceable RET
RET protocol:	AISG 2.0 /3 GPP
Input voltage range(V):	10-30 DC
Power consumption(W):	< 5 (motor activated ,single RET) < 1 (stand by, single RET), < 1.5 (stand by, 12V)
Adjustment time (full range) (s):	< 120 (typically, depending on antenna type)
RET connector:	1 pair of AISG 5 pin male & female
Pin assignment according AISG:	8 pin circular connector conforming to IEC 60130-9 - Ed. 3.0
Lightning protection (kA):	5 (8/20 μs Differential mode), 8 (8/20 μs Common mode)

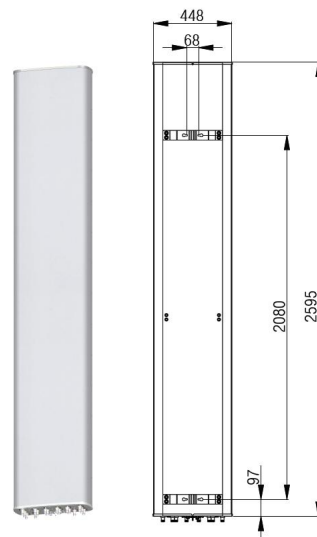

U2L6PX310P-2C

Typical Patterns

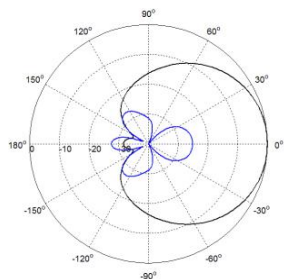

Azimuth(Low Band)

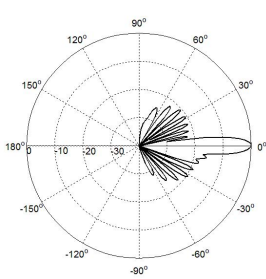

Elevation(Low Band)

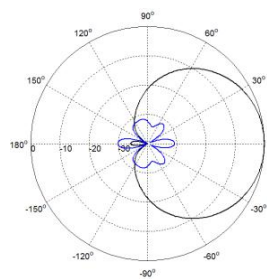

Azimuth(High Band)

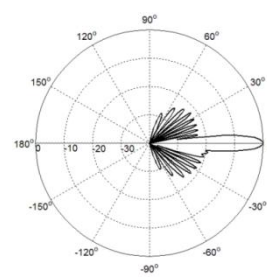

Elevation(High Band)

Bottom View

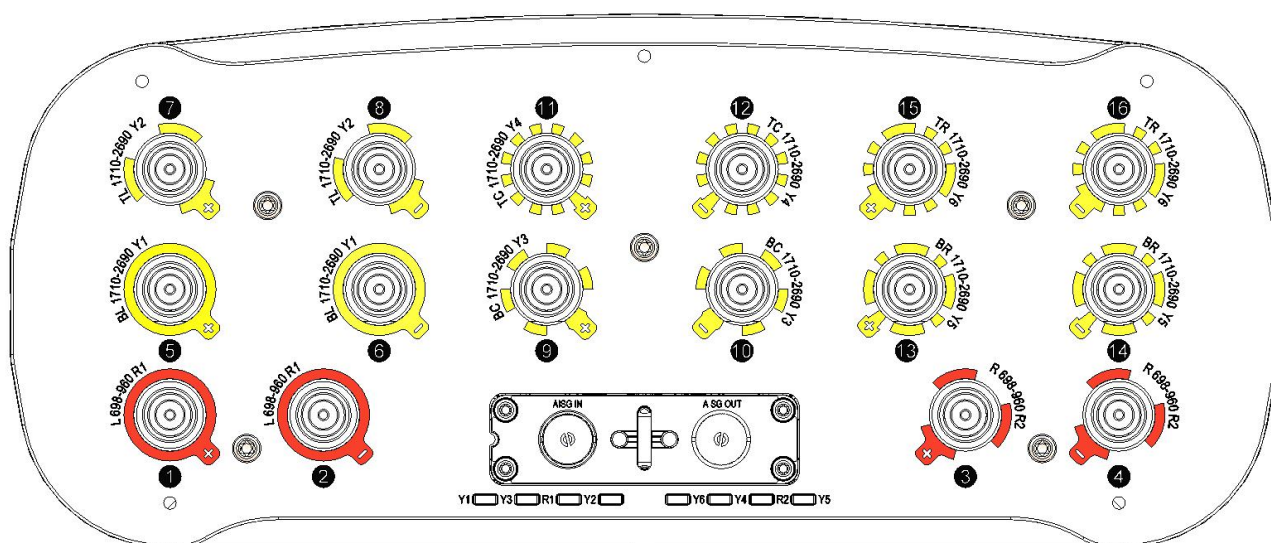

Correlation Table

Frequency range	Array	Connector
698–960 MHz	R1	1-2
698–960 MHz	R2	3-4
1710–2690 MHz	Y1	5-6
1710–2690 MHz	Y2	7-8
1710–2690 MHz	Y3	9-10
1710–2690 MHz	Y4	11-12
1710–2690 MHz	Y5	13-14
1710–2690 MHz	Y6	15-16

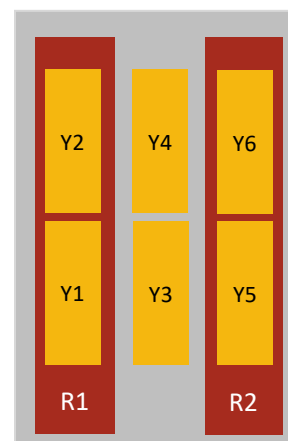

Product Data Sheet

U2CL4PX310P2-DL-E2-C

XXXXXXXXX Pol Panel Antenna 698-862/880-960/698-960/1427-2690/4×1710-2690MHz
65°/65°/65°/65°/65°15.5/16/16.5/16.5/17dBi 2°-12°Replaceable RET

Electrical Specifications

Frequency Range (MHz):	698-862(R1)	880-960(R2)	698-960(R3)		
			698-806	806-880	880-960
Gain (dBi):	15.2±0.5	15.8±0.5	15.3±0.5	15.8±0.5	16.3±0.5
Return Loss (dB):	>14 (VSWR<1.5)				
Polarization:	±45°				
Horizontal 3dB Beamwidth (°):	68	58	68	63	58
Vertical 3dB Beamwidth (°):	9.5	8.0	10.0	9.0	8.0
Electrical Downtilt (°):	2-12 Independently Continuously Adjustable				
RET Type:	Cascade SRET, AISG 2.0, Upgradeable				
1 st Upper Sidelobe Suppression (dB):	15	15	15	15	15
Front to Back Ratio@180±30° (dB):	22	24	22	23	24
Cross Polar Ratio 0°(dB):	15	15	15	15	15
Intraband Isolation (dB):	>25				
Interband Isolation (dB):	>25				
Max. Power Per Port (W)	250				
Intermodulation IM3 (dBc):	<-150(2×43 dBm)				
Impedance (ohm):	50				
Lightning Protection:	DC Grounded				

Frequency Range (MHz):		1427-2690(Y1)			4×1710-2690(Y2,Y3,Y4,Y5)		
		1427-1710	1710-2170	2300-2690	1710-2170	2300-2490	2490-2690
Gain (dBi):	Top(Y1\Y5)	14.6±0.5	15.8±0.5	16.3±0.5	15.8±0.5	16.2±0.5	16.5±0.5
	Bottom(Y2\Y3\Y4)	/	/	/	16.2±0.5	16.7±0.5	17.0±0.5
Return Loss (dB):	>14 (VSWR<1.5)						
Polarization:	±45°						
Horizontal 3dB Beamwidth (°):	74	65	58	68	65	60	
Vertical 3dB Beamwidth (°):	8.5	7.3	6.2	7.2	5.7	5.4	
Electrical Downtilt (°):	2-12 Independently Continuously Adjustable						
RET Type:	Cascade SRET, AISG 2.0, Upgradeable						
1 st Upper Sidelobe Suppression (dB):	15	15	15	15	15	15	
Front to Back Ratio@180±30° (dB):	25	25	25	25	25	25	
Cross Polar Ratio 0°(dB):	15	15	15	15	15	15	
Intraband Isolation (dB):	>25						
Interband Isolation (dB):	>25						
Max. Power Per Port (W)	200						
Intermodulation IM3 (dBc):	<-150(2×43 dBm)						
Impedance (ohm):	50						
Lightning Protection:	DC Grounded						



Product Data Sheet

U2CL4PX310P2-DL-E2-C

Mechanical Data

Antenna Dimensions (mm):	2595×448×185
Packing Dimensions (mm):	2825×535×295
Antenna Net Weight/Bracket (kg):	56/5.7
Antenna Gross Weight (kg):	68
Radome Material:	Fiberglass
Pipe OD (mm):	70-115
Mounting Kits (Included):	BA.K.04.00069471, Adjustable Downtilt 0°-8°(0°-8°in 1°steps)
Connector Type:	16×4.3-10 Female



Environmental Ratings

Humidity:	95%RH@+30°C
Temperature (°C):	-40~+70
Wind Load @150 km/h (N):	Frontal/Lateral/Rearside: 1135/289/1346
Max.Wind velocity(km/h):	200

Internal RET Specifications

RET type:	Replaceable RET
RET protocol:	AISG2.0 /3GPP
Input voltage range(V):	10-30 DC
Power consumption (W):	< 5 (motor activated , single RET) < 1 (stand by, single RET), < 1.5 (stand by, 12V)
Adjustment time (full range) (s):	< 120 (typically, depending on antenna type)
RET connector:	2 pair of AISG 5 pin male & female
Pin assignment according AISG:	5-pin circular connector conforming to IEC 60130-9 - Ed. 3.0
Lightning protection (kA):	5 (8/20 μs Differential mode), 8 (8/20 μs Common mode)

Typical Patterns

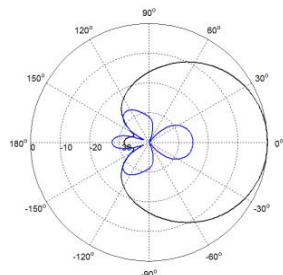

Azimuth(698-960MHz)

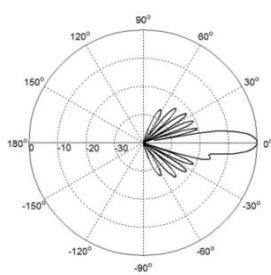

Elevation(698-960MHz)

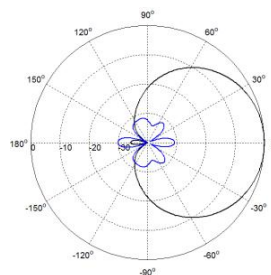

Azimuth(1710-2690MHz)

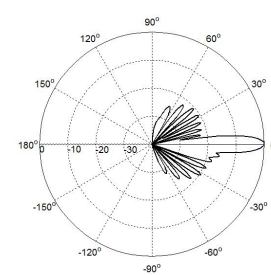

Elevation(1710-2690MHz)

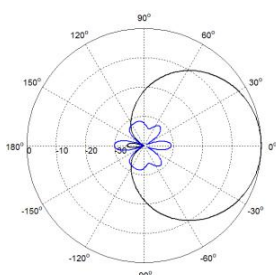

Azimuth(1427-2690MHz)

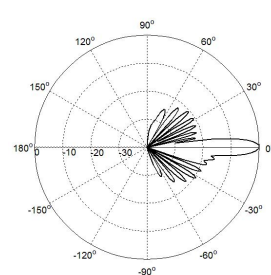

Elevation(1427-2690MHz)

Product Data Sheet

U2CL4PX310P2-DL-E2-C

Correlation Table

Frequency range	Array	Connector	RET S/N
698–862 MHz	R1	1-2	BRxxx.....1R1
880–960 MHz	R2	3-4	BRxxx.....2R2
698–960 MHz	R3	5-6	BRxxx.....3R3
1427–2690 MHz	Y1	7-8	BRxxx.....4Y1
1710–2690 MHz	Y2	9-10	BRxxx.....5Y2
1710–2690 MHz	Y3	11-12	BRxxx.....6Y3
1710–2690 MHz	Y4	13-14	BRxxx.....7Y4
1710–2690 MHz	Y5	15-16	BRxxx.....8Y5

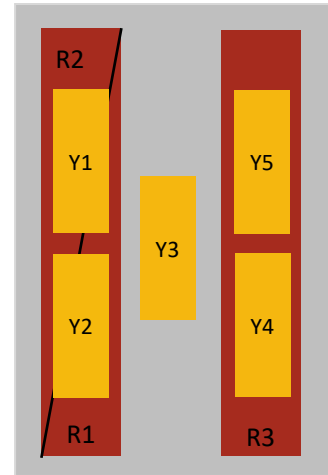

Bottom View

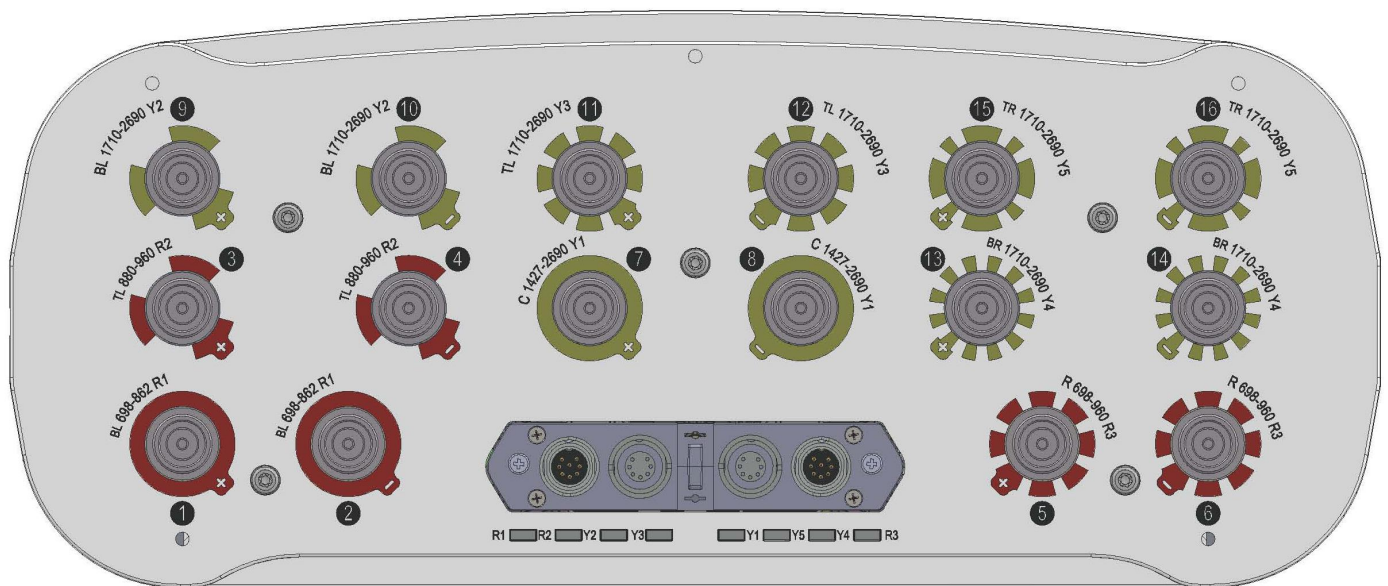

Product Data Sheet

U2L8PX310P-E2-C

XXXXXXXXXX Pol Panel Antenna 2×698-960/8×1710-2690MHz 65°/65° 16/17.5dBi 2°-12°

Replaceable RET

Electrical Specifications

Frequency Range (MHz):		698-960(R1,R2)		
		698-806	806-880	880-960
Gain (dBi):	Average Gain by all Beam Tilts(dBi):	15.2±1.0	15.5±0.9	15.3±0.8
	Average Gain by Beam Tilt (dB):	2° 152	2° 156	2° 155
		7° 153	7° 157	7° 155
	12° 151	12° 152	12° 150	
Return Loss (dB):		>14 (VSWR<1.5)		
Polarization:		±45°		
Horizontal 3dB Beamwidth (°):		68±7.2	61±8.5	62±9.0
Vertical 3dB Beamwidth (°):		9.5±0.9	8.5±0.7	7.8±0.7
Electrical Downtilt (°):		2-12 Independently Continuously Adjustable		
RET Type:		Cascade SRET, AISG 2.0, Upgradeable		
USLS(First lobe)(dB):		16	14	14
Front to back ratio, Total Power at 180° ± 30°(dB):		21	21	22
Cross Polar Ratio 0°(dB):		20	18	15
Cross Polar Ratio 60°(dB):		9	7	6
Intraband Isolation (dB):		>25		
Interband Isolation (dB):		>25		
Max. Power Per Port (W):		250		
Intermodulation IM3 (dBc):		<-150(2×43 dBm)		
Impedance (ohm):		50		
Lightning Protection:		DC Grounded		

Values based on NGMN-P-BASTA(version 10.0) requirements.

Frequency Range (MHz):		1710-2690(Y1,Y7)			
		1710-1920	1920-2170	2300-2490	2490-2690
Gain (dBi):	Average Gain by all Beam Tilts(dBi):	15.8±1.0	16.5±0.8	17.1±0.8	17.1±1.0
	Average Gain by Beam Tilt (dB):	2° 158	2° 167	2° 174	2° 176
		7° 157	7° 165	7° 171	7° 172
	12° 159	12° 164	12° 168	12° 166	
Return Loss (dB):		>14 (VSWR<1.5)			
Polarization:		±45°			
Horizontal 3dB Beamwidth (°):		69±9.5	67±6.5	61±4.0	62±5.8
Vertical 3dB Beamwidth (°):		8.0±1.0	7.3±0.9	6.5±0.9	6.1±0.7
Electrical Downtilt (°):		2-12 Independently Continuously Adjustable			
RET Type:		Cascade SRET, AISG 2.0, Upgradeable			
USLS(First lobe)(dB):		13	14	18	16
Front to back ratio, Total Power at 180° ± 30°(dB):		21	23	25	25
Cross Polar Ratio 0°(dB):		19	19	17	15
Cross Polar Ratio 60°(dB):		6	7	9	6
Intraband Isolation (dB):		>25			
Interband Isolation (dB):		>25			
Max. Power Per Port (W):		200			
Intermodulation IM3 (dBc):		<-150(2×43 dBm)			

Product Data Sheet

U2L8PX310P-E2-C

Impedance (ohm):	50
Lightning Protection:	DC Grounded

Values based on NGMN-P-BASTA(version 10.0) requirements.

Frequency Range (MHz):		1710-2690(Y2,Y8)			
		1710-1920	1920-2170	2300-2490	2490-2690
Gain (dBi):	Average Gain by all Beam Tilts(dBi):	15.5±0.8	16.3±0.9	16.9±0.7	16.7±1.0
	Average Gain by Beam Tilt (dB):	2° 155	2° 164	2° 172	2° 172
		7° 157	7° 162	7° 168	7° 168
	12° 154	12° 161	12° 165	12° 161	
Return Loss (dB):		>14 (VSWR<1.5)			
Polarization:		±45°			
Horizontal 3dB Beamwidth (°):		69±9.5	67±6.7	61±3.1	61±5.2
Vertical 3dB Beamwidth (°):		8.0±0.9	7.5±0.8	6.5±0.7	6.2±0.8
Electrical Downtilt (°):		2-12 Independently Continuously Adjustable			
RET Type:		Cascade SRET, AISG 2.0 ,Upgradeable			
USLS(First lobe)(dB):		13	16	17	15
Front to back ratio, Total Power at 180° ± 30°(dB):		22	25	27	26
Cross Polar Ratio 0°(dB):		20	20	16	15
Cross Polar Ratio 60°(dB):		6	7	9	5
Intraband Isolation (dB):		>25			
Interband Isolation (dB):		>25			
Max. Power Per Port (W):		200			
Intermodulation IM3 (dBC):		<-150(2×43 dBm)			
Impedance (ohm):		50			
Lightning Protection:		DC Grounded			

Values based on NGMN-P-BASTA(version 10.0) requirements.

Frequency Range (MHz):		1710-2690(Y3,Y5)			
		1710-1920	1920-2170	2300-2490	2490-2690
Gain (dBi):	Average Gain by all Beam Tilts(dBi):	15.8±0.9	16.6±0.8	16.7±0.8	16.7±0.9
	Average Gain by Beam Tilt (dB):	2° 158	2° 167	2° 171	2° 170
		7° 157	7° 166	7° 167	7° 169
	12° 159	12° 166	12° 164	12° 162	
Return Loss (dB):		>14 (VSWR<1.5)			
Polarization:		±45°			
Horizontal 3dB Beamwidth (°):		66±6.3	63±6.2	61±5.2	62±8.8
Vertical 3dB Beamwidth (°):		8.0±0.9	7.2±0.8	6.6±0.7	6.4±1.1
Electrical Downtilt (°):		2-12 Independently Continuously Adjustable			
RET Type:		Cascade SRET, AISG 2.0 ,Upgradeable			
USLS(First lobe)(dB):		13	16	15	14
Front to back ratio, Total Power at 180° ± 30°(dB):		23	26	26	25
Cross Polar Ratio 0°(dB):		13	15	16	13
Cross Polar Ratio 60°(dB):		6	6	4	4
Intraband Isolation (dB):		>25			
Interband Isolation (dB):		>25			
Max. Power Per Port (W):		200			
Intermodulation IM3 (dBC):		<-150(2×43 dBm)			



Product Data Sheet

U2L8PX310P-E2-C

Impedance (ohm):	50
Lightning Protection:	DC Grounded

Values based on NGMN-P-BASTA(version 10.0) requirements.

Frequency Range (MHz):		1710-2690(Y4,Y6)			
		1710-1920	1920-2170	2300-2490	2490-2690
Gain (dBi):	Average Gain by all Beam Tilts(dBi):	15.7±0.8	16.6±0.8	17.1±0.8	17.0±0.9
	Average Gain by Beam Tilt (dB):	2° 15.7	2° 16.8	2° 17.4	2° 17.4
		7° 15.7	7° 16.6	7° 17.1	7° 17.1
	12° 15.8	12° 16.4	12° 16.6	12° 16.4	
Return Loss (dB):		>14 (VSWR<1.5)			
Polarization:		±45°			
Horizontal 3dB Beamwidth (°):		65±6.2	63±5.7	60±5.0	59±5.1
Vertical 3dB Beamwidth (°):		8.1±0.8	7.5±0.8	6.4±0.6	6.1±0.7
Electrical Downtilt (°):		2-12 Independently Continuously Adjustable			
RET Type:		Cascade SRET, AISG 2.0 ,Upgradeable			
USLS(First lobe)(dB):		16	17	15	15
Front to back ratio, Total Power at 180° ± 30°(dB):		24	27	27	26
Cross Polar Ratio 0°(dB):		14	16	16	14
Cross Polar Ratio 60°(dB):		5	5	5	4
Intraband Isolation (dB):		>25			
Interband Isolation (dB):		>25			
Max. Power Per Port (W):		200			
Intermodulation IM3 (dBC):		<-150(2×43 dBm)			
Impedance (ohm):		50			
Lightning Protection:		DC Grounded			

Values based on NGMN-P-BASTA(version 10.0) requirements.

Mechanical Data

Antenna Dimensions (mm):	2675×498×197
Packing Dimensions (mm):	2865x605x370
Antenna Net Weight /Bracket(kg):	62.5/6.3
Antenna Gross Weight (kg):	76
Connector Type:	20×4.3-10 Female
Radome Material:	Fiberglass
Pipe OD (mm):	70-114
Mounting Kits (Included):	BA.K.04.00002, Adjustable Downtilt 0°-8°

Environmental Ratings

Humidity:	95%RH@+30°C
Temperature (°C):	-40~+70
Wind Load @150 km/h (N):	Frontal/Lateral/Rearside:2365/500/2494
Max. Wind velocity(km/h):	200

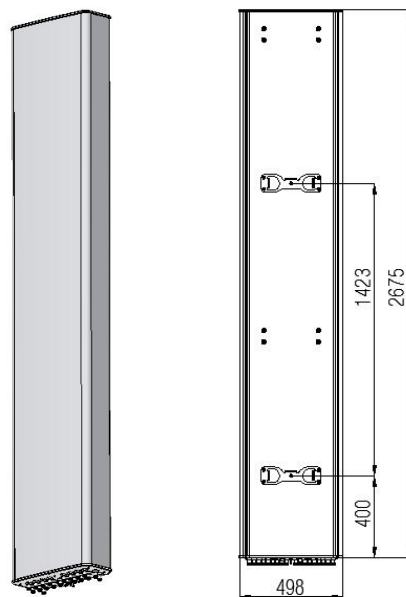

U2L8PX310P-E2-C

Internal RET Specifications

RET type:	Replaceable RET
RET protocol:	AISG 2.0 /3 GPP
Input voltage range(V):	10-30 DC
Power consumption(W):	< 5 (motor activated , single RET) < 1 (stand by, single RET), < 1.5 (stand by, 12V)
Adjustment time (full range): (s):	< 120 (typically, depending on antenna type)
RET connector:	1 pair of AISG 5 pin male & female
Pin assignment according AISG:	8 pin circular connector conforming to IEC 60130-9 - Ed. 3.0
Lightning protection (kA):	5 (8/20 μs Differential mode), 8 (8/20 μs Common mode)

Typical Patterns

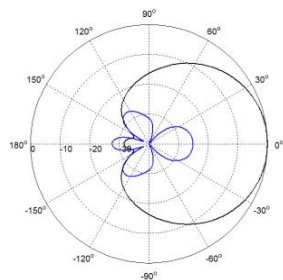

Azimuth(Low Band)

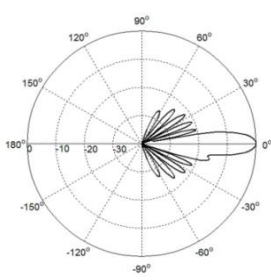

Elevation(Low Band)

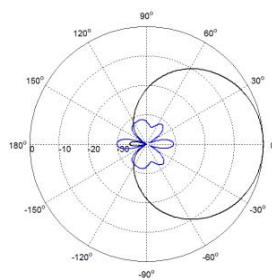

Azimuth(High Band)

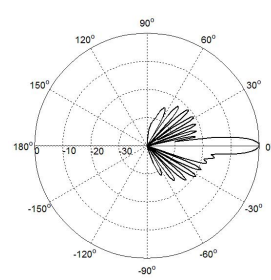

Elevation(High Band)

Bottom View

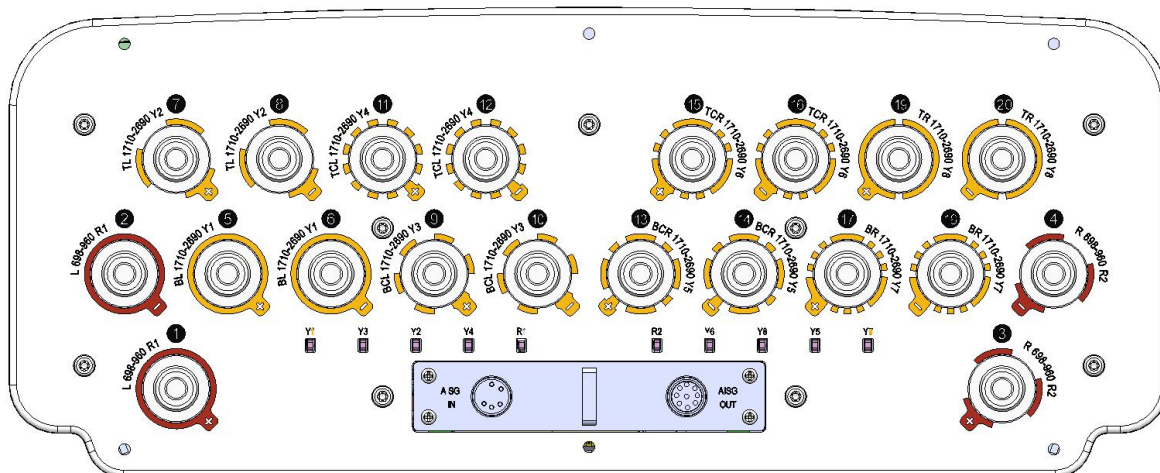

Correlation Table

Frequency range	Array	Connector
698– 960 MHz	R1	1-2
698– 960 MHz	R2	3-4
1710–2690 MHz	Y1	5-6
1710–2690 MHz	Y2	7-8
1710–2690 MHz	Y3	9-10
1710–2690 MHz	Y4	11-12
1710–2690 MHz	Y5	13-14
1710–2690 MHz	Y6	15-16
1710–2690 MHz	Y7	17-18
1710–2690 MHz	Y8	19-20

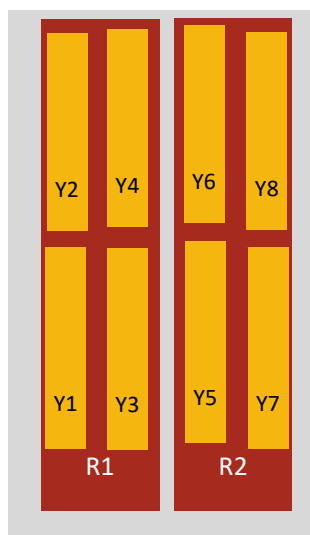

Product Data Sheet

U2C2L6PX310P2-DLL-2C

XXXXXXXXXXXX Pol Panel Antenna 2×698-862/2×880-960/2×1427-2690/6×1710-2690MHz
65°/65°/65°/65° 14.5/15/17/17.5dBi 2°-12° Replaceable RET

Electrical Specifications

Frequency Range (MHz):	698-960(R1,R2,R3,R4)	
	698-862(R1,R2)	880-960(R3,R4)
Gain (dBi):	14.3±0.5	15.0±0.5
Return Loss (dB):	>14 (VSWR<1.5)	
Polarization:	±45°	
Horizontal 3dB Beamwidth (°):	70	58
Vertical 3dB Beamwidth (°):	9.5	8.0
Electrical Downtilt (°):	2-12 Independently Continuously Adjustable	
RET Type:	Cascade SRET, AISG 2.0 ,Upgradeable	
1 st Upper Sidelobe Suppression (dB):	15	15
Front to Back Ratio@180±30° (dB):	21	22
Cross Polar Ratio 0°(dB):	15	15
Intraband Isolation (dB):	>25	
Interband Isolation (dB):	>25	
Max. Power Per Port (W)	250	
Intermodulation IM3 (dBc):	<-150(2×43 dBm)	
Impedance (ohm):	50	
Lightning Protection:	DC Grounded	

Frequency Range (MHz):		2x1427-2690(Y2,Y8)			6x1710-2690(Y1,Y3,Y4,Y5,Y6,Y7)		
		1427-1518	1710-2170	2300-2690	1710-2170	2300-2490	2490-2690
Gain (dBi):	Bottom	/	/	/	16.3±0.5	17.3±0.5	17.2±0.5
	Top	15.5±0.5	16.1±0.5	17.0±0.5	16.1±0.5	17.0±0.5	16.8±0.5
Return Loss (dB):		>14 (VSWR<1.5)					
Polarization:		±45°					
Horizontal 3dB Beamwidth (°):		73	65	58	70	65	58
Vertical 3dB Beamwidth (°):		8.7	7.0	5.5	7.2	5.8	5.5
Electrical Downtilt (°):		2-12 Independently Continuously Adjustable (Y1 and Y3 Controlled by the Same Motor) (Y2 and Y4 Controlled by the Same Motor)					
RET Type:		Cascade SRET, AISG 2.0 ,Upgradeable					
1 st Upper Sidelobe Suppression (dB):		15	15	15	15	15	15
Front to Back Ratio@180±30° (dB):		23	24	25	24	25	25
Cross Polar Ratio 0°(dB):		15	15	15	15	15	15
Intraband Isolation (dB):		>25					
Interband Isolation (dB):		>25					
Max. Power Per Port (W)		200					
Intermodulation IM3 (dBc):		<-150(2×43 dBm)					
Impedance (ohm):		50					
Lightning Protection:		DC Grounded					

Product Data Sheet

U2C2L6PX310P2-DLL-2C

Mechanical Data

Antenna Dimensions (mm):	2695×498×197
Packing Dimensions (mm):	2925×585×290
Antenna Net Weight /Bracket(kg):	60.5/5.7
Antenna Gross Weight (kg):	73.5
Radome Material:	Fiberglass
Pipe OD (mm):	70-114
Mounting Kits (Included):	BA.K.04.00069871, Adjustable Downtilt 0°-8° (0°-8°in 1°steps)
Connector Type:	24×4.3-10 Female



Environmental Ratings

Humidity:	95%RH@+30°C
Temperature (°C):	-40~+70
Wind Load @150 km/h (N):	Frontal/Lateral/Rearside:1763 / 324 / 1788
Max. Wind velocity (km/h):	200

Internal RET Specifications

RET type:	Replaceable RET
RET protocol:	AISG2.0 /3GPP
Input voltage range(V):	10-30 DC
Power consumption(W):	< 5 (motor activated , single RET) < 1 (stand by, single RET), < 1.5 (stand by, 12V)
Adjustment time (full range): (s):	< 120 (typically, depending on antenna type)
RET connector:	2 pair of AISG 5 pin male & female
Pin assignment according AISG:	8 pin circular connector conforming to IEC 60130-9 - Ed. 3.0
Lightning protection (kA):	5 (8/20 μsDifferential mode), 8 (8/20 μsCommon mode)

Typical Patterns

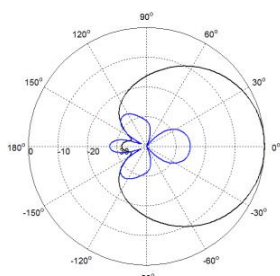

Azimuth(698-960MHz)

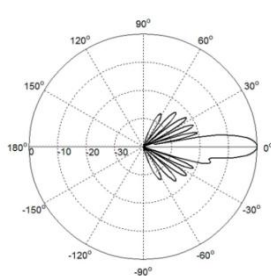

Elevation(698-960MHz)

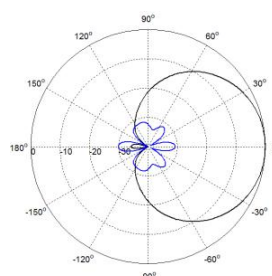

Azimuth(1710-2690MHz)

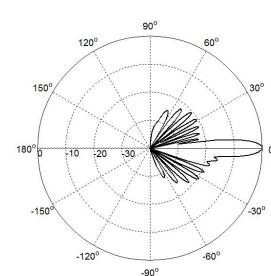

Elevation(1710-2690MHz)

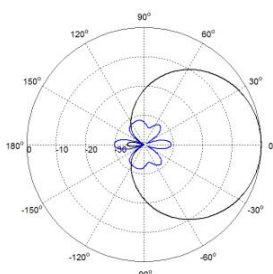

Azimuth(1427-2690MHz)

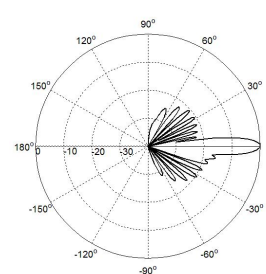

Elevation(1427-2690MHz)



Product Data Sheet

U2C2L6PX310P2-DLL-2C

Bottom View

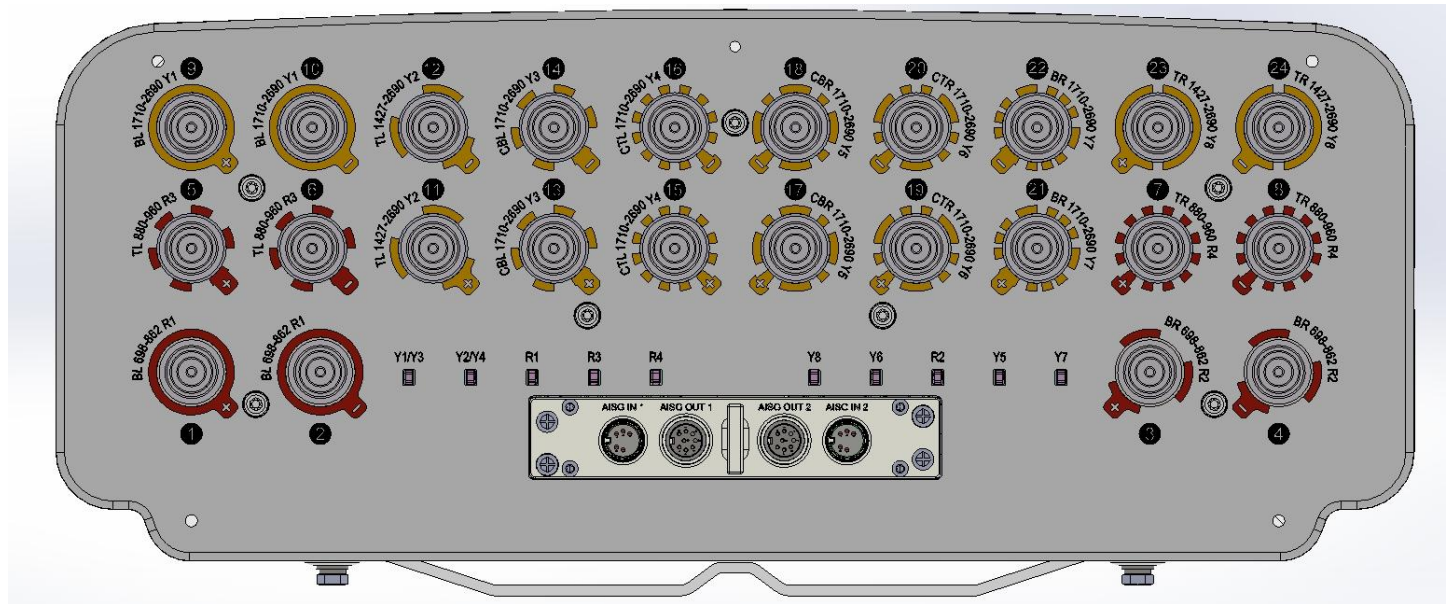

Correlation Table

Frequency range	Array	Connector	RET
698–862 MHz	R1	1-2	BR...1R1
698–862 MHz	R2	3-4	BR...2R2
880–960 MHz	R3	5-6	BR...3R3
880–960 MHz	R4	7-8	BR...4R4
1710–2690 MHz	Y1	9-10	BR...5Y1
1710–2690 MHz	Y3	13-14	
1427–2690 MHz	Y2	11-12	
1710–2690 MHz	Y4	15-16	BR...6Y2
1710–2690 MHz	Y5	17-18	BR...7Y5
1710–2690 MHz	Y6	19-20	BR...8Y6
1710–2690 MHz	Y7	21-22	BR...9Y7
1427–2690 MHz	Y8	23-24	BR...AY8

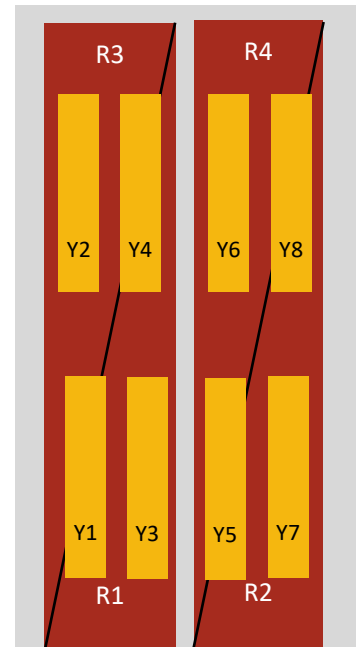

TDD Antennas

No.	BR Part No.	Frequency(MHz)	HBW(deg)	Gain(dBi)	E-Tilt	Size mm(L*W*D)	Page
1	★S-VPX0410P-V1-2C	3300-3800	80	14.5	2-12° RET	900×300×150	180
2	S-VUL4PX2.2.2F3-C	3300-3800/698-960/4×1695-2690	80/65/65	10/10/11	3° FET	395×396×190	182
3	S-VUL4PX7.3.3PF3-E2-C	3300-3800/698-960/4×1695-2690	80/65/65	13.5/12/12.5	2-12° RET /3°FET/3° FET	895×396×190	186
4	S-VUL4PX10.5.5P-E2-C	3300-3800/698-960/4×1695-2690	80/65/65	15/14/14	2-12° RET	1390×396×190	191
5	S-VU2L4PX7.3.3PF3-2C	3300-3800/2×698-960/4×1710-2690	65/65/65	13.5/12/13	2-12° RET /3°FET/3° FET	895×498×197	195
6	★S-VU2L4PX8.4.4P-2C	3300-3800/2×698-960/4×1710-2690	65/65/65	14/12/14	2-12° RET	1095×498×197	201
7	S-VU2L4PX10.5.5P-2C	3300-3800/2×698-960/4×1710-2690	65/65/65	15/14/14.5	2-12° RET	1395×498×197	204
8	S-HPX0410P-E2-C	2300-2690	65	17	2-12° RET	1500×370×124	209
9	S-HU2PX10.6P-E2-C	2300-2690/2×690-960	90/65	15/14	2-12° RET	2095×448×145	212

10	S-HU2L2PX308.9P-DH2-2C	2300-2690/2×698-960/2×1710-2170/ 2×2500-2690	65/65/65/65	14.5/15/16.5/17	2-12° RET	2095×448×200	216
11	★S-HU2L4PX10.10.12P-E2-C	2300-2690/2×698-960/4×1710-2690	90/65/65	15.5/16/18	2-12° RET	2695×498×197	220

★ denotes the preliminary issued antenna

Product Data Sheet

S-VPX0410P-V1-2C**X Pol Panel TD Antenna 3300-3800MHz 80°14.5dBi 2-12° Replaceable RET****Electrical Specifications (3300-3800MHz)**

Electrical Specifications (3300-3800MHz)			
General parameters	Frequency range (MHz):		3300-3800(P1)
	Polarization:		±45°
	Electrical downtilt (°):		2-12, continuously adjustable
	Lightning Protection:		DC Grounded
	Connector Type:		9x4.3-10 Female
Calibration and electrical parameters	Coupling factor between calibration port and each antenna port (dB) :		-26±2
	Max Amp/phase Deviation:		<1.0/ 12°
	VSWR:		<1.5
	Max. Power Per Port (W):		80
	Co-polarization isolation between ports (dB):		>20
		Cross-polarization isolation between ports (dB) :	>25
Radiation parameters	Single Column	Horizontal 3dB Beamwidth (°):	80±10
		Vertical 3dB Beamwidth (°):	7
		Front to Back Ratio (dB):	23
		Gain (dBi):	14.5±0.5
		Cross polar ratio (dB):	>15 (0°)/>8 (±60°)
	Broadcast Beam	Horizontal 3dB Beamwidth (°):	65±10
		Gain (dBi):	16.0±0.5
		Front to Back Ratio (dB):	25
		Vertical 3dB Beamwidth (°):	7
		Cross polar ratio (dB):	>15 (0°)/>8 (±60°)
	Service Beam @ 0deg	1st Upper Sidelobe Suppression (dB):	>14
		Gain (dBi):	19.5±0.5
		Horizontal 3dB Beamwidth (°):	19
		Horizontal Sidelobe Level (dB):	<-12
		Cross polar ratio (0°) (dB):	15
	Service Beam@ 60deg	Front to Back Ratio (dB):	25
Gain (dBi):		16.0±0.5	
Horizontal 3dB Beamwidth (°):		20	
		Horizontal Sidelobe Level (dB):	<-3



Product Data Sheet

S-VPX0410P-V1-2C

Mechanical Data

Antenna Dimensions (mm):	900×300×115
Packing Dimensions (mm):	1170×385×210
Antenna Net Weight/Bracket (kg):	11/5.9
Antenna Gross Weight (kg):	20
Radome Material:	Fiberglass
Pipe OD (mm):	50-115
Mounting Kits (Included):	BA.K.04.00069161, Adjustable Downtilt 0-30°



Environmental Ratings

Humidity:	95%RH@+30°C
Temperature (°C):	-40~+70
Wind Load @150 km/h (N):	Frontal/ Lateral/ Rearside:214/57/400
Max. Wind Velocity(km/h) :	200

Internal RET Specifications

RET type:	Replaceable RET
RET protocol:	AISG2.0 /3GPP
Input voltage range(V):	10-30 DC
Power consumption(W):	< 5 (motor activated , single RET) < 1 (stand by, single RET), < 1.5 (stand by, 12V)
Adjustment time (full range) (s):	< 120 (typically, depending on antenna type)
RET connector:	1 pair of AISG 5 pin male & female
Pin assignment according AISG:	8-pin circular connector conforming to IEC 60130-9 - Ed. 3.0
Lightning protection(kA):	5 (8/20 μs Differential mode), 8 (8/20 μs Common mode)

Typical Patterns

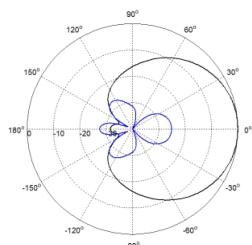

Single Column

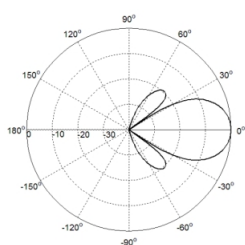

Service Beam @0deg

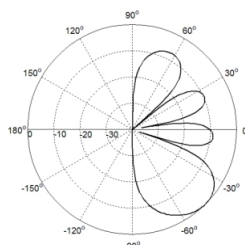

Service Beam @60deg

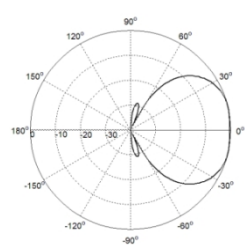

Broadcast Beam

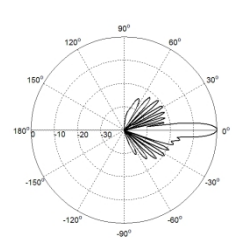

Elevation

Correlation Table

Frequency Range	Array	Connector
3300-3800MHz	P1	9x4.3-10 Female

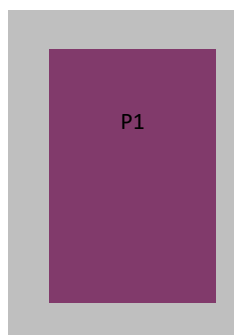

Product Data Sheet

S-VUL4PX2.2.2F3-C

X Pol Panel TD Antenna 3300-3800MHz 80°10dBi 3° FET

XXXXX Pol 698-960/4×1695-2690MHz 65°/65°10/11dBi 3° FET

Electrical Specifications (3300-3800MHz)

Electrical Specifications (3300-3800MHz)			
General parameters	Frequency range (MHz):		3300-3800(P1)
	Polarization:		±45°
	Electrical downtilt (°):		3 Fixed
	Connector Type:		1xMQ5,1xMQ4
Calibration and electrical parameters	Coupling factor between calibration port and each antenna port (dB) :		-26±2
	Amp/phase Deviation:		<1.2/12°
	VSWR:		<1.5
	Max. Power Per Port (W):		40
	Co-polarization isolation between ports (dB):		>20
	Cross-polarization isolation between ports (dB) :		>19
Radiation parameters	Single Column	Horizontal 3dB Beamwidth (°):	80±10
		Vertical 3dB Beamwidth (°):	31
		Front to Back Ratio (dB):	23
		Gain (dBi):	9.5±0.5
		Cross polar ratio (dB):	>15 (0°)/>8 (±60°)
	Broadcast Beam	Horizontal 3dB Beamwidth (°):	65±10
		Gain (dBi):	11.0±0.5
		Front to Back Ratio (dB):	25
		Vertical 3dB Beamwidth (°):	31
		Cross polar ratio (dB):	>15 (0°)/>8 (±60°)
	Service Beam @ 0deg	Gain (dBi):	14.5±0.5
		Horizontal 3dB Beamwidth (°):	19
		Horizontal Sidelobe Level (dB):	<-12
		Cross polar ratio (0°) (dB):	15
		Front to Back Ratio (dB):	25
	Service Beam@ 60deg	Gain (dBi):	11.0±0.5
Horizontal 3dB Beamwidth (°):		20	
Horizontal Sidelobe Level (dB):		<-3	

Product Data Sheet

S-VUL4PX2.2.2F3-C

Electrical Specifications (698-960/1695-2690 MHz)

Frequency Range (MHz):	698-960(R1)			1695-2690(Y1,Y2,Y3,Y4)		
	698-806	806-880	880-960	1695-2170	2300-2490	2490-2690
Gain (dBi):	8.8±0.5	9.2±0.5	9.6±0.5	10.0±0.5	10.6±0.5	11.0±0.5
Return Loss (dB):	>14 (VSWR<1.5)					
Polarization:	±45°					
Horizontal 3dB beamwidth (°):	68	65	62	68	65	60
Vertical 3dB beamwidth (°):	44	42	39	36	33	31
Electrical Downtilt (°):	3 Fixed			3 Fixed		
Front to Back Ratio @180±30°(dB):	21	22	23	25	25	25
Cross Polar Ratio 0° (dB):	15	15	15	15	15	15
polarization Isolation (dB):	>20					
Interband Isolation (dB):	>20					
Max. Power Per Port (W):	150			100		
Intermodulation IM3 (dBC):	<-150 (2×43dBm)					
Impedance (ohm):	50					
Lightning Protection:	DC Grounded					
Connector Type:	10x4.3-10 Female					

BASTA Electrical Specifications

Frequency Range(MHz):	698-960(R1)			4×1695-2690(Y1,Y2,Y3,Y4)			3300-3800(P1)
	698-806	806-880	880-960	1695-2170	2300-2490	2490-2690	
Average Gain by all Beam Tilts (dBi):	8.64	8.92	9.15	10.40	10.83	11.03	9.85
Gain by all Beam Tilts Tolerance(dB):	±0.52	±0.56	±0.41	±0.55	±0.50	±0.68	±0.71
Horizontal Beamwidth Tolerance(°):	±4.45	±6.82	±6.25	±6.65	±6.38	±6.84	±10.26
Vertical Beamwidth Tolerance(°):	±3.34	±3.25	±3.67	±3.32	±3.03	±3.85	±4.18
Front to back Total Power at 180° ± 30°(dB):	21.25	22.57	23.12	25.76	26.27	25.73	23.60
CPR at Boresight(dB):	21.21	19.26	20.86	21.91	22.32	21.61	20.99

Mechanical Data

Antenna Dimensions (mm):	395×396×190
Packing Dimensions (mm):	650x465x305
Antenna Net Weight/Bracket (kg):	6.8/2.6
Antenna Gross Weight (kg):	10.5
Radome Material:	Fiberglass
Pipe OD (mm):	70-110
Mounting Kits (Included):	BA.K.04.00052, horizontal adjustable -35°-+35°, vertical adjustable -45°-+45°

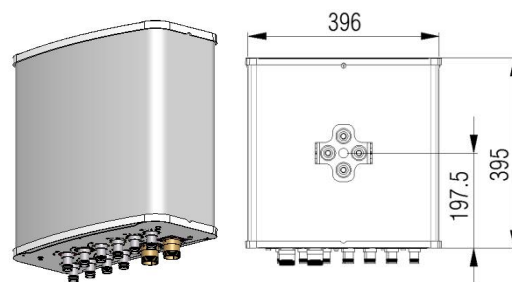

Environmental Ratings

Humidity:	95%RH@+30°C
Temperature (°C):	-50~+60
Wind Load @150 km/h (N):	Frontal/Lateral/Rearside:197/57/260
Max. Wind velocity(km/h) :	200

S-VUL4PX2.2.2F3-C

Typical Patterns

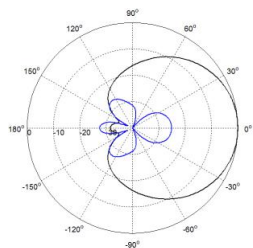

Single Column

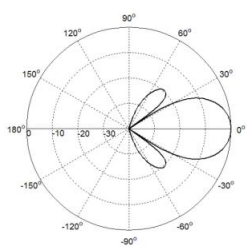

Service Beam @0deg

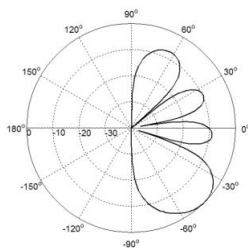

Service Beam @60deg

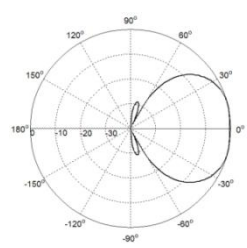

Broadcast Beam

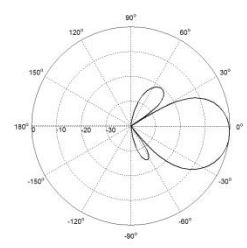

Elevation

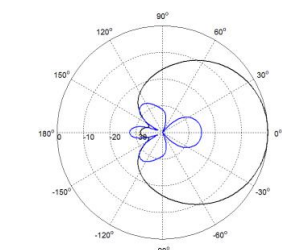

Azimuth(698-960MHz)

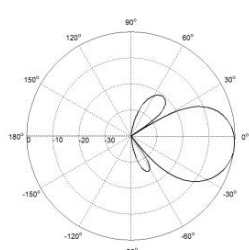

Elevation(698-960MHz)

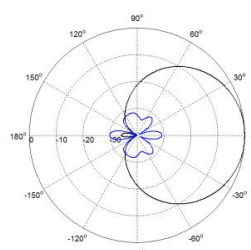

Azimuth(1695-2690MHz)

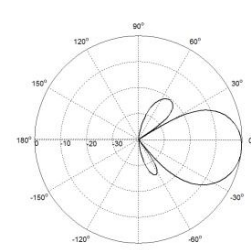

Elevation(1695-2690MHz)

Correlation Table

Frequency Range	Array	Connector
698-960 MHz	R1	1-2
1695-2690 MHz	Y1	3-4
1695-2690 MHz	Y2	5-6
1695-2690 MHz	Y3	7-8
1695-2690 MHz	Y4	9-10
3300-3800 MHz	P1	1xMQ5, 1xMQ4

MQ4/MQ5 Port Mapping

Connector	Pin	Frequency	Polarization/Port
MQ5	1	3300-3800 MHz	+45
	2	3300-3800 MHz	+45
	3	3300-3800 MHz	+45
	4	3300-3800 MHz	+45
	5	3300-3800 MHz	Calibration port
MQ4	1	3300-3800 MHz	-45
	2	3300-3800 MHz	-45
	3	3300-3800 MHz	-45
	4	3300-3800 MHz	-45

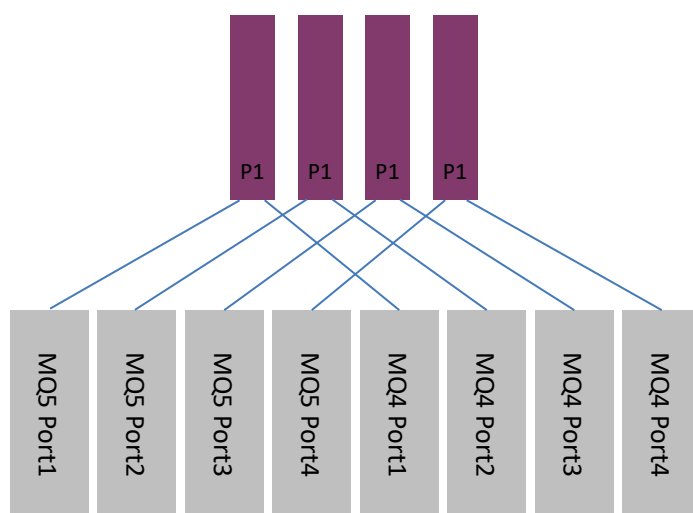
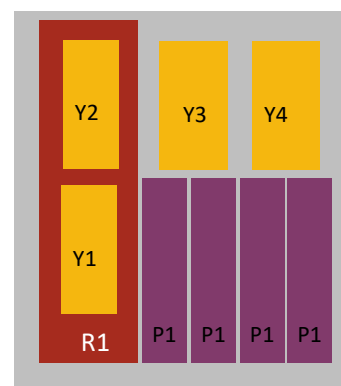

S-VUL4PX2.2.2F3-C

Bottom View

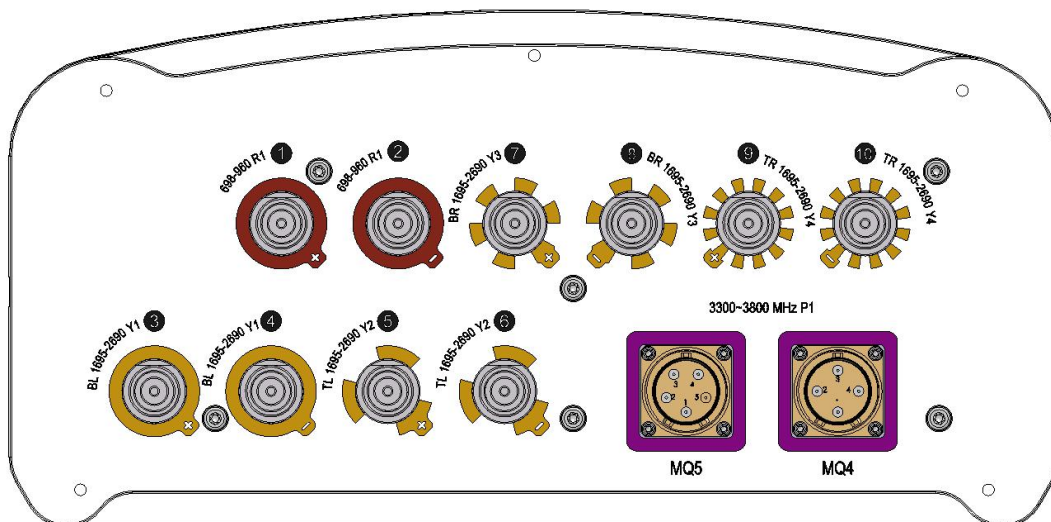

Broadcast Beam Weight Value for Reference

/	/	P1/P5	P2/P6	P3/P7	P4/P8
3C(3300-3800MHz)	Amp[li]	1	1	0.65	0.25
	Phase	0	0	180	0

S-VUL4PX7.3.3PF3-E2-C

X Pol Panel TD Antenna 3300-3800MHz 80° 13.5dBi 2°-12° Replaceable RET

XXXXX Pol 698-960/4×1695-2690MHz 65°/65° 12/12.5dBi 3°/3° FET

Electrical Specifications

Electrical Specifications (3300-3800MHz)			
General parameters	Frequency range (MHz):	3300-3800(P1)	
	Polarization:	±45°	
	Electrical downtilt (°):	2-12 , continuously adjustable	
	Connector Type:	1xMQ5,1xMQ4	
Calibration and electrical parameters	Coupling factor between calibration port and each antenna port (dB) :	-26±2	
	Max Amp/phase Deviation:	<1.2/ 12°	
	VSWR:	<1.5	
	Max. Power Per Port (W):	40	
	Interband Isolation (dB):	>20	
Radiation parameters	Single Column	Horizontal 3dB Beamwidth (°):	80±10
		Vertical 3dB Beamwidth (°):	9.5
		Front to Back Ratio (dB):	23
		Gain (dBi):	13.5±0.5
		Cross polar ratio (dB):	>15 (0°)/>8 (±60°)
	Broadcast Beam	Horizontal 3dB Beamwidth (°):	65±10
		Gain (dBi):	15.0±0.5
		Front to Back Ratio (dB):	25
		Vertical 3dB Beamwidth (°):	9.5
		Cross polar ratio (dB):	>15 (0°)/>8 (±60°)
	Service Beam @ 0deg	1 st Upper Sidelobe Suppression (dB):	>14
		Gain (dBi):	17.0±0.5
		Horizontal 3dB Beamwidth (°):	19
		Horizontal Sidelobe Level (dB):	<-12
		Cross polar ratio (0°) (dB):	15
	Service Beam@ 60deg	Front to Back Ratio (dB):	25
Gain (dBi):		14.5±0.5	
Horizontal 3dB Beamwidth (°):		20	
	Horizontal Sidelobe Level (dB):	<-3	

Product Data Sheet

S-VUL4PX7.3.3PF3-E2-C

Electrical Specifications (698-960/1695-2690 MHz)

Frequency Range (MHz):	698-960(R1)			1695-2690(Y1,Y2,Y3,Y4)		
	698-806	806-880	880-960	1695-2170	2300-2490	2490-2690
Gain (dBi):	11.0±0.6	11.0±0.5	11.3±0.8	11.3±0.6	12.5±0.5	13.0±0.5
Return Loss (dB):	>14 (VSWR<1.5)					
Polarization:	±45°					
Horizontal 3dB beamwidth (°):	68	65	60	72	69	67
Vertical 3dB beamwidth (°):	28	26	24	24	21	19
Electrical Downtilt (°):	3 Fixed					
Polarization Isolation (dB):	>23					
Interband Isolation (dB):	>23					
Max. Power Per Port (W):	250			200		
Intermodulation IM3 (dBc):	<-150 (2×43dBm)					
Impedance (ohm):	50					
Lightning Protection:	DC Grounded					
Connector Type:	10x4.3-10 Female					

BASTA Electrical Specifications

Frequency Range(MHz):	698-960(R1)			4×1695-2690(Y1,Y2,Y3,Y4)			3300-3800(P1)
	698-806	806-880	880-960	1695-2170	2300-2490	2490-2690	
Average Gain by all Beam Tilts (dBi):	10.5	10.7	10.6	11.0	12.5	13.0	13.0
Gain by all Beam Tilts Tolerance(dB):	±0.7	±0.6	±0.6	±1.0	±0.7	±0.8	±0.9
Average Gain by Beam Tilt (dBi):	3° 10.5	3° 10.7	3° 10.6	3° 11.0	3° 12.5	3° 13.0	2° 13.4 7° 13.3 12° 12.4
Horizontal Beamwidth Tolerance(°):	±3.0	±3.5	±3.0	±12.2	±10.7	±9.8	±16.4
Vertical Beamwidth Tolerance(°):	±1.9	±1.9	±2.7	±3.4	±1.9	±1.6	±1.5
1 st Upper Sidelobe Suppression (dB) :	15.0	11.1	11.4	11.2	11.9	11.2	12.4
Front to back	23.1	23.3	25.0	23.2	26.5	24.9	23.7
Total Power at 180° ± 30°(dB):	23.1	23.3	25.0	23.2	26.5	24.9	23.7
CPR at Boresight(dB):	15.2	15.6	15.6	17.6	17.7	17.8	14.3

Mechanical Data

Antenna Dimensions (mm):	895×396×190
Packing Dimensions (mm):	1165x465x265
Antenna Net Weight/Bracket (kg): (kg):	16/5.9
Antenna Gross Weight (kg):	24.5
Radome Material:	Fiberglass
Pipe OD (mm):	50-114
Mounting Kits (Included):	BA.K.04.00069161, Adjustable Downtilt 0°-14°

Environmental Ratings

Humidity:	95%RH@+30°C
Temperature (°C):	-40~+70
Wind Load @150 km/h (N):	Frontal/Lateral/Rearside:732/218/966
Max. Wind velocity(km/h):	200

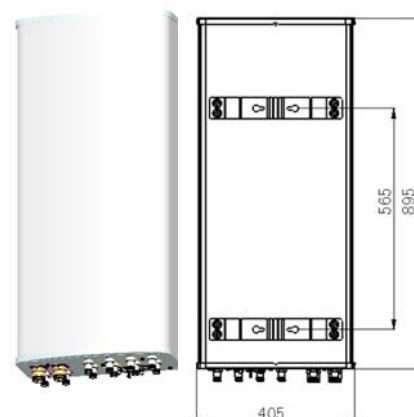

S-VUL4PX7.3.3PF3-E2-C

Internal RET Specifications

RET type:	Replaceable RET
RET protocol:	AISG 2.0 /3 GPP
Input voltage range(V):	10-30 DC
Power consumption (W):	< 5 (motor activated, single RET) < 1 (stand by, single RET), < 1.5 (stand by, 12V)
Adjustment time (full range) (s):	< 120 (typically, depending on antenna type)
RET connector:	one pair of AISG 5 pin male & female
Pin assignment according AISG:	8 pin circular connector conforming to IEC 60130-9 - Ed. 3.0
Lightning protection (kA):	5 (8/20 μs Differential mode), 8 (8/20 μs Common mode)

Typical Patterns

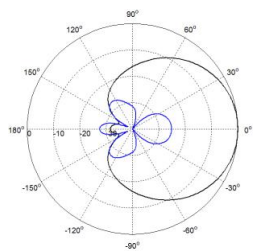

Single Column

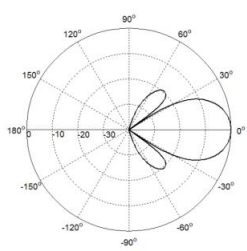

Service Beam @0deg

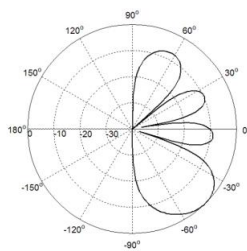

Service Beam @60deg

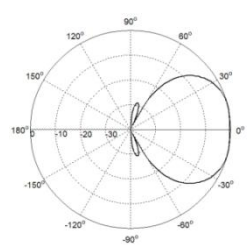

Broadcast Beam

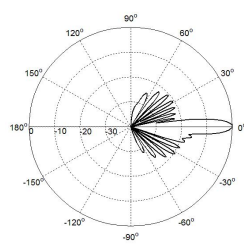

Elevation

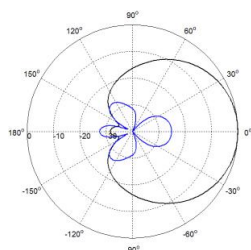

Azimuth(698-960MHz)

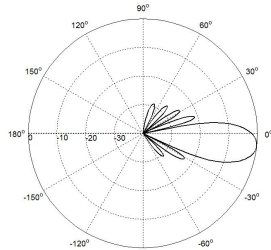

Elevation(698-960MHz)

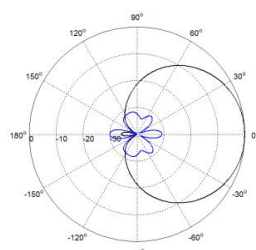

Azimuth(1695-2690MHz)

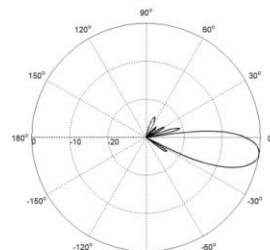

Elevation(1695-2690MHz)

S-VUL4PX7.3.3PF3-E2-C

Correlation Table

Frequency Range	Array	Connector	RET
698–960 MHz	R1	1-2	BRxxx.....R1
1695–2690 MHz	Y1	3-4	BRxxx.....Y1
1695–2690 MHz	Y2	5-6	BRxxx.....Y2
1695–2690 MHz	Y3	7-8	BRxxx.....Y3
1695–2690 MHz	Y4	9-10	BRxxx.....Y4
3300-3800 MHz	P1	1xMQ5,1xMQ4	BRxxx.....P1

MQ4/MQ5 Port Mapping

Connector	Pin	Frequency	Polarization/Port
MQ5	1	3300-3800 MHz	+45
	2	3300-3800 MHz	+45
	3	3300-3800 MHz	+45
	4	3300-3800 MHz	+45
	5	3300-3800 MHz	Calibration port
MQ4	1	3300-3800 MHz	-45
	2	3300-3800 MHz	-45
	3	3300-3800 MHz	-45
	4	3300-3800 MHz	-45

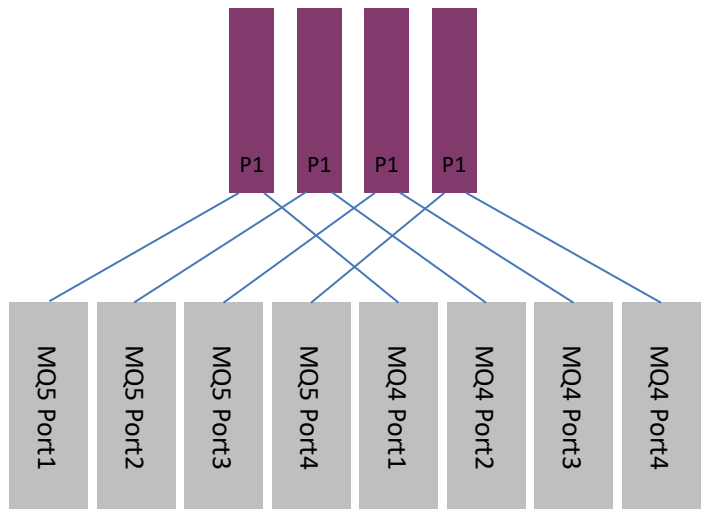
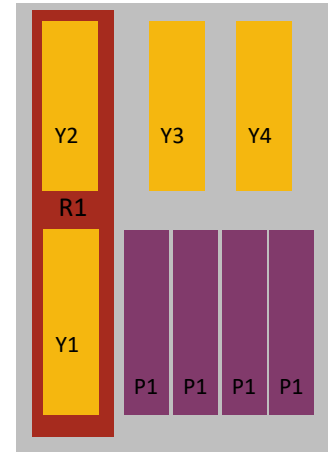

Bottom View

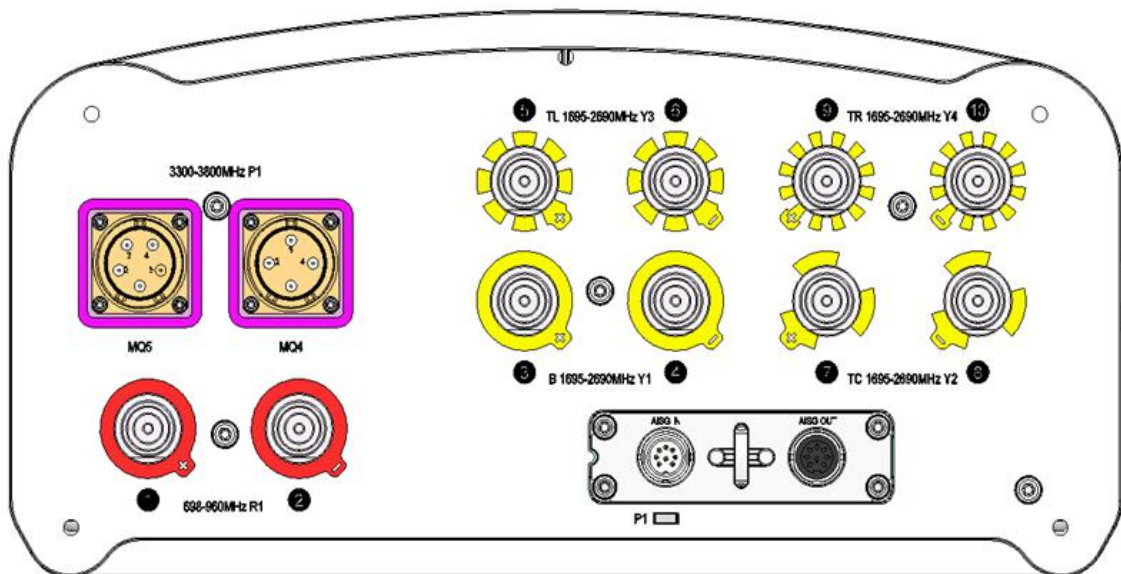

S-VUL4PX7.3.3PF3-E2-C**Broadcast Beam Weight Value for Reference**

		P1/P5	P2/P6	P3/P7	P4/P8
2C(3300-3800MHz)	Amp[li]	1	1	0.65	0.25
	Phase	0	-20	180	-20
3C(3300-3800MHz)	Amp[li]	1	1	0.65	0.25
	Phase	0	-16	180	-16
4C(3300-3800MHz)	Amp[li]	1	1	0.65	0.25
	Phase	0	-12	180	-12
5C(3300-3800MHz)	Amp[li]	1	1	0.65	0.25
	Phase	0	-8	180	-8
6C(3300-3800MHz)	Amp[li]	1	1	0.65	0.25
	Phase	0	-4	180	-4
7C(3300-3800MHz)	Amp[li]	1	1	0.65	0.25
	Phase	0	0	180	0
8C(3300-3800MHz)	Amp[li]	1	1	0.65	0.25
	Phase	0	4	180	4
9C(3300-3800MHz)	Amp[li]	1	1	0.65	0.25
	Phase	0	8	180	8
10C(3300-3800MHz)	Amp[li]	1	1	0.65	0.25
	Phase	0	12	180	12
11C(3300-3800MHz)	Amp[li]	1	1	0.65	0.25
	Phase	0	16	180	16
12C(3300-3800MHz)	Amp[li]	1	1	0.65	0.25
	Phase	0	20	180	20

S-VUL4PX10.5.5P-E2-C

X Pol Panel TD Antenna 3300-3800MHz 80° 15dBi 2°-12° Replaceable RET

XXXXX Pol 698-960/4×1695-2690MHz 65°/65° 14/14dBi 2°-12°/2°-12° Replaceable RET

Electrical Specifications (3300-3800MHz)

General parameters	Frequency range (MHz):		3300-3800(P1)	
	Polarization:		±45°	
	Electrical downtilt (°):		2-12 , continuously adjustable	
	Connector Type:		1xMQ5,1xMQ4	
Calibration and electrical parameters	Coupling factor between calibration port and each antenna port (dB) :		-26±2	
	Max Amp/phase Deviation:		<1.2/ 12°	
	VSWR:		<1.5	
	Max. Power Per Port (W):		40	
	Co-polarization isolation between ports (dB):		>20	
Radiation parameters	Single Column	Horizontal 3dB Beamwidth (°):		80±10
		Vertical 3dB Beamwidth (°):		7
		Front to Back Ratio (dB):		23
		Gain (dBi):		14.5±0.5
		Cross polar ratio (dB):		>15 (0°)/>8 (±60°)
	Broadcast Beam	Horizontal 3dB Beamwidth (°):		65±10
		Gain (dBi):		16.0±0.5
		Front to Back Ratio (dB):		25
		Vertical 3dB Beamwidth (°):		7
		Cross polar ratio (dB):		>15 (0°)/>8 (±60°)
	Service Beam @ 0deg	Gain (dBi):		19.5±0.5
		Horizontal 3dB Beamwidth (°):		19
		Horizontal Sidelobe Level (dB):		<-12
		Cross polar ratio (0°) (dB):		15
		Front to Back Ratio (dB):		25
Service Beam@ 60deg	Gain (dBi):		16.0±0.5	
	Horizontal 3dB Beamwidth (°):		20	
	Horizontal Sidelobe Level (dB):		<-3	

Electrical Specifications (698-960/1695-2690 MHz)

Frequency Range (MHz):	698-960(R1)			1695-2690(Y1,Y2,Y3,Y4)		
	698-806	806-880	880-960	1695-2170	2300-2490	2490-2690
Gain (dBi):	13.0±0.5	13.5±0.5	14.0±0.5	13.2±0.5	13.8±0.5	14.0±0.5
Return Loss (dB):	>14 (VSWR<1.5)					
Polarization:	±45°					
Horizontal 3dB beamwidth (°):	65	62	58	68	65	60
Vertical 3dB beamwidth (°):	17.5	16.0	15.0	13.5	11.5	11.0
Electrical Downtilt (°):	2-12 Continuously Adjustable			2-12 Independently Continuously Adjustable		
Front to Back Ratio @180±30°(dB):	22	23	24	25	25	25
1st Upper Sidelobe Suppression (dB):	15	15	15	15	15	15
Cross Polar Ratio 0° (dB):	15	15	15	15	15	15
Intraband Isolation (dB):	>24					
Interband Isolation (dB):	>24					

Product Data Sheet

S-VUL4PX10.5.5P-E2-C

Max. Power Per Port (W):	250	200
Intermodulation IM3 (dBc):	<-150 (2×43dBm)	
Impedance (ohm):	50	
Lightning Protection:	DC Grounded	
Connector Type:	10x4.3-10 Female	

BASTA Electrical Specifications

Frequency Range(MHz):	698-960(R1)			4×1695-2690(Y1,Y2,Y3,Y4)			3300-3800(P1)
	698-806	806-880	880-960	1695-2170	2300-2490	2490-2690	
Average Gain by all Beam Tilts (dBi):	12.8	13.0	13.6	13.0	13.3	13.9	14.1
Gain by all Beam Tilts Tolerance(dB):	±0.5	±0.5	±0.5	±1.4	±1.1	±0.7	±0.9
Average Gain by Beam Tilt (dBi):	2° 13.0	2° 13.1	2° 13.9	2° 13.1	2° 13.4	2° 14.2	2° 14.6
	7° 12.8	7° 12.9	7° 13.7	7° 12.9	7° 13.3	7° 14.0	7° 14.0
	12° 12.6	12° 12.8	12° 13.3	12° 12.8	12° 12.9	12° 13.5	12° 13.2
Horizontal Beamwidth Tolerance(°):	±4.2	±3.5	±4.6	±6.5	±4.1	±6.0	±12.1
Vertical Beamwidth Tolerance(°):	±1.9	±1.9	±1.6	±2.3	±1.7	±1.4	±1.5
1st Upper Sidelobe Suppression (dB) :	15.9	15.6	15.8	15.5	15.9	15.1	15.8
Front to back Total Power at 180° ± 30°(dB):	22.2	23.5	24.2	25.2	25.8	25.3	23.5
CPR at Boresight(dB):	15.9	17.6	16.5	15.7	16.9	16.9	16.8

Mechanical Data

Antenna Dimensions (mm):	1390×396×190
Packing Dimensions (mm):	1680×485×285
Antenna Net Weight/Bracket (kg): (kg):	25/5.7
Antenna Gross Weight (kg):	35
Radome Material:	Fiberglass
Pipe OD (mm):	70-114
Mounting Kits (Included):	BA.K.04.00053, Adjustable Downtilt 0°-14°

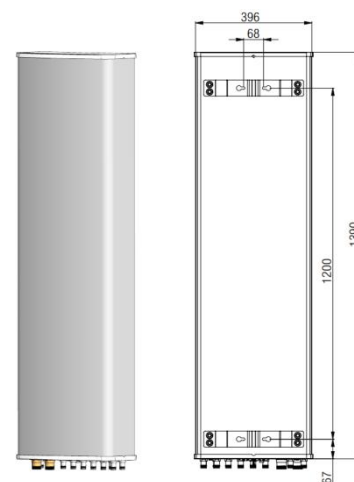

Environmental Ratings

Humidity:	95%RH@+30°C
Temperature (°C):	-40~+70
Wind Load @150 km/h (N):	Frontal/ Lateral/ Rearside:732/218/966
Max. Wind velocity(km/h):	200

Internal RET Specifications

RET type:	RET Replaceable RET
RET protocol:	AISG 2.0 /3 GPP
Input voltage range(V):	10-30 DC
Power consumption (W):	< 5 (motor activated , single RET) < 1 (stand by, single RET), < 1.5 (stand by, 12V)
Adjustment time (full range) (s):	< 120 (typically, depending on antenna type)
RET connector:	one pair of AISG 5 pin male & female
Pin assignment according AISG:	8 pin circular connector conforming to IEC 60130-9 - Ed. 3.0
Lightning protection (kA):	5 (8/20 μs Differential mode), 8 (8/20 μs Common mode)

S-VUL4PX10.5.5P-E2-C

Typical Patterns

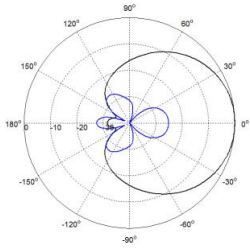

Single Column

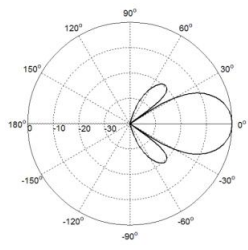

Service Beam @0deg

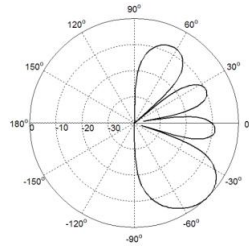

Service Beam @60deg

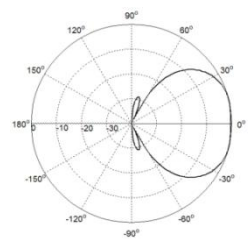

Broadcast Beam

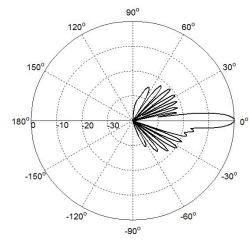

Elevation

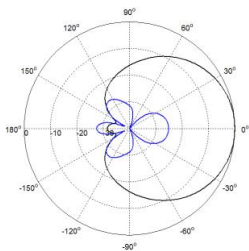

Azimuth(698-960MHz)

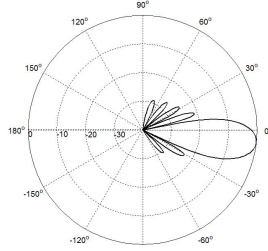

Elevation(698-960MHz)

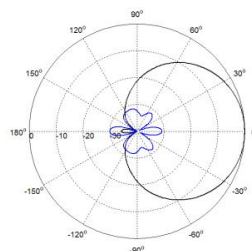

Azimuth(1695-2690MHz)

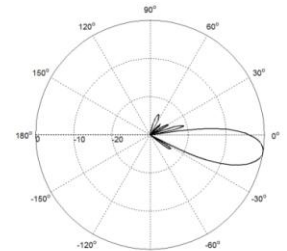

Elevation(1695-2690MHz)

Correlation Table

Frequency Range	Array	Connector	RET
698-960 MHz	R1	1-2	BRxxx.....R1
1695-2690 MHz	Y1	3-4	BRxxx.....Y1
1695-2690 MHz	Y2	5-6	BRxxx.....Y2
1695-2690 MHz	Y3	7-8	BRxxx.....Y3
1695-2690 MHz	Y4	9-10	BRxxx.....Y4
3300-3800 MHz	P1	1xMQ5,1xMQ4	BRxxx.....P1

MQ4/MQ5 Port Mapping

Connector	Pin	Frequency	Polarization/Port
MQ5	1	3300-3800 MHz	+45
	2	3300-3800 MHz	+45
	3	3300-3800 MHz	+45
	4	3300-3800 MHz	+45
	5	3300-3800 MHz	Calibration port
MQ4	1	3300-3800 MHz	-45
	2	3300-3800 MHz	-45
	3	3300-3800 MHz	-45
	4	3300-3800 MHz	-45

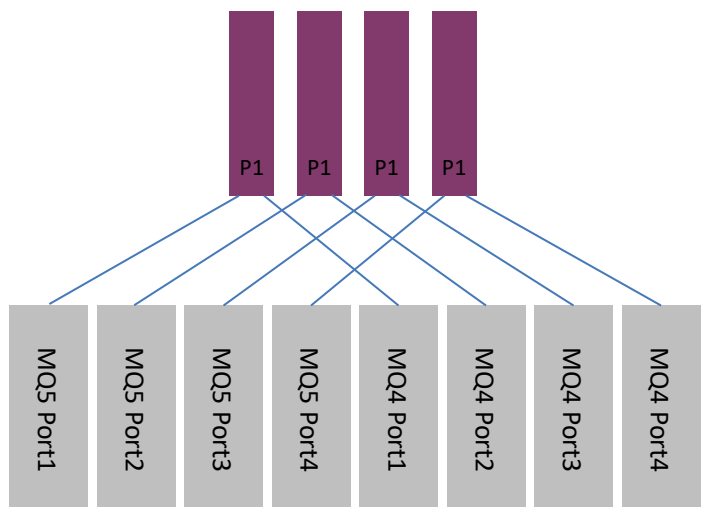
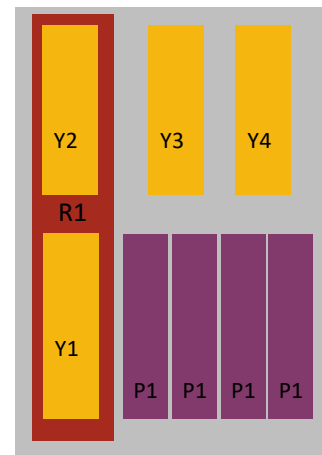

S-VUL4PX10.5.5P-E2-C

Bottom View

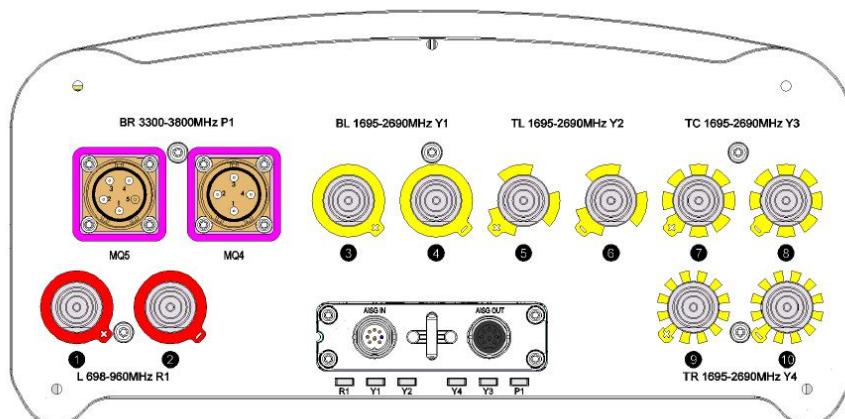

Broadcast Beam Weight Value for Reference

		P1/P5	P2/P6	P3/P7	P4/P8
2C(3300-3800MHz)	Amp[li]	1	1	0.65	0.25
	Phase	0	-20	180	-20
3C(3300-3800MHz)	Amp[li]	1	1	0.65	0.25
	Phase	0	-16	180	-16
4C(3300-3800MHz)	Amp[li]	1	1	0.65	0.25
	Phase	0	-12	180	-12
5C(3300-3800MHz)	Amp[li]	1	1	0.65	0.25
	Phase	0	-8	180	-8
6C(3300-3800MHz)	Amp[li]	1	1	0.65	0.25
	Phase	0	-4	180	-4
7C(3300-3800MHz)	Amp[li]	1	1	0.65	0.25
	Phase	0	0	180	0
8C(3300-3800MHz)	Amp[li]	1	1	0.65	0.25
	Phase	0	4	180	4
9C(3300-3800MHz)	Amp[li]	1	1	0.65	0.25
	Phase	0	8	180	8
10C(3300-3800MHz)	Amp[li]	1	1	0.65	0.25
	Phase	0	12	180	12
11C(3300-3800MHz)	Amp[li]	1	1	0.65	0.25
	Phase	0	16	180	16
12C(3300-3800MHz)	Amp[li]	1	1	0.65	0.25
	Phase	0	20	180	20

S-VU2L4PX7.3.3PF3-2C

X Pol Panel TD Antenna 3300-3800MHz 65° 13.5dBi 2°-12° Replaceable RET

XXXXXX Pol 2×698-960/4×1710-2690MHz 65°/65° 12/13dBi 3°/3° FET

Electrical Specifications (3300-3800MHz)

Electrical Specifications (3300-3800MHz)			
General Parameters	Frequency range (MHz):	3300-3800(P1)	
	Polarization:	±45	
	Electrical downtilt (°):	2-12 ,continuously adjustable	
	Grounding:	DC Grounded	
	Connector Type:	1xMQ5,1xMQ4	
Calibration and electrical parameters	Coupling factor between calibration port and each antenna port (dB) :	-26±2	
	Max Amp/phase Deviation:	<1.2dB/12°	
	VSWR:	<1.5	
	Max. Power Per Port (W):	40	
	Isolation (dB):	>20	
Radiation parameters	Single Column	Horizontal 3dB Beamwidth (°):	70±10
		Vertical 3dB Beamwidth (°):	9.5
		Front to Back Ratio (dB):	23
		Gain (dBi):	13.2±0.5
		Cross polar ratio (dB):	>15 (0°)/>8 (±60°)
	Broadcast Beam	Horizontal 3dB Beamwidth (°):	65±10
		Gain (dBi):	14.7±0.5
		Front to Back Ratio (dB):	25
		Vertical 3dB Beamwidth (°):	9.5
		Cross polar ratio (dB):	>15 (0°)/>8 (±60°)
	Service Beam @ 0deg	Gain (dBi):	18.2±0.5
		Horizontal 3dB Beamwidth (°):	20
		Horizontal Sidelobe Level (dB):	<-12
		Cross polar ratio (0°) (dB):	15
		Front to Back Ratio (dB):	25



Product Data Sheet

S-VU2L4PX7.3.3PF3-2C

Electrical Specifications (698-960/1710-2690 MHz)						
Frequency Range (MHz):	698-960(R1,R2)			1710-2690(Y1,Y2,Y3,Y4)		
	698-806	806-880	880-960	1710-2170	2300-2490	2490-2690
Gain (dBi):	11.0±0.6	11.0±0.5	11.3±0.8	11.3±0.6	12.5±0.5	13.0±0.5
Return Loss (dB):	>14 (VSWR<1.5)					
Polarization:	±45°					
Horizontal 3dB beamwidth (°):	64	67	70	65	62	58
Vertical 3dB beamwidth (°):	28	24	22	25	22	20
1 st Upper Sidelobe Suppression(dB):	>11	>11	>11	>12	>12	>12
Front to Back Ratio(dB):	>23	>25	>23	>25	>26	>24
Electrical Downtilt (°):	3 Fixed					
Polarization Isolation (dB):	>23					
Interband Isolation (dB):	>23					
Max. Power Per Port (W):	150			100		
Intermodulation IM3 (dBc):	<-150 (2×43dBm)					
Impedance (ohm):	50					
Lightning Protection:	DC Grounded					
Connector Type:	12x4.3-10 Female					

BASTA Electrical Specifications

Frequency Range(MHz):	698-960(R1,R2)			1710-2690(Y1,Y2,Y3,Y4)			3300-3800(P1)
	698-806	806-880	880-960	1710-2170	2300-2490	2490-2690	
Average Gain by all Beam Tilts (dBi):	10.9	11.2	11.0	12.0	12.8	12.9	13.5
Gain by all Beam Tilts Tolerance(dB):	±0.4	±0.6	±0.3	±0.7	±0.7	±0.7	±0.6
Average Gain by Beam Tilt (dBi):	3° 10.9	3° 11.2	3° 11.0	3° 12.0	3° 12.8	3° 12.9	2° 13.5 7° 13.6 12° 13.5
Horizontal Beamwidth Tolerance(°):	±9.0	±13.0	±12.8	±8.0	±7.7	±8.7	±6.8
Vertical Beamwidth Tolerance(°):	±2.1	±1.7	±1.0	±2.8	±3.6	±4.2	±1.0
1st Upper Sidelobe Suppression (dB) :	15.0	10.0	11.0	13.7	14.2	12.5	11.5
Front to back Total Power at 180° ± 30°(dB):	22.0	24.0	22.0	24.0	24.0	23.0	23.0
CPR at Boresight(dB):	15	16	16	18.8	19.0	17.3	17.5



Product Data Sheet

S-VU2L4PX7.3.3PF3-2C

Mechanical Data

Antenna Dimensions (mm):	895×498×197
Packing Dimensions (mm):	1155×580×285
Antenna Net Weight/Bracket (kg):	18/5.9
Antenna Gross Weight (kg):	27.5
Radome Material:	Fiberglass
Pipe OD (mm):	50-115
Mounting Kits (Included):	BA.K.04.00069381, Adjustable Downtilt 0°-30°

Environmental Ratings

Humidity:	95%RH@+30°C
Temperature (°C):	-40~+70
Wind Load @150 km/h (N):	Frontal/Lateral/Rearside: 558/100/566
Max. Wind velocity (km/h) :	200

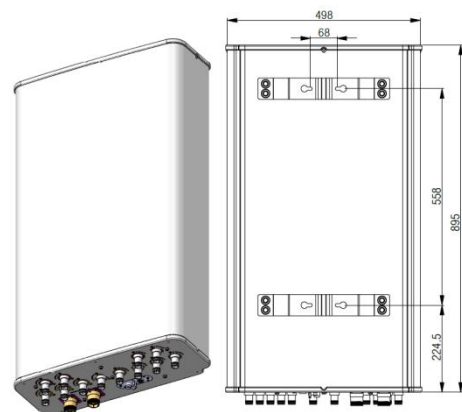

Internal RET Specifications

RET type:	Replaceable RET
RET protocol:	AISG 2.0 /3 GPP
Input voltage range(V):	10-30 DC
Power consumption(W):	< 5 (motor activated, single RET) < 1 (stand by, single RET), < 1.5 (stand by, 12V)
Adjustment time (full range) (s):	< 120 (typically, depending on antenna type)
RET connector:	1 pair of AISG 5 pin male & female
Pin assignment according AISG:	8 pin circular connector conforming to IEC 60130-9 - Ed. 3.0
Lightning protection (kA):	5 (8/20 μs Differential mode), 8 (8/20 μs Common mode)



S-VU2L4PX7.3.3PF3-2C

Typical Patterns

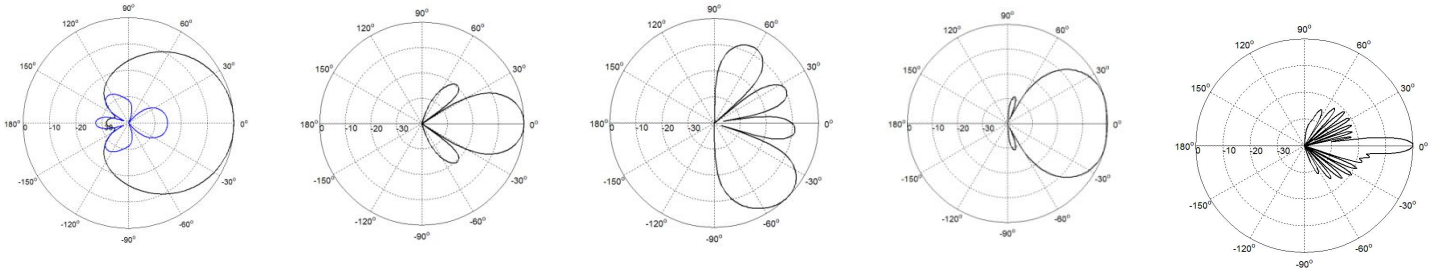

Single Column

Service Beam @0deg

Service Beam @60deg

Broadcast Beam

Elevation

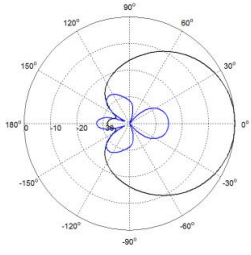

Azimuth(698–960MHz)

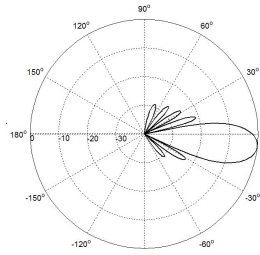

Elevation(698–960MHz)

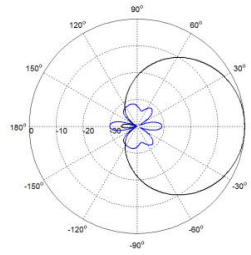

Azimuth(1710–2690MHz)

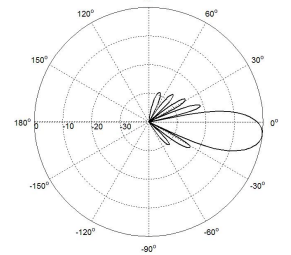

Elevation(1710–2690MHz)

Bottom View

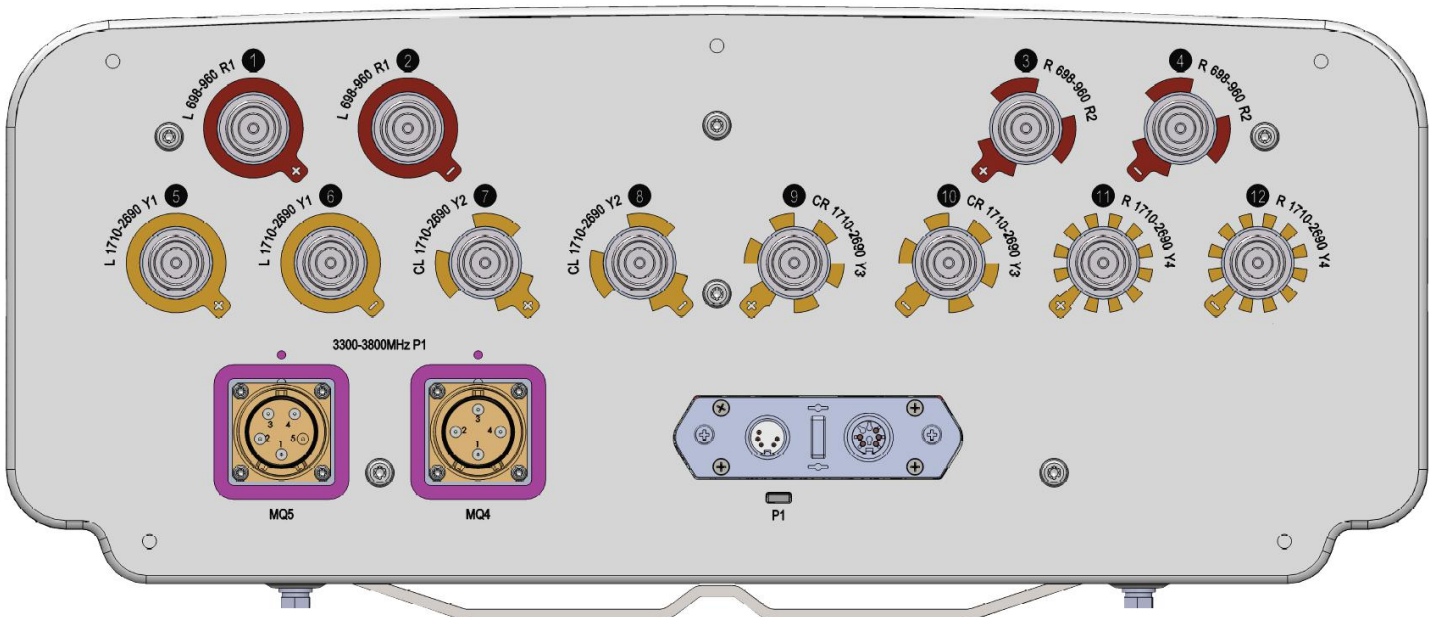

S-VU2L4PX7.3.3PF3-2C

Correlation Table

Frequency Range	Array	Connector	RET
698–960 MHz	R1	1-2	/
698–960 MHz	R2	3-4	/
1710–2690 MHz	Y1	5-6	/
1710–2690 MHz	Y2	7-8	/
1710–2690 MHz	Y3	9-10	/
1710–2690 MHz	Y4	11-12	/
3300-3800 MHz	P1	1xMQ5,1xMQ4	BRxxx……P1

MQ4/MQ5 Port Mapping

Connector	Pin	Frequency Range	Polarization/Port
MQ5	1	3300-3800 MHz	+45
	2	3300-3800 MHz	+45
	3	3300-3800 MHz	+45
	4	3300-3800 MHz	+45
	5	3300-3800 MHz	Calibration port
MQ4	1	3300-3800 MHz	-45
	2	3300-3800 MHz	-45
	3	3300-3800 MHz	-45
	4	3300-3800 MHz	-45

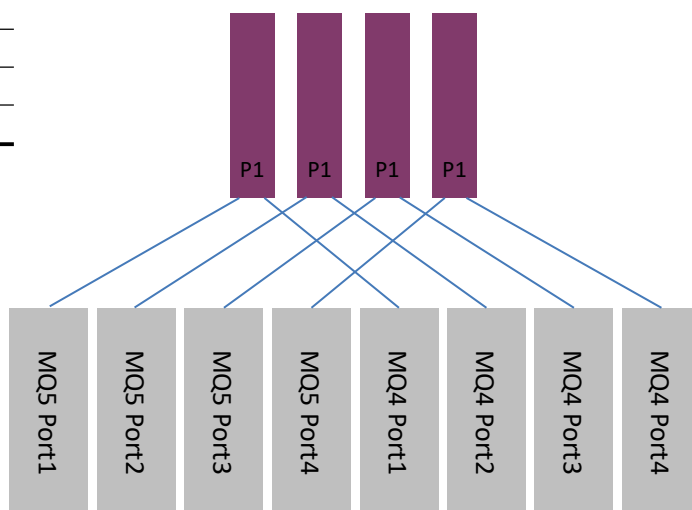
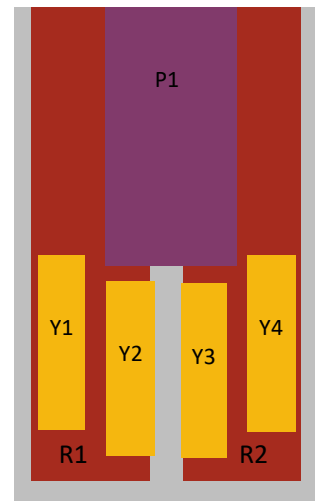

S-VU2L4PX7.3.3PF3-2C**Broadcast Beam Weight Value for Reference**

		MQ5-P1/MQ4-P1	MQ5-P2/MQ4-P2	MQ5-P3/MQ4-P3	MQ5-P4/MQ4-P4
2C(3300-3800MHz)	Amp[li]	0.31	1	0.63	0.1
	Phase	170	-30	0	-40
3C(3300-3800MHz)	Amp[li]	0.31	1	0.63	0.1
	Phase	170	-26	0	-36
4C(3300-3800MHz)	Amp[li]	0.31	1	0.63	0.1
	Phase	170	-22	0	-32
5C(3300-3800MHz)	Amp[li]	0.31	1	0.63	0.1
	Phase	170	-18	0	-28
6C(3300-3800MHz)	Amp[li]	0.31	1	0.63	0.1
	Phase	170	-14	0	-24
7C(3300-3800MHz)	Amp[li]	0.31	1	0.63	0.1
	Phase	170	-10	0	-20
8C(3300-3800MHz)	Amp[li]	0.31	1	0.63	0.1
	Phase	170	-6	0	-16
9C(3300-3800MHz)	Amp[li]	0.31	1	0.63	0.1
	Phase	170	-2	0	-12
10C(3300-3800MHz)	Amp[li]	0.31	1	0.63	0.1
	Phase	170	2	0	-8
11C(3300-3800MHz)	Amp[li]	0.31	1	0.63	0.1
	Phase	170	6	0	-4
12C(3300-3800MHz)	Amp[li]	0.31	1	0.63	0.1
	Phase	170	10	0	0



Product Data Sheet

S-VU2L4PX8.4.4P-2C

X Pol Panel TD Antenna 3300-3800MHz 80° 14dBi 2°-12° Replaceable RET

XXXXXX Pol 2×698-960/4×1710-2690MHz 65°/65° 12/14dBi 2°-16°/2°-12° Replaceable RET

Electrical Specifications (3300-3800MHz)

Electrical Specifications (3300-3800MHz)			
General parameters	Frequency range (MHz):	3300-3800(P1)	
	Polarization:	±45°	
	Electrical downtilt (°):	2-12 , continuously adjustable	
	Connector Type:	1xMQ5,1xMQ4	
Calibration and electrical parameters	Coupling factor between calibration port and each antenna port (dB) :	-26±2	
	Max Amp/phase Deviation:	<1.2/ 12°	
	VSWR:	<1.5	
	Max. Power Per Port (W):	40	
	Interband Isolation (dB):	>20	
	Polarization Isolation (dB):	>20	
Radiation parameters	Single Column	Horizontal 3dB Beamwidth (°):	70±10
		Vertical 3dB Beamwidth (°):	9
		Front to Back Ratio (dB):	23
		Gain (dBi):	13.5±0.5
		Cross polar ratio (dB):	>15 (0°)/>8 (±60°)
	Broadcast Beam	Horizontal 3dB Beamwidth (°):	65±10
		Gain (dBi):	15±0.5
		Front to Back Ratio (dB):	25
		Vertical 3dB Beamwidth (°):	9
		Cross polar ratio (dB):	>15 (0°)/>8 (±60°)
		1 st Upper Sidelobe Suppression (dB):	>13
	Service Beam @ 0deg	Gain (dBi):	19±0.5
		Horizontal 3dB Beamwidth (°):	20
		Horizontal Sidelobe Level (dB):	<-12
		Cross polar ratio (0°) (dB):	15
		Front to Back Ratio (dB):	25

Product Data Sheet

S-VU2L4PX8.4.4P-2C**Electrical Specifications (698-960/1710-2690 MHz)**

Frequency Range (MHz):	698-960(R1,R2)			1710-2690(Y2,Y3)			1710-2690(Y1,Y4)		
	698-806	806-880	880-960	1710 -2170	2300 -2490	2490 -2690	1710 -2170	2300 -2490	2490 -2690
Gain (dBi):	11.3 ±0.5	12.0 ±0.5	12.2 ±0.5	12.3 ±0.5	13.4 ±0.5	13.7 ±0.5	12.5 ±0.5	13.1 ±0.5	13.5 ±0.5
Return Loss (dB):	>14 (VSWR<1.5)								
Polarization:	±45°								
Horizontal 3dB beamwidth (°):	73	63	55	62	61	57	66	64	61
Vertical 3dB beamwidth (°):	23	21	19	18	16	15	18	16	15
Electrical Downtilt (°):	2-16 Independently Continuously Adjustable			2-12 Independently Continuously Adjustable					
Intraband Isolation (dB):	>25								
Interband Isolation (dB):	>25								
Max. Power Per Port (W):	250			200					
Intermodulation IM3 (dBc):	<-150 (2×43dBm)								
Impedance (ohm):	50								
Lightning Protection:	DC Grounded								
Connector Type:	12x4.3-10 Female								

Mechanical Data

Antenna Dimensions (mm):	1095×498×197
Packing Dimensions (mm):	1365×585×290
Antenna Net Weight/Bracket (kg):	24/5.9
Antenna Gross Weight (kg):	35
Radome Material:	Fiberglass
Pipe OD (mm):	50-115
Mounting Kits (Included):	BA.K.04.00069151, Adjustable Downtilt 0°-20°

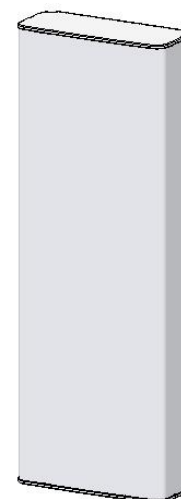
**Environmental Ratings**

Humidity:	95%RH@+30°C
Temperature (°C):	-40~+70
Wind Load @150 km/h (N):	Frontal/Lateral/Rearside: 689/123/699
Max. Wind velocity (km/h) :	200

Internal RET Specifications

RET type:	Replaceable RET
RET protocol:	AISG 2.0 /3 GPP
Input voltage erange(V):	10-30 DC
Power consumption(W):	< 5 (motor activated, single RET) < 1 (stand by, single RET), < 1.5 (stand by, 12V)
Adjustment time (full range) (s):	< 120 (typically, depending on antenna type)
RET connector:	1 pair of AISG 5 pin male & female
Pin assignment according AISG:	8 pin circular connector conforming to IEC 60130-9 - Ed. 3.0
Lightning protection (kA):	5 (8/20 μs Differential mode), 8 (8/20 μs Common mode)

Product Data Sheet

S-VU2L4PX8.4.4P-2C

Typical Patterns

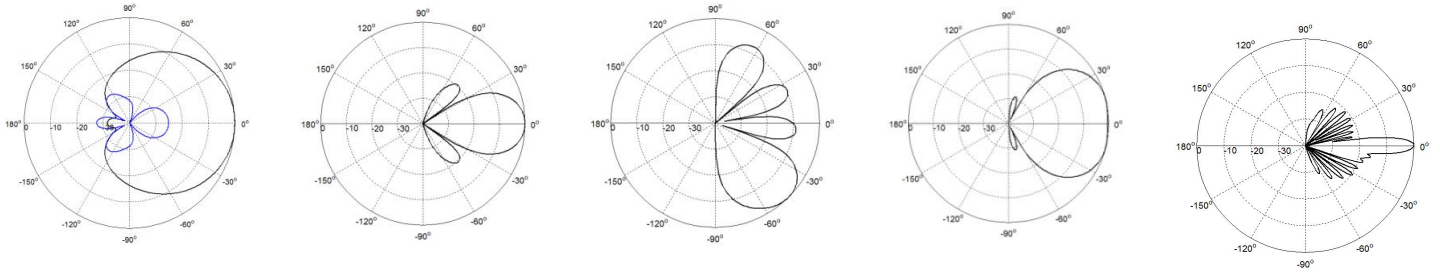

Single Column

Service Beam @0deg

Service Beam @60deg

Broadcast Beam

Elevation

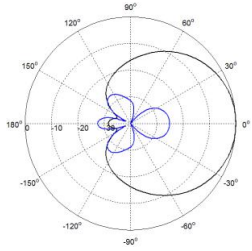

Azimuth(698-960MHz)

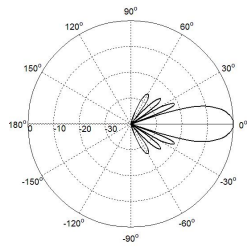

Elevation(698-960MHz)

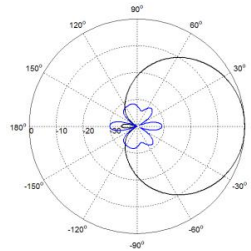

Azimuth(1710-2690MHz)

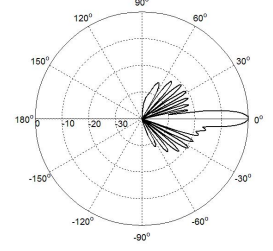

Elevation(1710-2690MHz)

Correlation Table

Frequency Range	Array	Connector
698-960 MHz	R1	1-2
698-960 MHz	R2	3-4
1710-2690 MHz	Y1	5-6
1710-2690 MHz	Y2	7-8
1710-2690 MHz	Y3	9-10
1710-2690 MHz	Y4	11-12
3300-3800 MHz	P1	1xMQ5,1xMQ4

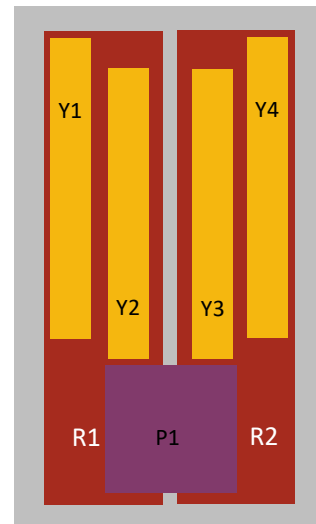

S-VU2L4PX10.5.5P-2C

X Pol Panel TD Antenna 3300-3800MHz 65° 15dBi 2°-12° Replaceable RET

XXXXXX Pol 2×698-960/4×1710-2690MHz 65°/65° 14/14.5dBi 2°-12°/2°-12° Replaceable RET

Electrical Specifications (3300-3800MHz)

Electrical Specifications (3300-3800MHz)			
General Parameters	Frequency range (MHz):	3300-3800(P1)	
	Polarization:	±45	
	Electrical downtilt (°):	2-12 ,continuously adjustable	
	Grounding:	DC Grounded	
	Connector Type:	1xMQ5,1xMQ4	
Calibration and electrical parameters	Coupling factor between calibration port and each antenna port (dB) :	-26±2	
	Max Amp/phase Deviation:	<1.2dB/12°	
	VSWR:	<1.5	
	Max. Power Per Port (W):	40	
	Isolation (dB):	>20	
Radiation parameters	Single Column	Horizontal 3dB Beamwidth (°):	70±10
		Vertical 3dB Beamwidth (°):	7
		Front to Back Ratio (dB):	23
		Gain (dBi):	14.5±0.5
		Cross polar ratio (dB):	>15 (0°)/ >6 (±60°)
	Broadcast Beam	Horizontal 3dB Beamwidth (°):	65±10
		Gain (dBi):	16.0±0.5
		Front to Back Ratio (dB):	25
		Vertical 3dB Beamwidth (°):	7
		Cross polar ratio (dB):	>15 (0°)/ >8(±60°)
	Service Beam @ 0deg	1 st Upper Sidelobe Suppression (dB):	>14
		Gain (dBi):	20.0±0.5
		Horizontal 3dB Beamwidth (°):	20
		Horizontal Sidelobe Level (dB):	<-12
		Cross polar ratio (0°) (dB):	15
	Front to Back Ratio (dB):	25	



Product Data Sheet

S-VU2L4PX10.5.5P-2C

Electrical Specifications (698-960/1710-2690 MHz)									
Frequency Range (MHz):	698-960(R1,R2)			1710-2690(Y2,Y3)			1710-2690(Y1,Y4)		
	698-806	806-880	880-960	1710 -2170	2300 -2490	2490 -2690	1710 -2170	2300 -2490	2490 -2690
Gain (dBi):	12.6 ±0.5	12.9 ±0.5	13.1 ±0.5	13.4 ±0.5	14.1 ±0.5	14.8 ±0.5	13.5 ±0.5	14 ±0.5	14.4 ±0.5
Return Loss (dB):	>14 (VSWR<1.5)								
Polarization:	±45°								
Horizontal 3dB beamwidth (°):	66	64	62	64	61	55	67	64	60
Vertical 3dB beamwidth (°):	17.6	15.9	13.6	14.1	12.4	10.8	14.2	12.7	11.2
Electrical Downtilt (°):	2-12 Independently Continuously Adjustable			2-12 Independently Continuously Adjustable					
Intraband Isolation (dB):	>25								
Interband Isolation (dB):	>25								
Max. Power Per Port (W):	250			200					
Intermodulation IM3 (dBc):	<-150 (2x43dBm)								
Impedance (ohm):	50								
Lightning Protection:	DC Grounded								
Connector Type:	12x4.3-10 Female								

BASTA Electrical Specifications

Frequency Range(MHz):	698-960(R1,R2)			4x1695-2690(Y2,Y3)			1710-2690(Y1,Y4)			3300-
	698 -806	806 -880	880 -960	1710 -2170	2300 -2490	2490 -2690	1710 -2170	2300 -2490	2490 -2690	3800 (P1)
Average Gain by all Beam Tilts (dBi):	12.5	12.8	13	13.3	13.9	14.4	13.4	13.8	14.1	14.5
Gain by all Beam Tilts Tolerance(dB):	±0.6	±0.6	±0.5	±0.9	±0.8	±1.1	±0.9	±0.7	±0.6	±0.7
Average Gain by Beam Tilt (dBi):	2° 12.6 7° 12.6 12° 12.4	2° 12.9 7° 12.9 12° 12.7	2° 13.0 7° 13.1 12° 12.7	2° 13.4 7° 13.4 12° 13.2	2° 14.1 7° 14.0 12° 13.6	2° 14.8 7° 14.3 12° 13.9	2° 13.5 7° 13.5 12° 13.3	2° 14 7° 14 12° 13.5	2° 14.4 7° 14.2 12° 13.7	2° 14.3 7° 14.6 12° 14.4
Horizontal Beamwidth Tolerance(°):	±5.7	±10.3	±10.8	±6.5	±5	±4.6	±6.6	±5.8	±4.8	±6.1
Vertical Beamwidth Tolerance(°):	±1.4	±1.3	±0.9	±1.6	±1.3	±0.8	±1.9	±1.4	±0.8	±0.7
1 st Upper Sidelobe Suppression (dB) :	17	16	14	13	14	13	13	13	12	13
Front to back	18	19	20	22	22	22	22	22	21	22
CPR at Boresight(dB):	19	20	20	20	20	20	20	20	20	13

Mechanical Data

Antenna Dimensions (mm):	1395x498x197
Packing Dimensions (mm):	1665x585x290
Antenna Net Weight/Bracket (kg):	29.5/5.9
Antenna Gross Weight (kg):	40.5
Radome Material:	Fiberglass
Pipe OD (mm):	50-115
Mounting Kits (Included):	BA.K.04.00069351, Adjustable Downtilt 0°-16°

Environmental Ratings

Humidity:	95%RH@+30°C
Temperature (°C):	-40~+70
Wind Load @150 km/h (N):	Frontal/Lateral/Rearside:887/158/900
Max. Wind velocity (km/h) :	200

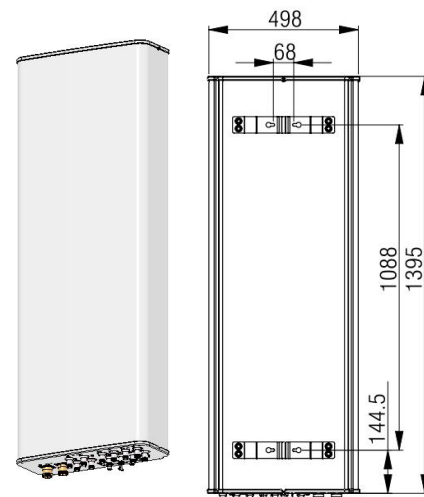

S-VU2L4PX10.5.5P-2C

Internal RET Specifications

RET type:	Replaceable RET
RET protocol:	AISG 2.0 /3 GPP
Input voltage range(V):	10-30 DC
Power consumption(W):	< 5 (motor activated, single RET) < 1 (stand by, single RET), < 1.5 (stand by, 12V)
Adjustment time (full range) (s):	< 120 (typically, depending on antenna type)
RET connector:	1 pair of AISG 5 pin male & female
Pin assignment according AISG:	8 pin circular connector conforming to IEC 60130-9 - Ed. 3.0
Lightning protection (kA):	5 (8/20 μ s Differential mode), 8 (8/20 μ s Common mode)

Typical Patterns

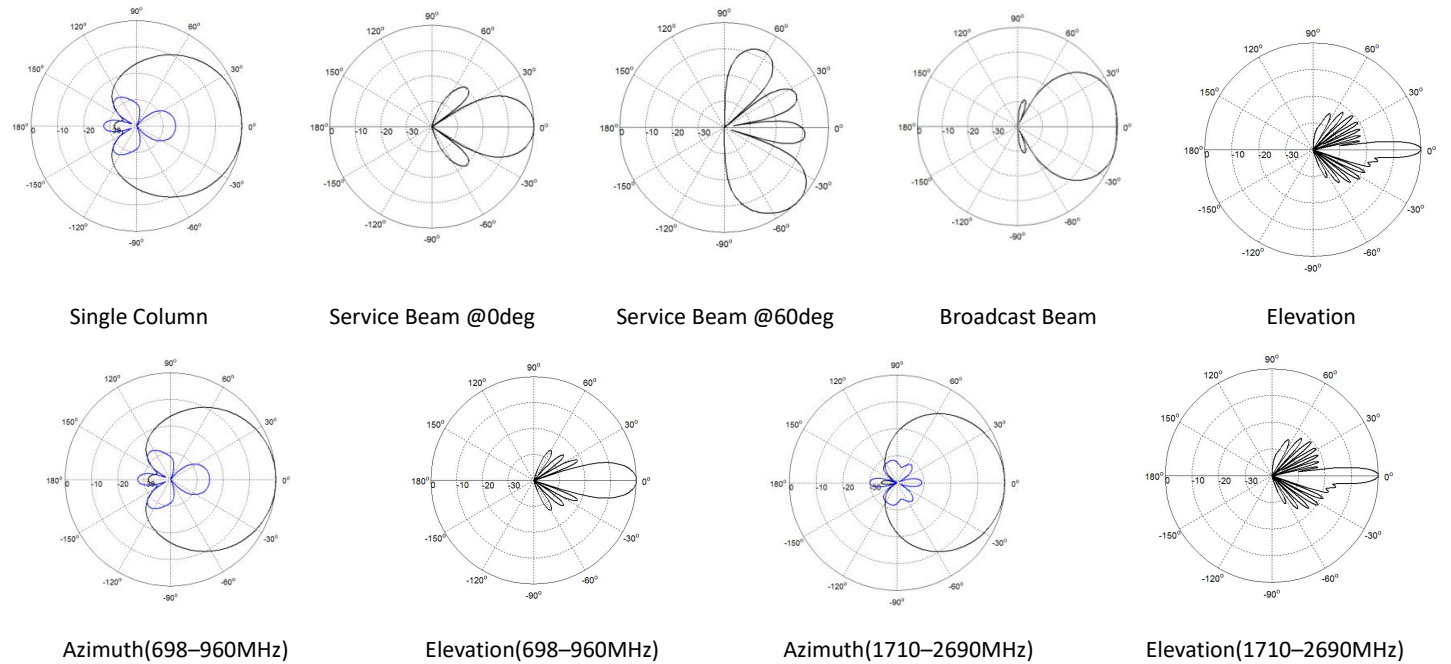

Bottom View

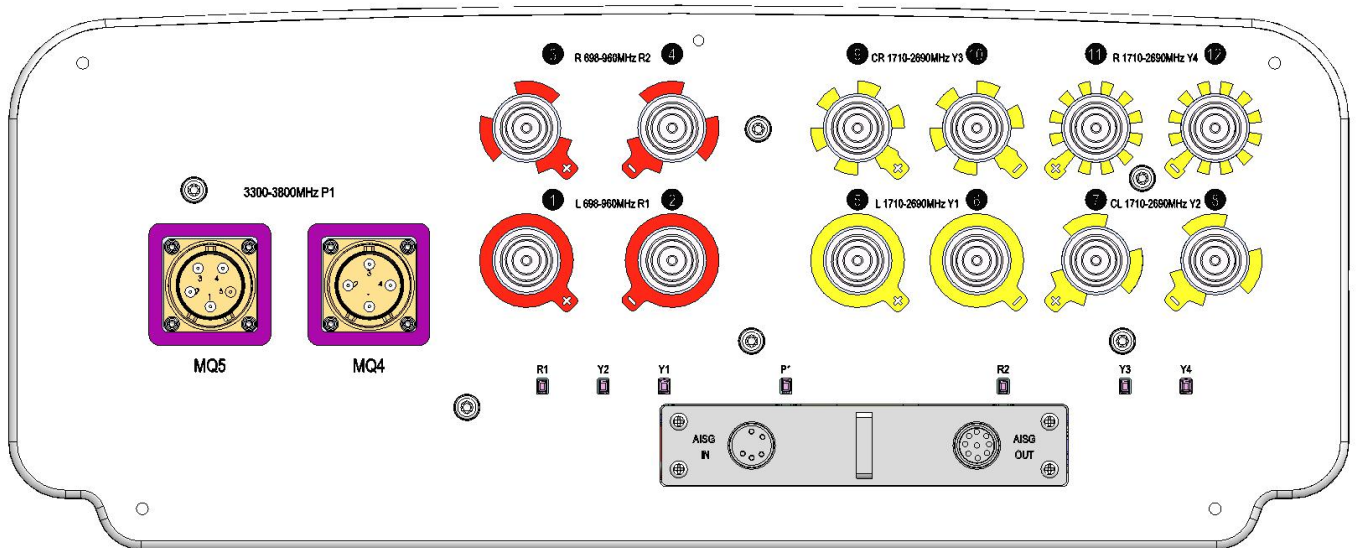

S-VU2L4PX10.5.5P-2C

Correlation Table

Frequency Range	Array	Connector
698-960 MHz	R1	1-2
698-960 MHz	R2	3-4
1710-2690 MHz	Y1	5-6
1710-2690 MHz	Y2	7-8
1710-2690 MHz	Y3	9-10
1710-2690 MHz	Y4	11-12
3300-3800 MHz	P1	MQ5, MQ4

3300-3800 Port Mapping

Connector	Frequency	Polarization/Port
MQ5-1	3300-3800 MHz	+45
MQ5-2	3300-3800 MHz	+45
MQ5-3	3300-3800 MHz	+45
MQ5-4	3300-3800 MHz	+45
MQ4-1	3300-3800 MHz	-45
MQ4-2	3300-3800 MHz	-45
MQ4-3	3300-3800 MHz	-45
MQ4-4	3300-3800 MHz	-45
MQ5-5	3300-3800 MHz	Calibration port

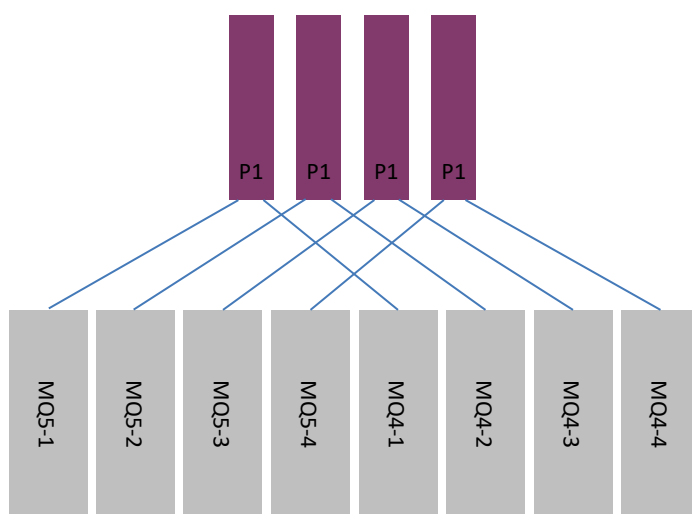
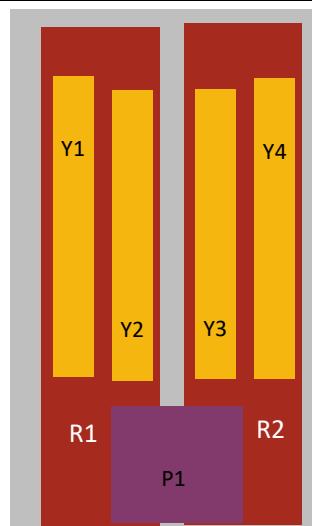

S-VU2L4PX10.5.5P-2C**Broadcast Beam Weight Value for Reference**

	Port	MQ5-1/ MQ4-1	MQ5-2/ MQ4-2	MQ5-3/ MQ4-3	MQ5-4/ MQ4-4
2C(3300-3800MHz)	Amp[li]	0.31	1	0.63	0.1
	Phase	170	-10	0	-20
3C(3300-3800MHz)	Amp[li]	0.31	1	0.63	0.1
	Phase	170	-6	0	-16
4C(3300-3800MHz)	Amp[li]	0.31	1	0.63	0.1
	Phase	170	-2	0	-12
5C(3300-3800MHz)	Amp[li]	0.31	1	0.63	0.1
	Phase	170	2	0	-8
6C(3300-3800MHz)	Amp[li]	0.31	1	0.63	0.1
	Phase	170	6	0	-4
7C(3300-3800MHz)	Amp[li]	0.31	1	0.63	0.1
	Phase	170	10	0	0
8C(3300-3800MHz)	Amp[li]	0.31	1	0.63	0.1
	Phase	170	14	0	4
9C(3300-3800MHz)	Amp[li]	0.31	1	0.63	0.1
	Phase	170	18	0	8
10C(3300-3800MHz)	Amp[li]	0.31	1	0.63	0.1
	Phase	170	22	0	12
11C(3300-3800MHz)	Amp[li]	0.31	1	0.63	0.1
	Phase	170	26	0	16
12C(3300-3800MHz)	Amp[li]	0.31	1	0.63	0.1
	Phase	170	30	0	20

Product Data Sheet

S-HPX0410P-E2-C

X Pol Panel TD Antenna 2300-2690MHz 65° 17dBi 2°-12° Replaceable RET

General Electrical Properties			
General Parameters	Frequency Range (MHz)	2300-2400(Y1)	2500-2690(Y1)
	Polarization	±45	
	Electrical Downtilt (°)	2-12, continuously adjustable	
	Lightning Grounding	DC Grounded	
Calibration and Electrical Parameters	Coupling Factor between calibration port and each antenna port (dB)	-26±2	
	Max Amp/Phase Deviation:	≤1.2/12°	
	VSWR:	≤1.5	
	Co- polarization Isolation between ports (dB):	≥20@2T-6T, ≥25@7T-12T	
	Cross-polarization Isolation Between Ports (dB):	≥25	
Avg. power per input(W)	≥150		

Beamforming Electrical Properties				
Radiation parameters	Frequency Range (MHz)		2300-2400(Y1)	2500-2690(Y1)
	Single Column	Horizontal 3dB Beamwidth (°):	70±10	65±15
		Gain(dBi):	16.2±0.8	16.5±0.8
		Vertical 3dB Beamwidth (°):	6.8	6.0
		Cross Polar Ratio 0° (dB):	≥15	≥15
		Front to Back Ratio (dB):	≥24	≥24
		First upper Side lobe suppression (dB)	≥15	≥15
	Broadcast Beam	Gain(dBi):	16.2±0.8	16.5±0.8
		±32.5° SPR(%)	72±10	72±10
		±60° SPR(%)	≥90	≥90
		±60° Gain roll-off at sector edge (dB)	12±6	12±6
		Vertical 3dB Beamwidth (°):	6.8	6.0
		Front to Back Ratio (dB):	≥25	≥25
	Service Beam @ 0deg	First upper Side lobe suppression (dB)	≥15	≥15
		Gain(dB):	21.0±0.8	21.5±0.8
		Horizontal 3dB Beamwidth (°):	18	17
		Horizontal sidelobe level (°):	≤-12	≤-12
		Cross Polar Ratio 0° (dB):	≥18	≥18
	Service Beam@ ±60deg	Front to Back Ratio (dB):	≥26	≥26
		Gain(dB):	18.0±0.5	18.5±0.5
Horizontal 3dB Beamwidth (°):		22	20	
	Horizontal sidelobe level (°):	≤0	≤0	

Product Data Sheet

S-HPX0410P-E2-C

BASTA Electrical Specifications

	2300-2400(Y1)	2500-2690(Y1)
Average Gain by all Beam Tilts (dBi):	16.2	16.4
Gain by all Beam Tilts Tolerance(dB):	±0.4	±0.5
Average Gain by Beam Tilt (dBi):	2° 16.2 7° 16.4 12° 16.0	2° 16.3 7° 16.6 12° 16.2
Horizontal Beamwidth Tolerance(°):	±5.7	±6.8
Vertical Beamwidth Tolerance(°):	±0.3	±0.4
1st Upper Sidelobe Suppression (dB) :	15.5	15.1
Front to back Total Power at 180° ± 30°(dB):	30.1	29.6
CPR at Boresight(dB):	23.3	22.7

Mechanical Data

Mechanical Data	
Antenna Dimensions (mm):	1500×370×124
Packing Dimensions (mm):	1820×455×220
Antenna Net Weight/Bracket (kg):	18.6/5.9
Antenna Gross Weight (kg):	28
Connector Type:	8+1(Cal)4.3-10 female
Radome Material:	Fiberglass
Pipe OD (mm):	50-114
Mounting Kits (Included):	BA.K.04.00069141, Adjustable Downtilt 0°-18°
Humidity:	95%RH@+30°C
Temperature (°C):	-40~+70
Wind Load @150 km/h (N):	Frontal/Lateral/Rearside:797/98/650
Max. Wind velocity(km/h)	200

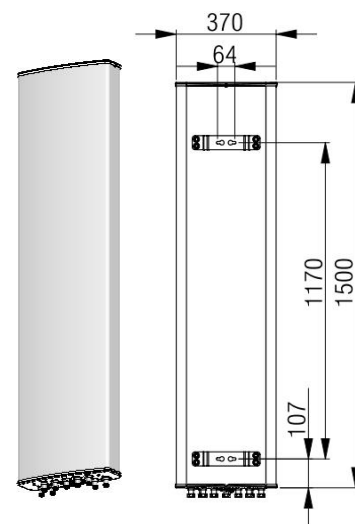

Internal RET Specifications

RET Type:	Replaceable RET
RET protocol:	AISG2.0 /3GPP
Input voltage range(V):	10-30 DC
Power consumption(W):	< 5 (motor activated, single RET) < 1 (stand by, single RET), < 1.5 (stand by, 12V)
Adjustment Time (Full Range) (s):	< 120 (typically, depending on antenna type)
RET Connector:	1 pair of AISG 5 pin male & female
Pin assignment according AISG:	8pin circular connector conforming to IEC 60130-9 - Ed. 3.0
Lightning protection (kA):	5 (8/20 μs Differential mode), 8 (8/20 μs Common mode)

Typical Patterns

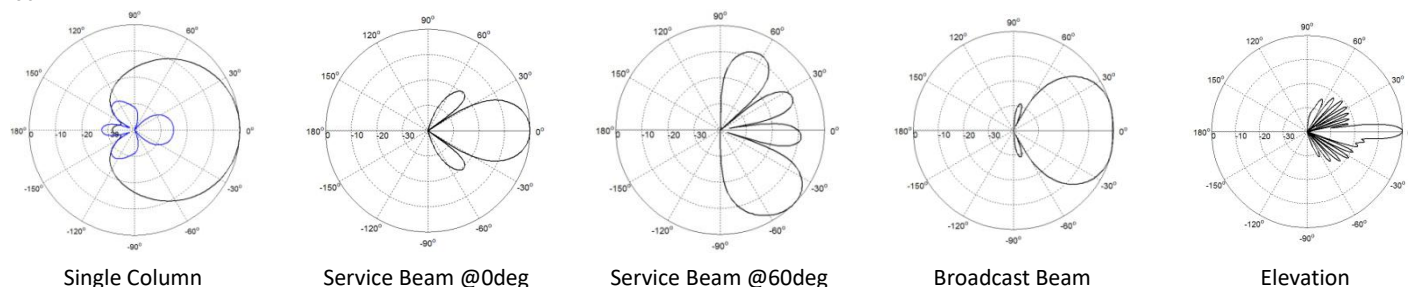

S-HPX0410P-E2-C

Bottom View



Correlation Table

Frequency Range	Array	Connector	RET
2300-2690MHz	Y1	1-8	BRxxx.....Y1

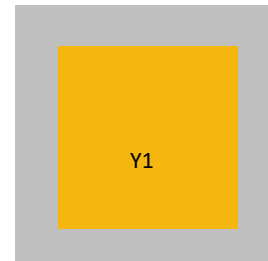

S-HU2PX10.6P-E2-C

X Pol Panel TD Antenna 2300-2690MHz 90° 15.0dBi 2°-12° Replaceable RET

XX Pol Panel Antenna 2×690-960MHz 65° 14.0dBi 2°-12° Replaceable RET

General Electrical Properties		
General Parameters	Frequency Range (MHz)	2300-2690(Y1)
	Polarization	±45°
	Electrical Downtilt (°)	2-12, continuously adjustable
	Lightning Grounding	DC Grounded
Calibration and Electrical Parameters	Coupling Factor between calibration port and each antenna port (dB)	-26±2
	Max Amp/Phase Deviation:	≤1.0/ 11°
	VSWR:	≤1.5
	Co- polarization Isolation between ports (dB):	≥21
	Cross-polarization Isolation Between Ports (dB)	≥21
	Avg. power per input(W):	≥150
Connector Type:		9×4.3-10 Female

Beamforming Electrical Properties				
	Frequency Range (MHz)		2300-2400	2400-2690
	Radiation parameters	Single Column	Horizontal 3dB Beamwidth (°):	90
Gain(dBi):			14.7±0.5	14.7±0.5
Vertical 3dB Beamwidth (°):			6.7	6.2
Cross Polar Ratio 0° (dB):			≥14	≥14
Front to Back Ratio (dB):			≥23	≥23
First upper Side lobe suppression (dB)			≥13	≥13
Broadcast Beam		Horizontal 3dB Beamwidth (°):	65±10	65±10
		Gain(dBi):	16.5±1.0	17.0±1.0
		±60° Gain roll-off at sector edge (dB)	12±6	12±6
		Vertical 3dB Beamwidth (°):	6.7	6.2
		Cross Polar Ratio 0° (dB):	≥15	≥15
		Cross Polar Ratio ±60° (dB):	≥8	≥8
		Front to Back Ratio (dB):	≥23	≥23
First upper Side lobe suppression (dB)		≥13	≥13	
Service Beam @ 0deg		Gain(dBi):	20.0±1.0	20.5±1.0
		Horizontal 3dB Beamwidth (°):	24	23
		Horizontal sidelobe level (°):	≤-12	≤-12
		Cross Polar Ratio 0° (dB):	≥15	≥15
Service Beam@ ±60deg	Front to Back Ratio (dB):	≥23	≥23	
	Gain(dBi):	16.5±1.0	17.0±1.0	
	Horizontal 3dB Beamwidth (°):	26	25	
		Horizontal sidelobe level (°):	≤-3	≤-3

Product Data Sheet

S-HU2PX10.6P-E2-C

BASTA Electrical Specifications

Frequency Range(MHz):	2300-2400(Y1)	2500-2690(Y1)
Average Gain by all Beam Tilts (dBi):	14.7	14.7
Gain by all Beam Tilts Tolerance(dB):	±0.4	±0.4
Average Gain by Beam Tilt (dBi):	2° 14.5 7° 15.0 12° 14.6	2° 14.7 7° 15.0 12° 14.5
Horizontal Beamwidth Tolerance(°):	±15	±10
Vertical Beamwidth Tolerance(°):	±0.5	±0.5
1st Upper Sidelobe Suppression (dB) :	15.5	14.3
Front to back Total Power at 180° ± 30°(dB):	25	24
CPR at Boresight(dB):	19.5	19

Frequency Range (MHz) :	690-960(R1)			690-960(R2)		
	690-806	806-880	880-960	690-806	806-880	880-960
Gain (dBi) :	12.6±0.5	13.4±0.5	13.6±0.5	11.9±0.5	12.6±0.5	13.2±0.5
Return Loss (dB) :	>14 (VSWR<1.5)					
Polarization :	±45°					
Horizontal 3dB Beamwidth (°) :	65	60	58	66	61	57
Vertical 3dB Beamwidth (°) :	16.4	14.2	12.7	16.9	15.2	13.4
Electrical Downtilt (°) :	2-12 Independently Continuously Adjustable					
RET Type:	Cascade SRET, AISG 2.0, Upgradeable					
Intraband Isolation (dB):	>25					
Interband Isolation (dB):	>25					
Max. Power Per Port (W):	250					
Intermodulation IM3 (dBc):	<-150(2×43 dBm)					
Impedance (ohm):	50					
Lightning Protection:	DC Grounded					
Connector Type:	4×4.3-10Female					

BASTA Electrical Specifications

Frequency Range(MHz):	690-960(R1)			690-960(R2)		
	690-806	806-880	880-960	690-806	806-880	880-960
Average Gain by all Beam Tilts(dBi):	12.5	13.2	13.6	11.9	12.5	13.0
Gain by all Beam Tilts Tolerance(dB):	±0.2	±0.5	±0.7	±0.4	±0.6	±0.5
Average Gain by Beam Tilts (dBi):	2° 12.6 7° 12.5 12° 12.4	2° 13.3 7° 13.4 12° 12.9	2° 13.6 7° 13.6 12° 13.4	2° 11.9 7° 11.9 12° 11.7	2° 12.6 7° 12.5 12° 12.2	2° 13.2 7° 13.1 12° 12.7
Horizontal Beamwidth Tolerance(°):	±4.3	±4.2	±4.5	±5.0	±6.4	±8.0
Vertical Beamwidth Tolerance(°):	±1.2	±0.9	±0.7	±1.6	±1.2	±1.0
1 st Upper Sidelobe Suppression(dB):	17.3	16.9	13.8	15.0	17.0	14.5
Front to back Total Power at 180° ± 30°(dB)	21.3	21.7	24.9	21.1	22.7	22.9
CPR at Boresight(dB):	17.3	19.3	21.8	20.6	18.7	23.7
CPR at Sector(dB):	6.5	6.0	10.8	9.6	7.2	7.0



S-HU2PX10.6P-E2-C

Mechanical Data	
Antenna Dimensions (mm):	2095×448×145
Packing Dimensions (mm):	2365×535×240
Antenna Net Weight/Bracket (kg):	30/5.9
Antenna Gross Weight (kg):	42
Radome Material:	Fiberglass
Pipe OD (mm):	50-115
Mounting Kits (Included):	BA.K.04.00069101, Adjustable Downtilt 0°-12°
Humidity:	95%RH@+30°C
Temperature (°C):	-40~+70
Wind Load @150 km/h (N):	Frontal/Lateral/Rearside: 1200/174/1314
Max. Wind velocity(km/h):	200

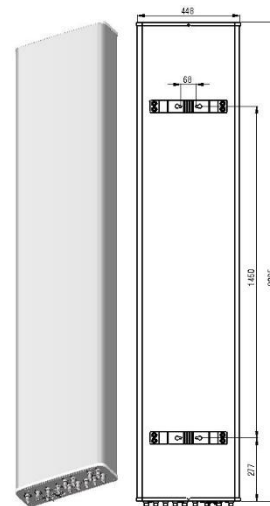

Internal RET Specifications

RET type:	Replaceable RET
RET protocol:	AISG2.0 /3GPP
Input voltage range(V):	10-30 DC
Power consumption(W):	< 5 (motor activated, single RET) < 1 (stand by, single RET), < 1.5 (stand by, 12V)
Adjustment time (full range): (s):	< 120 (typically, depending on antenna type)
RET connector:	1 pair of AISG 5 pin male & female
Pin assignment according AISG:	8-pin circular connector conforming to IEC 60130-9 - Ed. 3.0
Lightning protection (kA):	5 (8/20 μs Differential mode), 8 (8/20 μs Common mode)

Typical Patterns

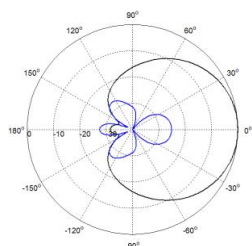

Single Column

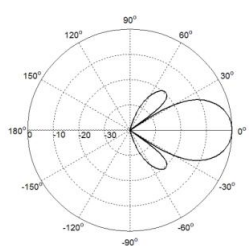

Service Beam @0deg

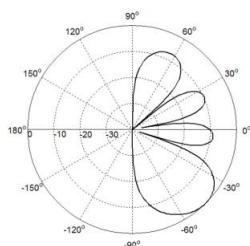

Service Beam @60deg

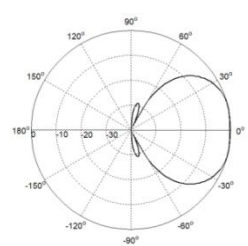

Broadcast Beam

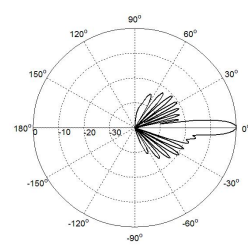

Elevation

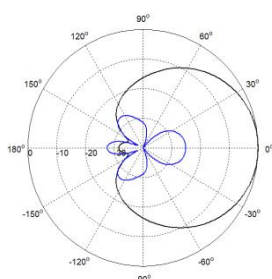

Azimuth(690-960MHz)

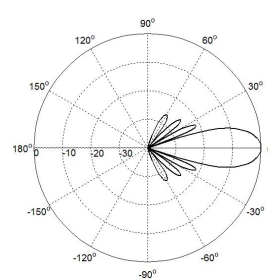

Elevation(690-960MHz)

S-HU2PX10.6P-E2-C

Bottom View

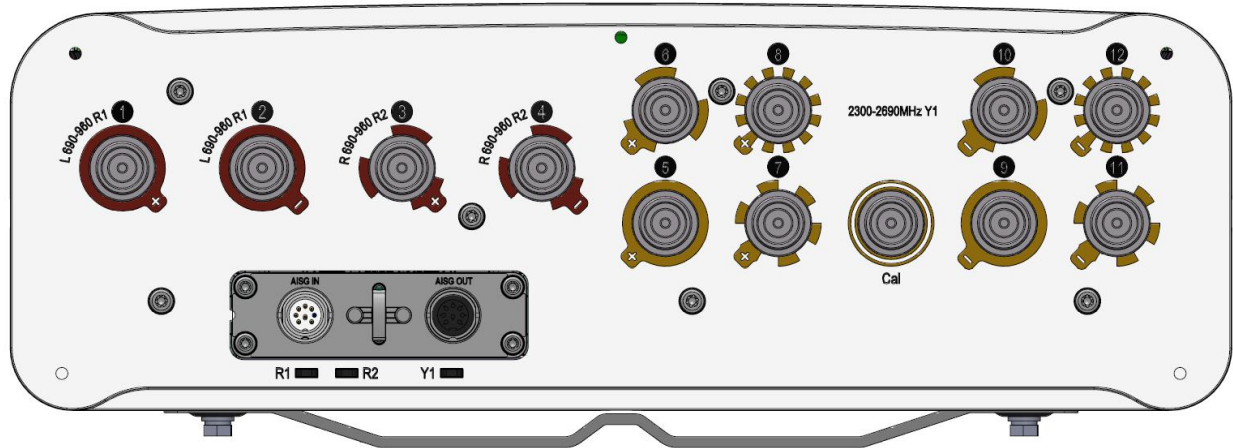

Correlation Table

Frequency Range	Array	Connector
690–960 MHz	R1	1-2
690– 960 MHz	R2	3-4
2300–2690 MHz	Y1	5-12

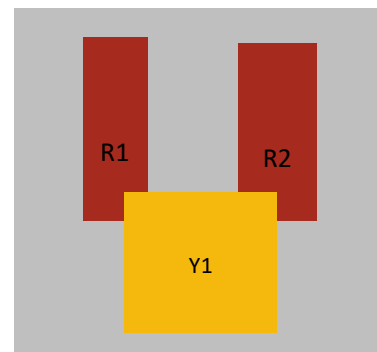

S-HU2L2PX308.9P-DH2-2C

X Pol Panel TD Antenna 2500-2690MHz 65° 14.5dBi 2°-12° Replaceable RET

XXXXXX Pol Panel Antenna 2×698-960/2×1710-2170/2×2500-2690MHz 65°/65°/65° 15/16.5/17dBi
2°-12°/2°-12°/2°-12° Replaceable RET

General Electrical Properties		
General Parameters	Frequency Range (MHz)	2500-2690(Y3)
	Polarization	±45°
	Electrical Downtilt (°)	2-12 , continuously adjustable
	Lightning Grounding	DC Grounded
Calibration and Electrical Parameters	Coupling Factor between calibration port and each antenna port	-26±2
	Max Amp/Phase Deviation:	≤1.0/ 10°
	VSWR:	≤1.5
	Co- polarization Isolation between ports (dB):	≥20
	Cross-polarization Isolation Between Ports (dB)	≥20
	Avg. power per input(W)	≥150
Connector Type:	9x4.3-10 Female	

Beamforming Electrical Properties			
Radiation parameters	Frequency Range (MHz)		2500-2690(Y3)
	Single Column	Horizontal 3dB Beamwidth (°):	73±10
		Gain(dBi):	14.5±1
		Vertical 3dB Beamwidth (°):	7.5
		Cross Polar Ratio 0° (dB):	≥15
		Front to Back Ratio (dB):	≥23
		First upper Side lobe suppression (dB)	≥11
	Broadcast Beam	Horizontal 3dB Beamwidth (°):	65±10
		Gain(dBi):	16.2±0.5
		±60° Gain roll-off at sector edge (dB)	12±6
		Vertical 3dB Beamwidth (°):	7.5
		Cross Polar Ratio 0° (dB):	≥13
		Cross Polar Ratio ±60° (dB):	≥4
		Front to Back Ratio (dB):	≥23
	First upper Side lobe suppression (dB)	≥13	
	Service Beam @ 0deg	0° Gain(dB):	19.5±0.5
		0° Horizontal 3dB Beamwidth (°):	23
		0° Horizontal sidelobe level (°):	≤-12
		Cross Polar Ratio 0° (dB):	≥15
		Front to Back Ratio (dB):	≥23

Product Data Sheet

S-HU2L2PX308.9P-DH2-2C

BASTA Electrical Specifications

Frequency Range(MHz):	2500-2690(Y3)
Average Gain by all Beam Tilts (dBi):	14.5
Gain by all Beam Tilts Tolerance(dB):	±1.0
Average Gain by Beam Tilt (dBi):	2° 14.5
Horizontal Beamwidth Tolerance(°):	±9.0
Vertical Beamwidth Tolerance(°):	±0.5
1st Upper Sidelobe Suppression (dB) :	13.0
Front to back	27
Total Power at 180° ± 30°(dB):	
CPR at Boresight(dB):	19

Frequency Range (MHz) :	698-960(R1,R2)			1710-2170(B1,B2)			2500-2690 (Y1,Y2)
	698-790	790-862	880-960	1710-1880	1880-2025	2025-2170	
Gain (dBi):	13.7±0.5	14.0±0.5	14.6±0.7	14.9±0.5	14.7±0.5	14.7±0.5	15.5±0.7
Return Loss (dB) :	>14 (VSWR<1.5)						
Polarization:	±45°						
Horizontal 3dB Beamwidth (°):	66	65	63	65	67	65	59
Vertical 3dB Beamwidth (°):	12	11	9.7	8.0	7.7	6.8	5.6
Electrical Downtilt (°) :	2-12 Independently Continuously Adjustable						
Intraband Isolation (dB):	>25						
Interband Isolation (dB):	>25						
Intermodulation IM3 (dBc):	250			200			
Impedance (ohm):	<-150						
Lightning Protection:	50						
Connector Type:	DC Grounded						
Intermodulation IM3 (dBc):	12×4.3-10 Female						

BASTA Electrical Specifications

Frequency Range(MHz):	690-960(R1,R2)			1710-2170(B1,B2)			2500-2690 (Y1,Y2)
	690-806	806-880	880-960	1710-1880	1880-2025	2025-2170	
Average Gain by all Beam Tilts(dBi):	13.5	13.8	14.4	14.8	14.5	14.5	15.1
Gain by all Beam Tilts Tolerance(dB):	±0.8	±0.9	±0.6	±1.0	±0.9	±1.0	±0.7
Average Gain by Beam Tilts (dBi):	2° 13.5	2° 13.6	2° 14.4	2° 14.9	2° 14.5	2° 14.7	2° 15.2
	7° 13.7	7° 14.0	7° 14.6	7° 14.8	7° 14.7	7° 14.7	7° 15.5
	12° 13.4	12° 13.7	12° 14.3	12° 14.5	12° 14.1	12° 14.0	12° 14.7
Horizontal Beamwidth Tolerance(°):	±7.0	±7.5	±6.0	±7.2	±7.0	±9.8	±8
Vertical Beamwidth Tolerance(°):	±1.2	±1.0	±1.0	±0.9	±0.6	±0.8	±0.5
1 st Upper Sidelobe Suppression(dB):	13	13	14	15	16	14	17
Front to back Total Power at 180° ±	20	20	22	24	24	25	24
CPR at Boresight(dB):	20	18	18	15	18	18	19
CPR at Sector(dB):	11	9	10	5	4	4	5



S-HU2L2PX308.9P-DH2-2C

Mechanical Data	
Antenna Dimensions (mm):	2095×448×200
Packing Dimensions (mm):	2360×535×295
Antenna Net Weight/Bracket (kg):	42 / 6.8
Antenna Gross Weight (kg):	55.5
Radome Material:	FRP
Pipe OD (mm):	50-125
Mounting Kits (Included):	Adjustable Downtilt 0°-12°
Humidity:	95%RH@+30℃
Temperature (℃):	-40~+70
Wind Load @150 km/h (N):	Frontal/Lateral/Rearside: 1214/290/1314
Max. Wind velocity(km/h):	200

Internal RET Specifications

RET type:	Replaceable RET
RET protocol:	AISG2.0 /3GPP
Input voltage range(V):	10-30 DC
Power consumption(W):	< 5 (motor activated, single RET) < 1 (stand by, single RET), < 1.5 (stand by, 12V)
Adjustment time (full range): (s):	< 120 (typically, depending on antenna type)
RET connector:	1 pair of AISG 5 pin male & female
Pin assignment according AISG:	8-pin circular connector conforming to IEC 60130-9 - Ed. 3.0
Lightning protection (kA):	5 (8/20 μs Differential mode), 8 (8/20 μs Common mode)

Typical Patterns

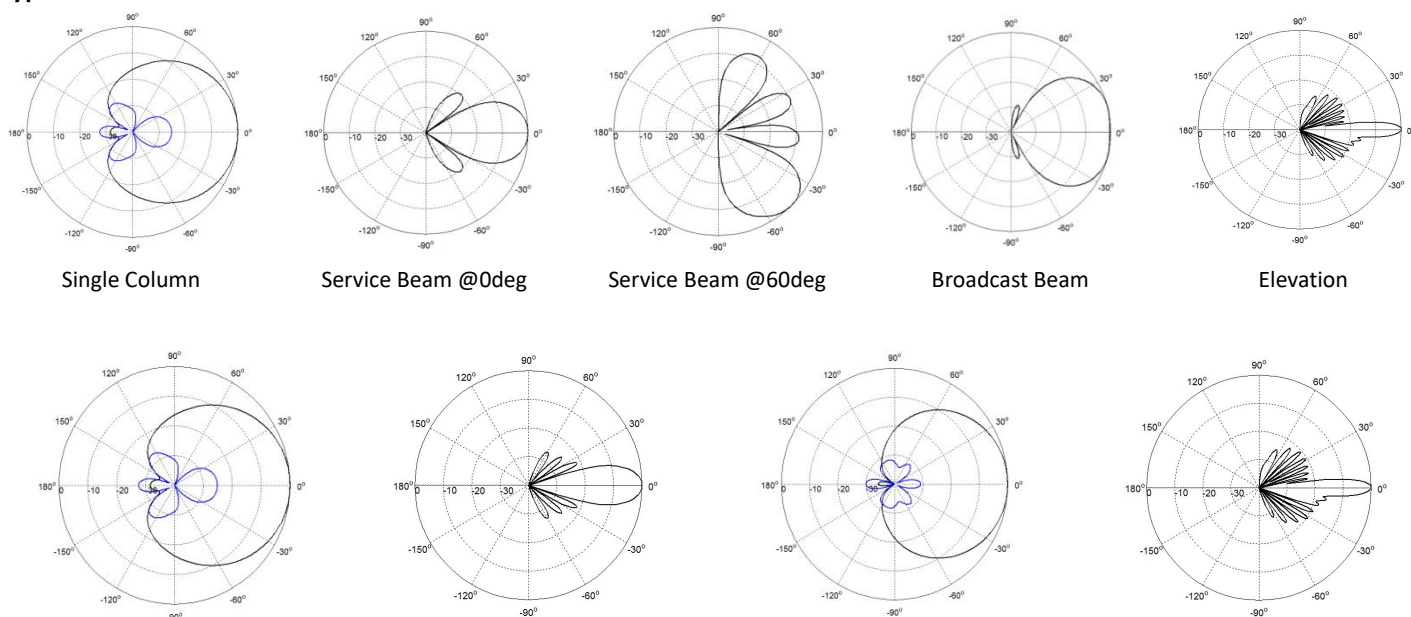

S-HU2L2PX308.9P-DH2-2C

Bottom View

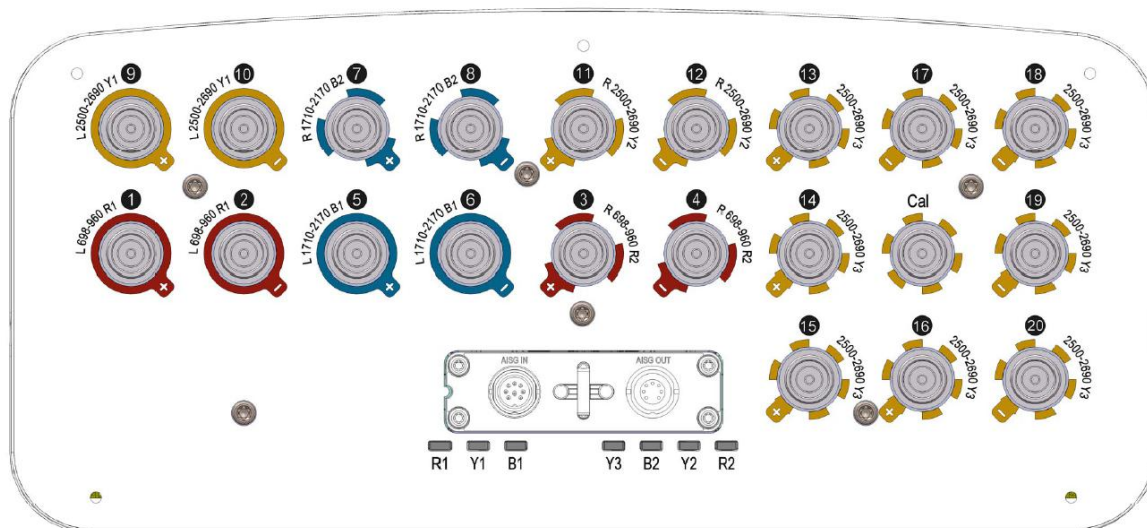

Correlation Table

Frequency range	Array	Connector	RET S/N
698–960 MHz	R1	1-2	BRxxx.....1R1
698–960 MHz	R2	3-4	BRxxx.....2R2
1710–2170 MHz	B1	5-6	BRxxx.....3B1
1710–2170 MHz	B2	7-8	BRxxx.....4B2
2500–2690 MHz	Y1	9-10	BRxxx.....5Y1
2500–2690 MHz	Y2	11-12	BRxxx.....6Y2
2500–2690 MHz	Y3	13-21	BRxxx.....7Y3

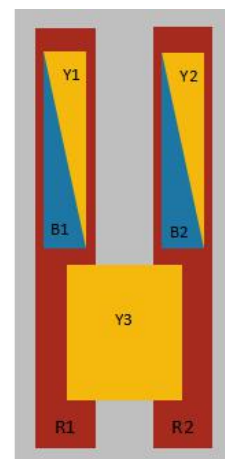

S-HU2L4PX10.10.12P-E2-C

X Pol Panel TD Antenna 2300-2690MHz 90° 15.5dBi 2°-12° Replaceable RET

XXXXXX Pol 2×698-960/4×1710-2690MHz 65°/65° 16/18dBi 2°-12°/2°-12° Replaceable RET

Electrical Specifications (2300-2690MHz)

Electrical Specifications (2300-2690MHz)			
General parameters	Frequency range (MHz):		2300-2690(Y5)
	Polarization:		±45
	Electrical downtilt (°):		2-12, continuously adjustable
	Grounding:		DC Grounded
	Connector Type:		1xMQ5,1xMQ4
Calibration and electrical parameters	Coupling factor between calibration port and each antenna port (dB) :		-26±2
	Max Amp/phase Deviation:		<1.2dB/12°
	VSWR:		<1.5
	Max. Power Per Port (W):		150
	Isolation (dB):		>20
Radiation parameters	Single Column	Horizontal 3dB Beamwidth (°):	80±20
		Vertical 3dB Beamwidth (°):	7
		Front to Back Ratio (dB):	>23
		Gain (dBi):	15.3±0.5
		Cross polar ratio (dB):	>13 (0°)/ >5 (±60°)
	Broadcast Beam	Horizontal 3dB Beamwidth (°):	65±10
		Gain (dBi):	16.5±0.5
		Front to Back Ratio (dB):	25
		Vertical 3dB Beamwidth (°):	7
		Cross polar ratio (dB):	>15 (0°)/ >8 (±60°)
	Service Beam @ 0deg	1 st Upper Sidelobe Suppression (dB):	>14
		Gain (dBi):	20±0.5
		Horizontal 3dB Beamwidth (°):	25
		Horizontal Sidelobe Level (dB):	<-12
		Cross polar ratio (0°) (dB):	18
	Front to Back Ratio (dB):	25	

Product Data Sheet

S-HU2L4PX10.10.12P-E2-C

Electrical Specifications (698-960/1710-2690 MHz)

Frequency Range (MHz):	698-960(R1,R2)			1710-2690(Y2,Y3)			1710-2690(Y1,Y4)		
	698-806	806-880	880-960	1710 -2170	2300 -2490	2490 -2690	1710 -2170	2300 -2490	2490 -2690
Gain (dBi):	15.0 ±0.5	15.6 ±0.5	16.0 ±0.5	16.2 ±0.8	17.5 ±0.5	17.8 ±0.5	16.1 ±0.8	17.6 ±0.5	18.0 ±0.5
Return Loss (dB):	>14 (VSWR<1.5)								
Polarization:	±45°								
Horizontal 3dB beamwidth (°):	71	65	60	64	60	59	68	61	61
Vertical 3dB beamwidth (°):	9	8	7.5	6	5	4.5	6	5	4.5
Electrical Downtilt (°):	2-12 Independently Continuously Adjustable			2-12 Independently Continuously Adjustable					
Front to Back Ratio @180±30° (dB):	22	23	23	23	25	25	23	25	25
1 st Upper Sidelobe Suppression (dB):	15	16	16	13	15	15	13	16	15
Cross Polar Ratio 0° (dB):	15	15	15	14	15	15	14	15	15
Intraband Isolation (dB):	>25								
Interband Isolation (dB):	>25								
Max. Power Per Port (W):	250			200					
Intermodulation IM3 (dBc):	<-150 (2×43dBm)								
Impedance (ohm):	50								
Lightning Protection:	DC Grounded								
Connector Type:	12x4.3-10 Female								

Mechanical Data

Antenna Dimensions (mm):	2695×498×197
Packing Dimensions (mm):	2925×585×290
Antenna Net Weight/Bracket (kg):	53.5/5.7
Antenna Gross Weight (kg):	66
Radome Material:	Fiberglass
Pipe OD (mm):	70-114
Mounting Kits (Included):	BA.K.04.00069471, Adjustable Downtilt0-8(0°-8°in 1°steps)



Environmental Ratings

Humidity:	95%RH@+30°C
Temperature (°C):	-40~+70
Wind Load @150 km/h (N):	Frontal/Lateral/Rearside: 1763/324/1788
Max. Wind velocity (km/h):	200

Internal RET Specifications

RET type:	Replaceable RET
RET protocol:	AISG2.0 /3GPP
Input voltage range(V):	10-30 DC
Power consumption(W):	< 5 (motor activated ,single RET) < 1 (stand by,single RET), < 1.5 (stand by, 12V)
Adjustment time (full range) (s):	< 120 (typically, depending on antenna type)
RET connector:	1 pair of AISG 5 pin male & female
Pin assignment according AISG:	8 pin circular connector conforming to IEC 60130-9 - Ed. 3.0
Lightning protection (kA):	5 (8/20 μs Differential mode), 8 (8/20 μs Common mode)

S-HU2L4PX10.10.12P-E2-C

Typical Patterns

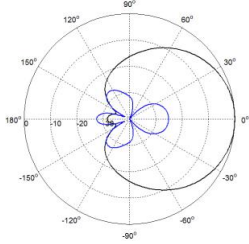

Single Column

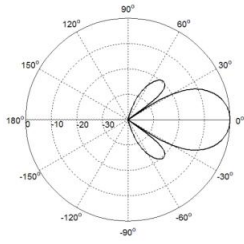

Service Beam @0deg

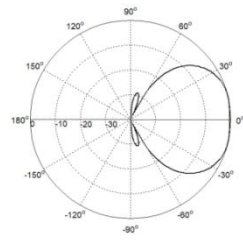

Broadcast Beam

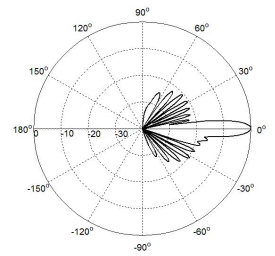

Elevation

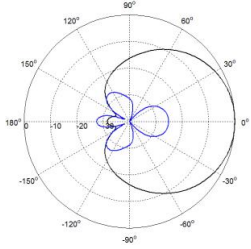

Azimuth(698-960MHz)

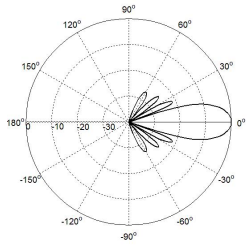

Elevation(698-960MHz)

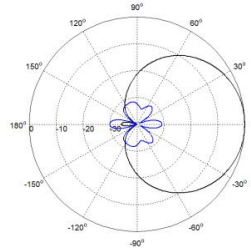

Azimuth(1710-2690MHz)

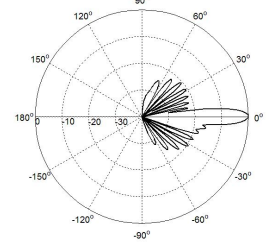

Elevation(1710-2690MHz)

Bottom View

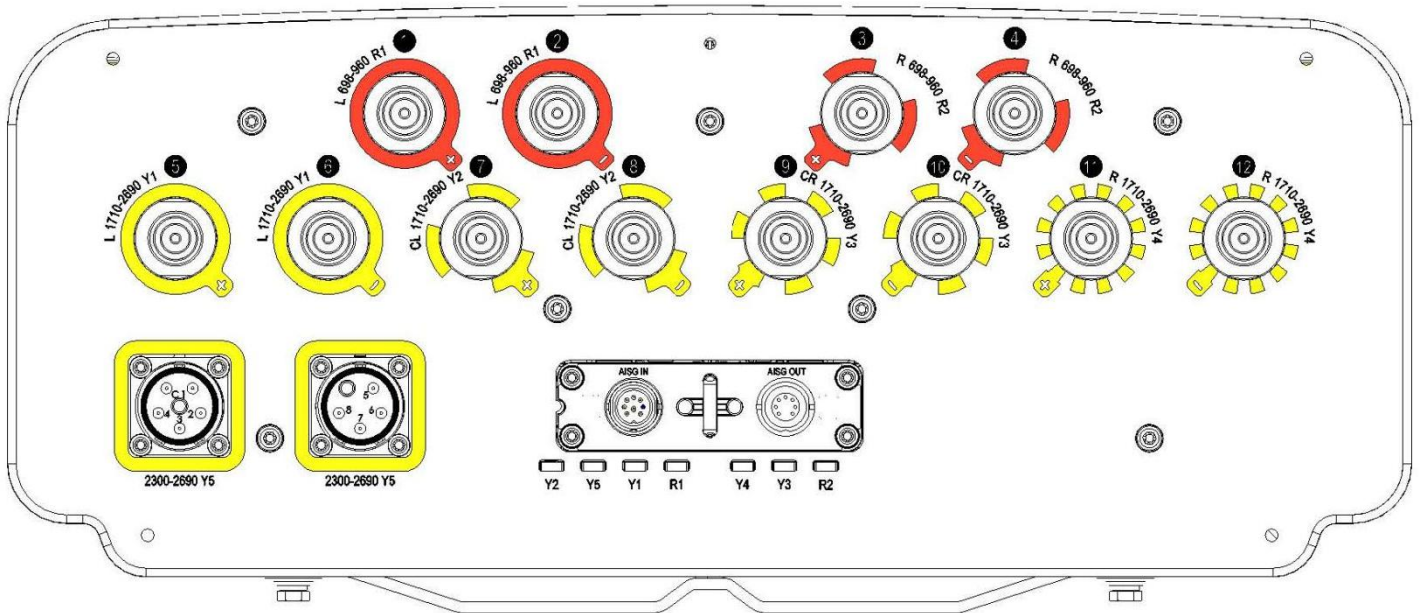

S-HU2L4PX10.10.12P-E2-C

Correlation Table

Frequency Range	Array	Connector
698–960 MHz	R1	1-2
698–960 MHz	R2	3-4
1710–2690 MHz	Y1	5-6
1710–2690 MHz	Y2	7-8
1710–2690 MHz	Y3	9-10
1710–2690 MHz	Y4	11-12
2300-2690 MHz	Y5	1xMQ5,1xMQ4

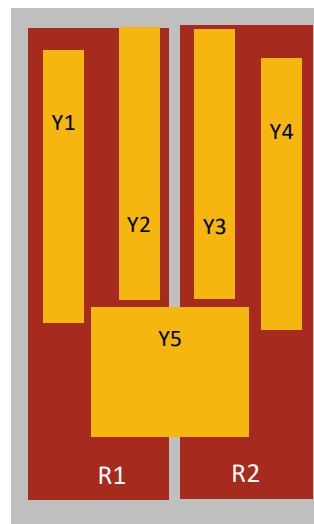

2300-2690 Port Mapping

Connector	Frequency	Polarization/Port
MQ5-1	2300-2690 MHz	+45
MQ4-5	2300-2690 MHz	-45
MQ5-2	2300-2690 MHz	+45
MQ4-6	2300-2690 MHz	-45
MQ5-3	2300-2690 MHz	+45
MQ4-7	2300-2690 MHz	-45
MQ5-4	2300-2690 MHz	+45
MQ4-8	2300-2690 MHz	-45
MQ5-C	2300-2690 MHz	Calibration port

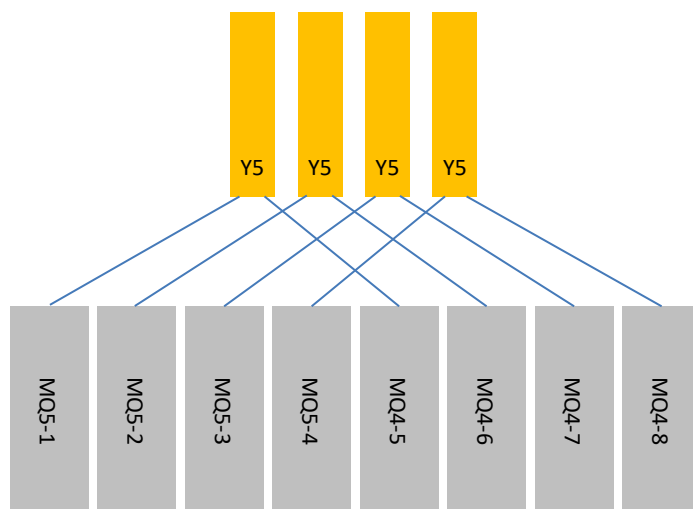

S-HU2L4PX10.10.12P-E2-C**Broadcast Beam Weight Value for Reference**

		MQ5-1/ MQ4-5	MQ5-2/ MQ4-6	MQ5-3/ MQ4-7	MQ5-4/ MQ4-8
2C(2300-2690MHz)	Amp[li]	0.68	1	1	0.51
	Phase	-165	0	15	0
3C(2300-2690MHz)	Amp[li]	0.68	1	1	0.51
	Phase	-168	0	12	0
4C(2300-2690MHz)	Amp[li]	0.68	1	1	0.51
	Phase	-171	0	9	0
5C(2300-2690MHz)	Amp[li]	0.68	1	1	0.51
	Phase	-174	0	6	0
6C(2300-2690MHz)	Amp[li]	0.68	1	1	0.51
	Phase	-177	0	3	0
7C(2300-2690MHz)	Amp[li]	0.68	1	1	0.51
	Phase	180	0	0	0
8C(2300-2690MHz)	Amp[li]	0.68	1	1	0.51
	Phase	177	0	-3	0
9C(2300-2690MHz)	Amp[li]	0.68	1	1	0.51
	Phase	174	0	-6	0
10C(2300-2690MHz)	Amp[li]	0.68	1	1	0.51
	Phase	171	0	-9	0
11C(2300-2690MHz)	Amp[li]	0.68	1	1	0.51
	Phase	168	0	-12	0
12C(2300-2690MHz)	Amp[li]	0.68	1	1	0.51
	Phase	165	0	-15	0